



UNESCO-IHE  
Institute for Water Education



# Valorization of wastes from dairy farms using low-cost wastewater treatment technologies

## MSc Thesis

Qco. Guillermo Zinola

MSc student: 46834

May 2016

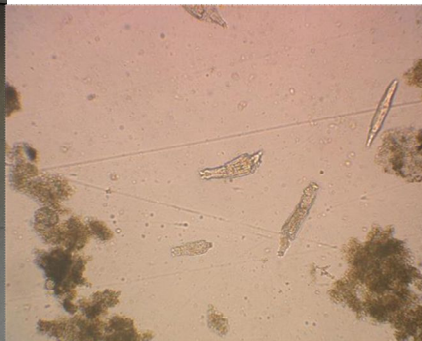
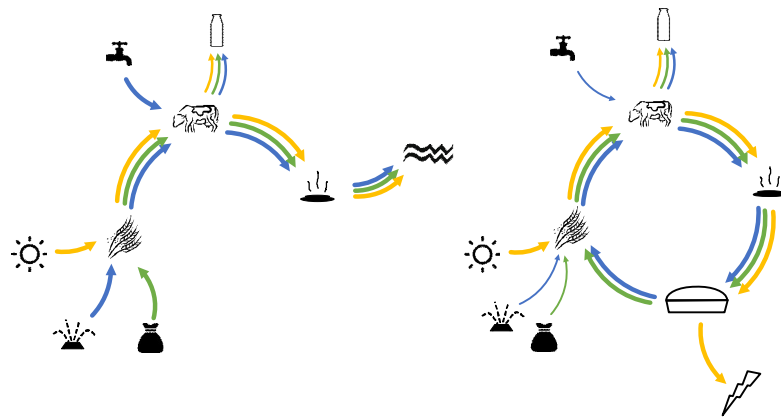
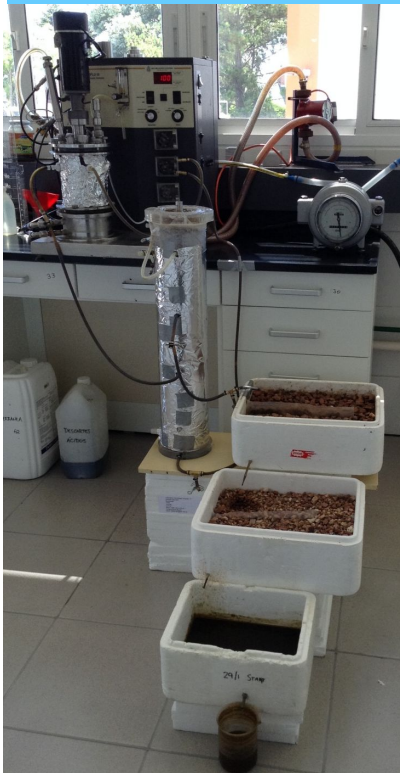



# **Valorization of wastes from dairy farms using low-cost wastewater treatment technologies**

Master of Science Thesis  
by  
**Qco. Guillermo Zinola**

Supervisors  
**Dr. Carlos Madera**

Mentors  
**PhD. MSc. Tineke Hooijmans**  
**PhD. MSc. Hector Garcia**

Examination committee  
**PhD. Diana Míguez**

This research is done for the partial fulfilment of requirements for the Master of Science degree at the UNESCO-IHE Institute for Water Education, Delft, the Netherlands

**Delft**  
**May 2016**

Although the author and UNESCO-IHE Institute for Water Education have made every effort to ensure that the information in this thesis was correct at press time, the author and UNESCO-IHE do not assume and hereby disclaim any liability to any party for any loss, damage, or disruption caused by errors or omissions, whether such errors or omissions result from negligence, accident, or any other cause.

© Guillermo Zinola, 2016.

This work is licensed under a [Creative Commons Attribution-NonCommercial 4.0 International License](https://creativecommons.org/licenses/by-nc/4.0/).



# Abstract

The main objective of this thesis was to develop a low-cost valorization system to treat and recover nutrients, water and energy from wastewater produced in the Uruguayan dairy farms. The characteristics of the sector in Uruguay refine the technologies to be applied, being the anaerobic digestion the key for the valorization system.

The effluent characterization and the study of the codigestion of this wastewater with crude glycerol were done to predict the behaviour in a full-scale system. A lab-scale reactor was used to model the stoichiometry and the kinetic of the anaerobic digestion process. Low-costs secondary and tertiary treatments were implemented to achieve the fertilization standards and the recycle of the effluent. Consequently, the 52 % of the groundwater for cleaning process in the dairy farm was saved by this recycle.

The results obtained in the lab-scale experiments allowed to design a full-scale system for a medium-scale farm. Economical profitability evaluation of the valorization system was done based in the lab-scale results and the full-scale design. The codigestion of the effluent of the farm with crude glycerol increased the energy production in 87 % considering the initial condition. The complete lab-scale system had high removal efficiencies of the influent fluxes in the water line, as 99.1 % of the Chemical Oxygen Demand (COD), 99.9 % of the Total Suspended Solids (TSS), 95.9 % of the Total Nitrogen (TN), 98.1 % of Total Phosphorous (TP) and 4 Log of the Faecal Coliforms (FC). Therefore this low-costs system could be an interesting valorization system for the small- and medium-scale dairy farms.



# Acknowledgements

I would like to express my deeper gratitude to my mates in this program, the dear Uruguayan mafia and Rodri; to the personnel of LATU and of the Facultad de Química, the farmers, and to my mentors to support me in this project. To my friends and family, and especially to my partner in the life.

*A todos, millones de gracias!*





# Table of Contents

<b>Abstract</b>	<b>i</b>
<b>Acknowledgements</b>	<b>iii</b>
<b>Table of Contents</b>	<b>v</b>
<b>List of Figures</b>	<b>vii</b>
<b>List of Tables</b>	<b>ix</b>
<b>Abbreviations</b>	<b>x</b>
<b>CHAPTER 1</b>	<b>1</b>
<b>Introduction</b>	<b>1</b>
1.1. Problem statement	1
1.1.1. Dairy farms in Uruguay	1
1.1.2. Natural resource pollution	4
1.2. Justification and significance of the proposed project	7
1.2.1. Environmental impacts	7
1.2.2. Water, energy and nutrient recycles	9
1.2.3. Community	12
1.2.4. Low-cost technologies	12
1.2.5. Potential applicability and feasibility	14
1.3. Research question and objectives	15
1.3.1. General objective	15
1.3.2. Specific objectives	15
<b>CHAPTER 2</b>	<b>16</b>
<b>Background</b>	<b>16</b>
2.1. Sustainable development and cleaner production	16
2.2. Wastewater characterisation	18
2.2.1. Dairy farm residues	18
2.2.2. Biodiesel by-products	19
2.3. Technology selection	20
2.3.1. Industrial effluent treatment technologies	20
2.3.2. Anaerobic digestion	22
2.3.3. Nitrogen removal	25
2.3.4. Pathogens removal	27
2.4. Feasibility	27
2.4.1. Technological risks	27
2.4.2. Economical risks	28
<b>CHAPTER 3</b>	<b>30</b>
<b>Methodology and materials</b>	<b>30</b>
3.1. Content overview	30

3.2.	Set up and experimental design of the lab-scale system	31
3.3.	Analytical determination and analysis	34
3.4.	Evaluation of the behaviour of the anaerobic codigestion process	36
3.4.1.	Characterisation and determination of influent fractions	36
3.4.2.	Evaluation of cosubstrate mixtures in the AcD process	41
3.4.3.	Biogas production rates	42
3.4.4.	Stoichiometric and mass balance of the AcD process	43
3.4.5.	Kinetic evaluation of the hydrolysis/acidogenic processes	46
3.5.	Asses the performance of the secondary and tertiary treatment	47
3.5.1.	Nitrogen behaviour in the secondary and tertiary treatment	47
3.5.2.	Removal efficiency study in the wastewater treatment system	47
3.6.	Full-scale valorization system design	48
3.6.1.	Process flow diagram	48
3.6.2.	Preliminary design	49
3.6.3.	Layout	55
3.7.	Preliminary economical evaluation	55
3.7.1.	Balance sheet determination	56
3.7.2.	Profitability evaluation	57
<b>CHAPTER 4</b>		<b>58</b>
<b>Results and discussions</b>		<b>58</b>
4.1.	Evaluation of the behaviour of the AcD process	58
4.1.1.	Characterisation and determination of influent fractions.	58
4.1.2.	Evaluation of cosubstrate mixtures in the AcD process.	62
4.1.3.	Biogas production rates.	66
4.1.4.	Stoichiometric and mass balance of the AcD process.	67
4.1.5.	Kinetic evaluation of the hydrolysis/acidogenic processes	70
4.2.	Asses the performance of the secondary and tertiary treatment	72
4.2.1.	Nitrogen behaviour in the secondary and tertiary treatment.	72
4.2.2.	Removal efficiency study in the wastewater treatment system.	74
4.3.	Full-scale valorisation system design	77
4.3.1.	Process flow diagram.	77
4.3.2.	Preliminary design.	79
4.3.3.	Layout	80
4.4.	Preliminary economical evaluation	81
4.4.1.	Balance sheet determination	81
4.4.2.	Profitability evaluation	83
<b>CHAPTER 5</b>		<b>86</b>
<b>Conclusions</b>		<b>86</b>
<b>CHAPTER 6</b>		<b>87</b>
<b>References</b>		<b>87</b>
<b>CHAPTER 7</b>		<b>94</b>
<b>Appendices</b>		<b>94</b>

# List of Figures

<b>Figure 1.</b>	Evolution of the global GDP and the participation of the agricultural sector .....	1
<b>Figure 2.</b>	Farms distribution in Uruguay, according with the location and size of the establishments.....	2
<b>Figure 3.</b>	Drought effect in 2008-2009 farms profitability.....	3
<b>Figure 4.</b>	Pollution in the hydrological basins .....	4
<b>Figure 5.</b>	Land uses in the SLRB.....	5
<b>Figure 6.</b>	Interpretation of the anthropologic erosion in Uruguay at 2004 .....	6
<b>Figure 7.</b>	Problem tree about the pollution in the SLRB.....	8
<b>Figure 8.</b>	Incorporation of the valorization processes in the dairy production system.....	9
<b>Figure 9.</b>	Primary energy matrix in Uruguay and the incidence of the incorporation of RE .....	10
<b>Figure 10.</b>	Global P production curve .....	12
<b>Figure 11.</b>	Digesters installed in the world.....	13
<b>Figure 12.</b>	Concepts involved in the sustainable development.....	16
<b>Figure 13.</b>	Approaches to the environmental problems .....	17
<b>Figure 14.</b>	WSPs used for wastewater treatment from dairy farms .....	21
<b>Figure 15.</b>	Evaluation of AD technologies .....	22
<b>Figure 16.</b>	Anaerobic digestion of the organic matter .....	23
<b>Figure 17.</b>	Behaviour of glycerol uses .....	24
<b>Figure 18.</b>	Anammox and AOM processes in the biological reactors.....	26
<b>Figure 19.</b>	Lab-scale system diagram and sampling points .....	31
<b>Figure 20.</b>	Feeding regimen of the treatment system .....	33
<b>Figure 21.</b>	Influent COD fraction for the steady state anaerobic codigestion model.....	38
<b>Figure 22.</b>	Schematic diagram of the anaerobic digestion process .....	43
<b>Figure 23.</b>	Nutrients removal and water recycle in the designed valorization process. ....	49
<b>Figure 24.</b>	Primary treatment.....	50
<b>Figure 25.</b>	Anaerobic reactor system.....	51
<b>Figure 26.</b>	Scheme of the sludge drying process .....	52
<b>Figure 27.</b>	Scheme of the constructed wetlands and pond design .....	53
<b>Figure 28.</b>	Biogas line.....	54
<b>Figure 29.</b>	Initial topography evaluation of the ERB farm .....	55
<b>Figure 30.</b>	Anaerobic Biodegradability test results.....	60
<b>Figure 31.</b>	COD composition in the influent mixtures.....	61
<b>Figure 32.</b>	COD behaviour in the AcD process.....	63
<b>Figure 33.</b>	pH and acid/base effects in the AcD process .....	64
<b>Figure 34.</b>	Anaerobic fermentation of glycerol.....	65
<b>Figure 35.</b>	Biogas production rates determined in the AcD process.....	67
<b>Figure 36.</b>	Nitrogen behaviour in the EFF and GLY10+R conditions .....	72
<b>Figure 37.</b>	Chemical equations of the biological nitrogen processes.....	73
<b>Figure 38.</b>	Photos of biomass found in the bottom of the pond .....	74
<b>Figure 39.</b>	Removal efficiency of COD, TSS, TN and TP in the lab-scale system .....	75
<b>Figure 40.</b>	Removal efficiency of FC in the lab-scale system for the GLY10+R condition .....	76
<b>Figure 41.</b>	Zooplankton found in the pond .....	76
<b>Figure 42.</b>	Process flow diagram for the GLY10+R condition.....	78
<b>Figure 43.</b>	Scheme of the layout of the valorization system .....	81
<b>Figure 44.</b>	Investment costs details .....	82
<b>Figure 45.</b>	Incomes and costs variations in USD .....	84
<b>Figure 46.</b>	PP, IRR and NPV for different scenarios.....	85
<b>Figure 47.</b>	Batch anaerobic digestion process to the AB test.....	94

<b>Figure 48.</b> Lab-scale system installed.....	95
<b>Figure 49.</b> Pink growth inside of the settler .....	95
<b>Figure 50.</b> Scum formation in the reactor and settler.....	96
<b>Figure 51.</b> Samples for the last steady state condition (GLY10+R condition).....	96
<b>Figure 52.</b> COD behaviour and acid/base effects in the AcD process .....	105
<b>Figure 53.</b> Primary treatment design.....	106
<b>Figure 54.</b> Design of the anaerobic reactor .....	107
<b>Figure 55.</b> Design of the dewatering system .....	108
<b>Figure 56.</b> Design of the constructed wetlands .....	109
<b>Figure 57.</b> Top view of the pond design .....	110

# List of Tables

<b>Table 1.</b> Wastewater calculation characteristics study in the dairy farm.....	19
<b>Table 2.</b> Crude glycerol characterization in previous reports.....	20
<b>Table 3.</b> Biogas production rates reported.....	28
<b>Table 4.</b> Kits used in the analytical determinations by the Spectroquant® .....	34
<b>Table 5.</b> Parameters determined in the initial characterization .....	37
<b>Table 6.</b> Initial composition in the vessels of ABA test.....	39
<b>Table 7.</b> Fractions of elements in each component of COD <sub>Ti</sub> .....	40
<b>Table 8.</b> Parameters determined for the $f_{upi}$ and overall molecular formula of COD <sub>B</sub> .....	41
<b>Table 9.</b> Parameters determined for the evaluation of the cosubstrate mixtures .....	42
<b>Table 10.</b> Parameters determined for the biogas production rates calculations .....	42
<b>Table 11.</b> Parameters determined for the mass balances checks .....	45
<b>Table 12.</b> Steady state equations of AcD kinetics.....	46
<b>Table 13.</b> Parameters determined for the nitrogen evaluation .....	47
<b>Table 14.</b> Parameters determined for the removal efficiency evaluation .....	48
<b>Table 15.</b> Design parameters for the anaerobic reactor .....	51
<b>Table 16.</b> Initial characterisation of the substrates used in the AcD process.....	58
<b>Table 17.</b> VFA concentration determined by GC in the AB test.....	59
<b>Table 18.</b> Methane concentration determined by GC in the AB test.....	59
<b>Table 19.</b> Calculation of $f_{upi}$ from AB test.....	60
<b>Table 20.</b> CHONS analysis results .....	61
<b>Table 21.</b> Elements fraction calculations and overall molecular formula results .....	62
<b>Table 22.</b> VFA concentration determined by GC and their expression in COD.....	65
<b>Table 23.</b> Methane concentration in the biogas mixture.....	67
<b>Table 24.</b> Comparison of the experimental data with the theoretical analysis in the AcD process .....	70
<b>Table 25.</b> Comparison of the experimental data with the theoretical analysis of the kinetics .....	71
<b>Table 26.</b> Design parameters of the anaerobic reactor .....	80
<b>Table 27.</b> Incomes estimated for the full-scale system.....	82
<b>Table 28.</b> O&M costs estimated for the full-scale system.....	83
<b>Table 29.</b> Annual balances sheet in USD.....	83
<b>Table 30.</b> AB test results .....	102
<b>Table 31.</b> Lab-scale results .....	103
<b>Table 32.</b> Lab-scale results (cont.) .....	104

# Abbreviations

AAS	Atomic absorption spectrometry	ERB	Establecimiento Rincón Blanco
AB	Anaerobic biodegradability	FAO	Food and agricultural organization
ACP	Anaerobic contact process	FC	Faecal coliforms concentration
AcD	Anaerobic codigestion	$f_{AD}$	Fraction of anaerobic endogenous residues
AD	Anaerobic digestion	$f_C$	Carbon fraction
ADM1	Anaerobic digestion model N° 1	$f_{CV}$	COD content of VSS
Alk	Alkalinity	$f_H$	Hydrogen fraction
ALUR	Alcoholes del Uruguay	$f_N$	Nitrogen fraction
Anammox	Anaerobic ammonium oxidation	$f_O$	Oxygen fraction
AnRBC	Anaerobic rotating biological contact	$f_P$	Phosphorous fraction
AOM	Anaerobic oxidation of methane	$f_{upi}$	Unbiodegradable particulate fraction
ARU	Rural association of Uruguay	GC	Gas chromatography
AS	Activated Sludge	GDP	Gross domestic product
BCU	Central bank of Uruguay	GHG	Greenhouse gases
$b_{AD}$	Anaerobic digestion death rate	GLY	Crude glycerol at 70 %
BOD <sub>5</sub>	5-days biochemical oxygen demand	GLY5+R	EFF supplied with 5 % of GLY and recycle
CaO	Lime	GLY10+R	EFF supplied with 10 % of GLY and recycle
CC	Climate Change	Gly	Glycerol concentration
CFU	Colonies-forming units	GW	Groundwater
CHONS	Carbon, hydrogen, oxygen, nitrogen and sulphur	GWP	Global Warming Potential
CH <sub>4</sub>	Methane	$H^{cc}$	Henry's solubility defined as concentration
CI	Confidence interval	Helm	Helminth ova concentration
CM	Cow manure	HLR <sub>s</sub>	Surface hydraulic loading rate
CO <sub>2</sub>	Carbonic dioxide	HOLR <sub>s</sub>	Surface hydraulic organic loading rate
COD	Chemical oxygen demand	HRT	Hydraulic retention time
COD <sub>ACID</sub>	Acidified COD	H <sub>2</sub>	Hydrogen
COD <sub>B</sub>	Biodegradable COD	H <sub>2</sub> S	Sulphydic acid
COD <sub>BIOM</sub>	COD in the biomass	IDB	Inter-American development bank
COD <sub>s</sub>	Soluble COD	INE	National institute of statistics of Uruguay
COD <sub>T</sub>	Total COD	INIA	National institute of agricultural research of Uruguay
COD <sub>VFA</sub>	COD contended in the volatile fatty acids	IRR	Internal return rate
COD <sub>x</sub>	Particulate COD	IS	Inorganic solids concentration
CP	Cleaner production	ISS	Inorganic suspended solids concentration
CSTR	Continuous Stirred Tank Reactor	IWA	International water association
CV	Coefficient of variation	$K_H$	Hydrolysis constant of 1 <sup>ST</sup> order specific
CV1	Control volume 1	$K_s$	Half saturation concentration of Monod
D	Density	$K^+$	Potassium concentration
DFR	Dried feed residues	L	Unitary milk production yield
DIEA	Agriculture statistic department of Uruguay	LAGOON	Lagoon anaerobic reactors
DIG	Digestibility of the cow diet	LATU	Technological laboratory of Uruguay
DINAMA	Environmental agency of Uruguay	LCFA	Long chain fatty acids
DO	Dissolved oxygen	MBR	Membrane bioreactor
DTP	Danreé and Torres-Pardo architects	Met	Methanol concentration
E	Overall anaerobic biomass yield	MGAP	Agricultural ministry of Uruguay
EFF	Effluent produced by the dairy farm	MPN	Most probable number
EGSB	Expanded granular sludge bed	MVOTMA	Environmental ministry of Uruguay
EPDM	Etilen-propilen dien monomer	$Na^+$	Sodium concentration

NaOH	Sodium hydroxide	$t_d$	Death time in the milking process
N	Nitrogen	$t_{milk}$	Medium unitary times of milking process
n	Number of measures	$t_{feed}$	Medium unitary times of feeding process
$n_{mo}$	Number of milking organs	$t_{total}$	Daily time in the recollection area
nCRE	Non-conventional RE	TKN	Total Kjeldahl nitrogen
$NH_4^+$	Free and saline ammonium	TN	Total nitrogen concentration
$NO_2^-$	Nitrite concentration	TP	Total phosphorous concentration
$NO_3^-$	Nitrate concentration	TS	Total solids concentration
NPV	Net present value	$TS_{ing}$	Dry matter ingested by cow
$N_2O$	Nitrous oxide	TSS	Total suspend solids concentration
N+D	Nitrification-denitrification	UASB	Upflow Anaerobic Sludge Bed
OECD	Organization for eco. cooperation and development	UdelaR	University of the Republic of Uruguay
OLR	Organic loading rate	UNEP	United Nations Environmental Program
$OLR_v$	Volumetric organic loading rate	USD	United State dollar
$OLR_s$	Sludge organic loading rate	USDA	United State department of agriculture
Or	Number of milking process in a day	UTE	Electric company of Uruguay
O&M	Operational and maintenance	$V_T$	Reactor volume
$O_2$	Oxygen	VFA	Volatile fatty acids
P	Phosphorous	$VFA_{COMP}$	VFA composition
pH	Hydrogen ion concentration	VSS	Volatile suspended solids concentration
PF	Plug flow	VS	Volatile solids concentration
$PO_4^{3-}$	Phosphate concentration	$V_0$	Number of cows
PP	Payback period	WHO	World health organization
Q	Flow	WSP	Wastewater stabilization ponds
$Q_B$	Biogas flow	X	Averaged value
RE	Renewable energy	$X_i$	Unbiodegradable particulate COD
RBCOD	Readily biodegradable COD	$X_s$	Biodegradable particulate COD
$r_H$	Hydrolysis rate	$Y_{AD}$	Acidogen biomass yield
SD	Sustainable development	$Y_{MET}$	Methanogenic biomass yield
$S_i$	Unbiodegradable soluble COD	Z	Coefficient value for the t-test
SLRB	Santa Lucia river basin	$Z_{AD}$	Acidogen biomass concentration
$S_m$	COD in methane	$\alpha$	Recycle fraction of influent flow
SMA	Specific methanogenic activity	$\beta$	Efficiency separation in the settler
SRT	Sludge Retention Time	$\mu_m$	Maximum specific growth rate of Monod
$S_s$	Biodegradable soluble COD	$\%A_t$	Percentage of acidification
TC	Total coliforms concentration	$\%M_t$	Percentage of methanogenization
$TiO_2$	Titanium dioxide	$\%BD_t$	Percentage of the biodegradability
$t_i$	Time require of each batch in the milking process	$\Delta COD_B$	Biodegradable COD consumed

# CHAPTER 1

## Introduction

### 1.1. Problem statement

#### 1.1.1. Dairy farms in Uruguay

The dairy sector in Uruguay has been very important in the economical development of the country since its beginning. It constituted the 15 % of the agricultural Gross Domestic Product (GDP) in 2008 and the weight of the agricultural sector in the local economy was 6.2 % of the global GDP in 2015 (Acosta 2011, BCU 2015) (Figure 1).

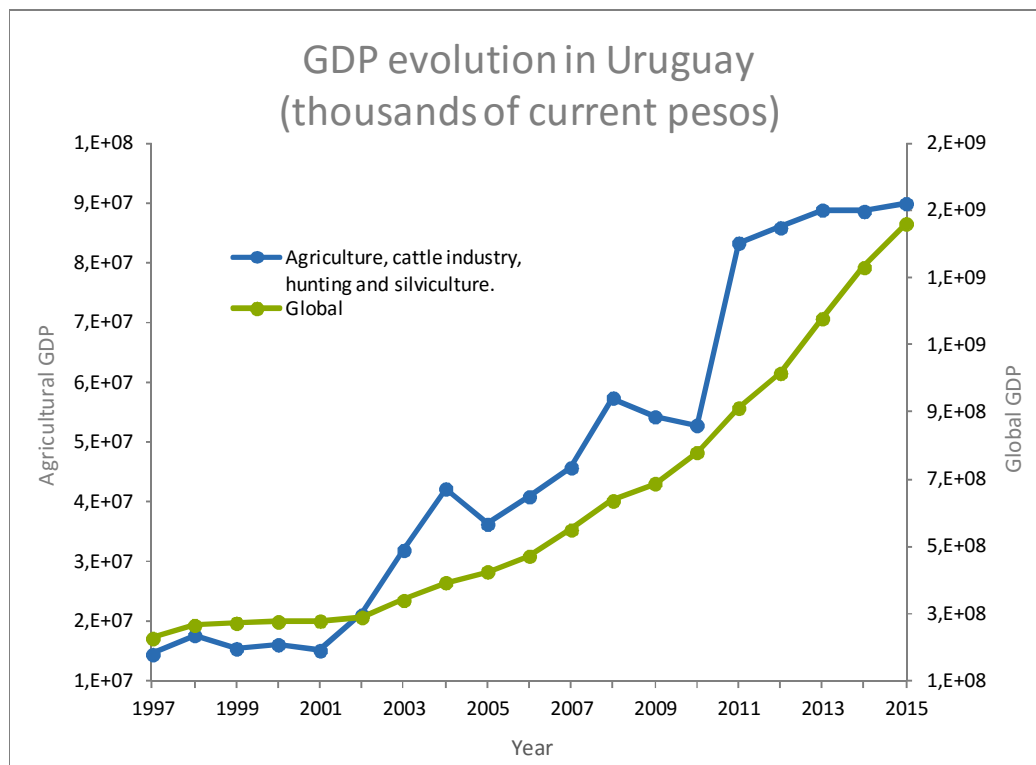
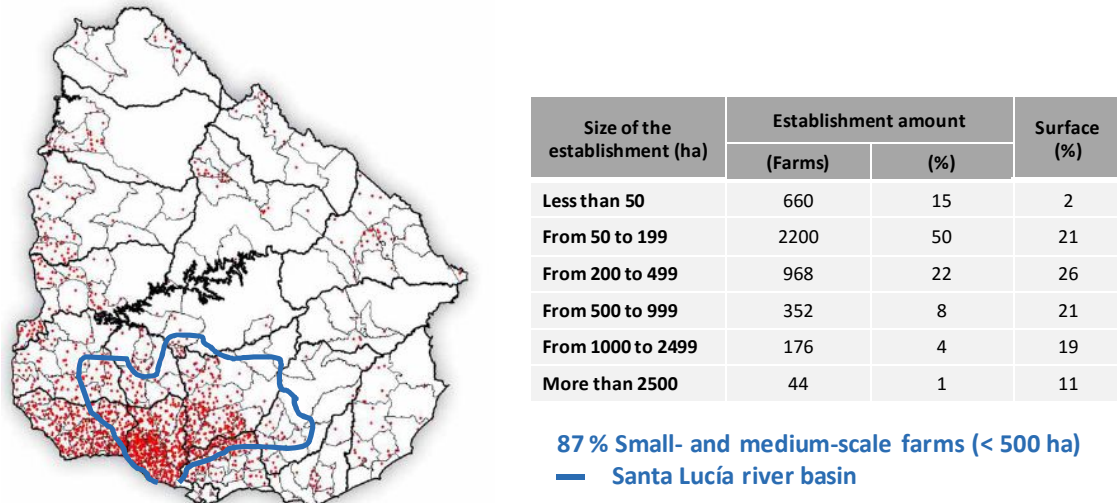

**Figure 1.** Evolution of the global GDP and the participation of the agricultural sector (BCU 2015).

In 2014 the dairy exports represented the 8.3 % of the total asset's sales of Uruguay (sales from tax free trade zones were included). After the markets of soya, beef and cereals, the dairy sector is the biggest export activity in the country (Uruguay-XXI 2015). According to the agricultural census of 2011, 14734 people work permanently in the breed and in the milking process of the milk cattle (DIEA-MGAP 2011). The 87 % of the 4,433 dairy establishments in



Uruguay in 2012, are small- and medium farmers (DIEA-MGAP 2012). This activity is fundamental in the economical development of people from the rural areas and helps to minimize the migration from countryside to cities, although this has not been completely avoided (González 22-04-2009, Aguirre and Varela 2010) (Figure 2).

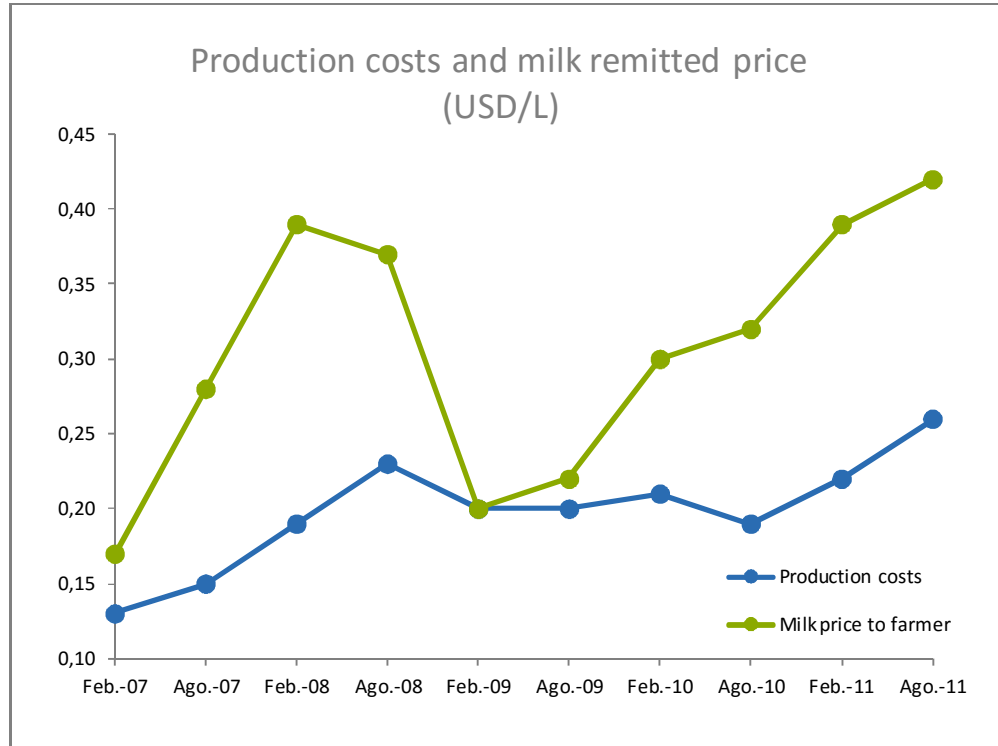

**Figure 2.** Farms distribution in Uruguay, according with the location and size of the establishments. Each red point in the map correspond with two farms (DIEA-MGAP 2012).

The majority of these establishments are in the Santa Lucia River Basin (SLRB). This river provides drinking water for the 60 % of the population in Uruguay and actually has a serious eutrophication problem (RAPAL Uruguay 2010, Achkar, Dominguez et al. 2012). For this reason, the Uruguayan authorities seek to regulate the activities to decrease the environmental impact from the agricultural sectors (Decreto 405/2008 2008, Decreto 182/2013 2013, Resolución Ministerial 159/2015 2015). In the current situation, the dairy farms and industries are contributing significantly to diffuse pollution in the agricultural basins (MVOTMA 2013). In summary, it is fundamental to act in the minimization of the impact of these activities in the environmental.

In the other hand, the dairy activity depends largely on the weather, principally because of flooding and droughts (Uruguay-XXI 2015). The impact of these on the profitability is very important, generating very large fluctuations in the profits. An example of this, is the variability in the price of the milk remitted to the processing factories after the drought of 2008 when the lost was estimated in USD 25: (ARU 2009, Uruguay-XXI 2012) (Figure 3) . Another drought with similar effects on the dairy sector occurred again in the autumn-winter in 2015 (Antunez 28-04-2015). This causes that the dairy sector cannot invest in improve their process in a long-term.

The complexity of the current situation of the sector has triggered the search of solutions that minimize the mentioned economic and environmental instabilities. In this context, the present work wants to develop low-cost technologies for the sustainable development of the farmers and their rural establishment.



**Figure 3.** Drought effect in 2008-2009 farms profitability. Average price to farmer and unitary production cost of the litre of milk in Uruguay (Uruguay-XXI 2012).

In summary, a previous sector analysis concluded the following characteristics of the farmers in Uruguay. The interviews with the farmers (alone or associated groups) were crucial to define the 'status quo' in the effluent treatment systems that are applied nowadays.

- The sector is composed mainly by small- and medium farmers that generally do not have information about the environmental impact of their activities and the possibility to get products with added value from the effluents.
- The farmers are reticent to apply new technologies in the establishment. The innovative activities are only applied for few farmers and the distribution of the technologies depends of the opinion leaders.
- The establishments are concentrated and facilitate the regional solutions for small-scale farms.
- Generally the farmers are organized in associations, allowing for better communication and the expansion of the emerging technologies.
- There is a low investment in the dairy sector, only triggered by the market needs. The large fluctuations in the profit do not allow to invest in long-terms solutions.
- Lack of information about financial aid tools for them adaptation to the Climate Change (CC) and from investment promoter laws.
- The small- and medium farms are not related yet to engineering companies and consultants. However, the effluent treatment processes of wastewater from dairy farms are known and contribute in an important base line.
- The amount of energy and nutrients produced by valorization process are adequated for their use in the establishment.

- Generally the profitability of the establishment depends only of the sale of a unique product (milk).
- Argentina and Brazil are the most important milk producers in America, the geographic distribution and the production systems become a way for expand the technology.

### 1.1.2. Natural resource pollution

In the last years, a preoccupant pollution of the natural resources has been evidenced, mainly in the characteristics of the surface water and the soil but also detected in the CC. The importance of the agricultural activities in the economy and the effects of these environmental changes on the production, increase the vulnerability of the country in the future.

#### Hydrologic resources

The state of the main hydrologic basins in Uruguay has been affected for the agricultural intensification, that produced an increment of the nutrient availability in the water bodies and the consequent eutrophication (Mazzeo 2002, RAPAL Uruguay 2010, Carrasco-Letelier, Beretta Blanco et al. 2014). The following figure show the pollution in the main river basins evidenced by the phosphorous concentration in the water bodies and by the journalists since 2013 (Blasina 05-04-2013, Blasina 14-06-2013, Aparicio 20-03-2013, Rojas 20-05-2014, Carrasco-Letelier, Beretta Blanco et al. 2014) (Figure 4).

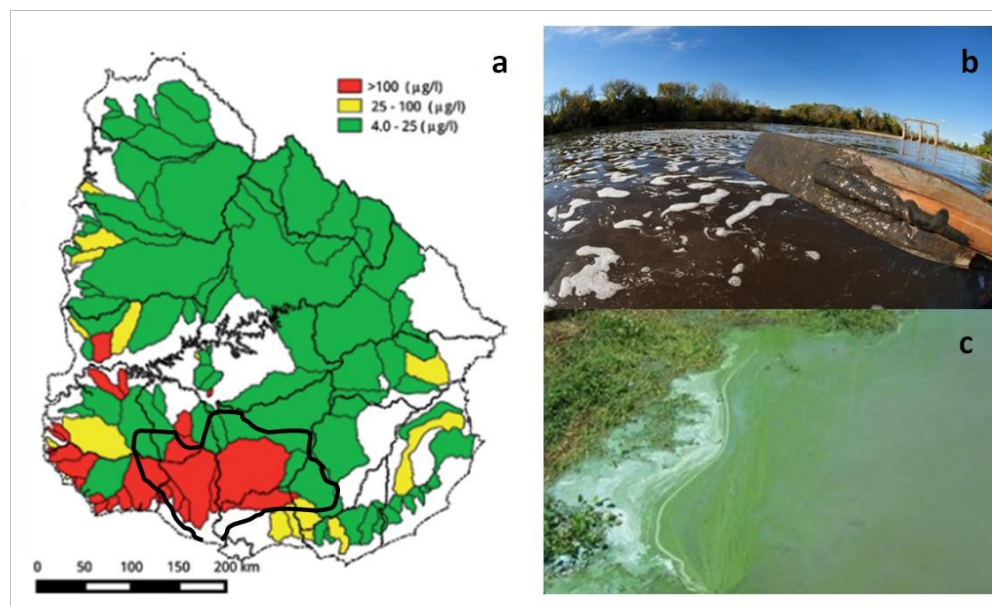

**Figure 4.** Pollution in the hydrological basins. a. Dissolved phosphorous in the water bodies, SLRB in black (Carrasco-Letelier, Beretta Blanco et al. 2014). b. Santa Lucia river polluted. c. Negro river eutrophized.

The eutrophication process consists in the bloom of the population of the microorganism produced by the increase of the availability of nutrients, mainly nitrogen (N) and phosphorous (P), in the water bodies (Mazzeo 2002). The high concentration of nutrients in the watercourses is due to the erosion of the soil, the excessive use of synthetic fertilizers and

pesticides, and the discharge of the improperly treated domestic, industrial and agricultural effluents in the water bodies (Mazzeo 2002, RAPAL Uruguay 2010).

Specifically, the SLRB is the source of drinking water for the 60 % of the population in Uruguay, principally the Paso Severino, Canelón Grande and Aguas Corrientes dams (RAPAL Uruguay 2010). Nowadays, the potabilization processes of the surface water have been difficult because it has a high presence of toxins, from algae bloom. These has affected the drinking water supply and the cost of the treatment has incremented in the last years (Aparicio 08-03-2015, Aparicio 20-03-2013, RAPAL Uruguay 2010).

The agricultural sector, specifically the intensive livestock activities (dairies, feedlots, pig-breeding and poultrys), has a strong impact on the pollution of the watercourses. It has been identified as the main source of diffuse pollution in the SLRB because of it is the most intensive production zone in Uruguay (RAPAL Uruguay 2010, Achkar, Dominguez et al. 2012) (Figure 5).

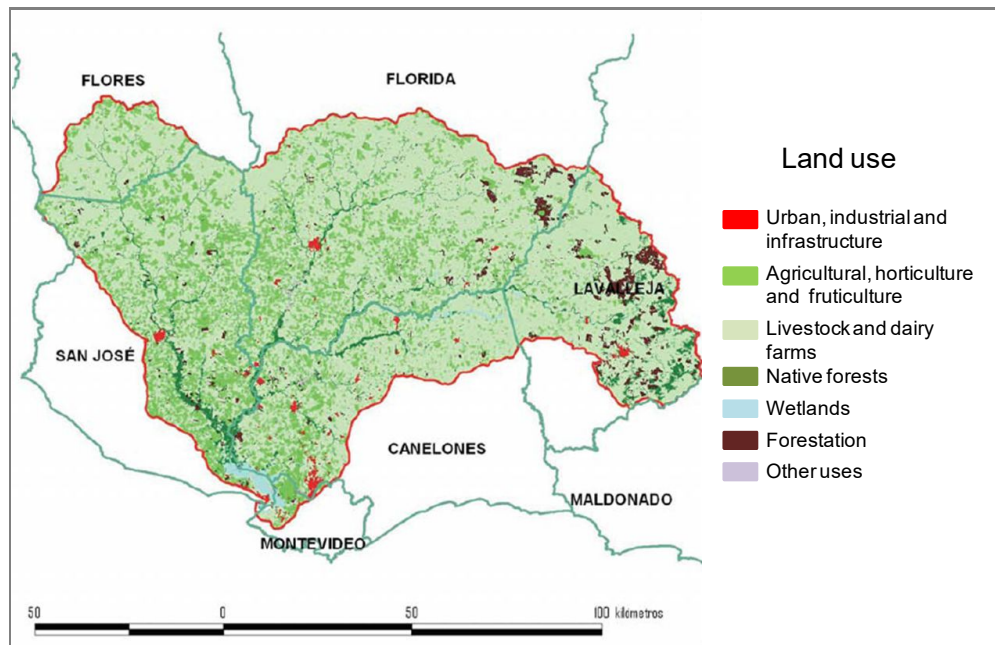

**Figure 5.** Land uses in the SLRB (Achkar, Dominguez et al. 2012).

## Greenhouse gases

Others environmental aspects to consider are the Greenhouse Gases (GHG), as carbonic dioxide ( $\text{CO}_2$ ), methane ( $\text{CH}_4$ ) and nitrous oxide ( $\text{N}_2\text{O}$ ). The intensive consumption of fossil fuels from the industrial revolution and the deforestation have caused a rise of these gases in the atmosphere (Karl and Trenberth 2003). The high concentration of GHG in the atmosphere and the low capacity of depuration have produced an imbalance in the carbon cycle and the consequent GHG effects. Uruguay is an important emitter of  $\text{CH}_4$ , because its production is highly related to the intense agricultural activity (organic material degradation and the ruminants breeding) (MVOTMA 2004).

For this reason, is important to decrease the emissions of these GHG to the atmosphere, with the aim of mitigating the rise in the global temperature that, direct or indirect, impact in the ecosystemic balance and in the production systems.

One strategy to minimize this impact is to catch the gases emissions and then to do the combustion of the CH<sub>4</sub> to CO<sub>2</sub>. The reason is that the first one has a Global Warning Potential (GWP) 25 times bigger than the second one. This combustion not only produces Renewable Energy (RE) but also decreases the contribution in the CC.

## Erosion

The development of the intensive agricultural activities requires generally of the nutrients reincorporation to the soil because these have been extract from the land in the production system applied. Actually, in the Uruguayan agricultural production context, the synthetic fertilizers are mostly used for this reincorporation with the only objective to increase the N, P and some micronutrients concentrations in the soils. However, in advanced production cycles the productive capacity of the land is modified. The reason is that the extraction of micronutrients and the losses of the physical structure of the soil are causes of the erosion process (Peralta-Alba 1990). In fact, in Uruguay the geographic distribution of the erosion process corresponds with the geographic distribution of the intensity in the agricultural production (Figure 6).

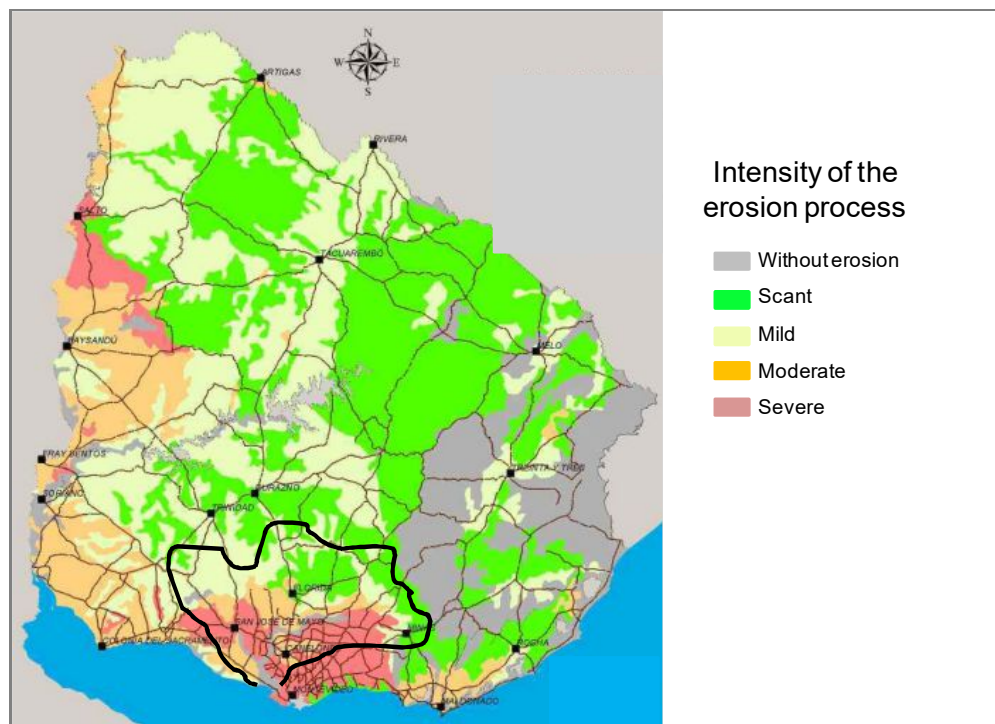

**Figure 6.** Interpretation of the anthropologic erosion in Uruguay at 2004. Extracted from the geographic information system of MGAP.

The anthropologic erosion is one of the most important environmental impacts nowadays in Uruguay. As a results of this, an innovative regulation has been developed in the proper use and handling of the soil in the all country (Decreto 405/2008 2008).



## 1.2. Justification and significance of the proposed project

This project was propelled for environmental, social and economic factors and was according to the actual Government policies in these issues. The main objective is to achieve a Sustainable Development (SD) for the mentioned production processes. This concept was developed in 1987 by G. H. Brundtland, where the SD was defined as the development that 'improves the life quality of the people, without compromise the future generations' (Brundtland 1987). The proposed way of solving the mentioned focus problem will contribute to trigger the SD of the small- and medium dairy farms in Uruguay.

### 1.2.1. Environmental impacts

According to previous explanations, the most important hydraulic basins in the country are polluted. However, the problem in the SLRB has become important due to the importance of this river as the source of drinking water for the main part of the population in Uruguay (Achkar, Dominguez et al. 2012). Based in a 'status quo' of this environmental system, a problem tree had been developed where the causes and the consequents of the mismanagement of the basins are identified (Figure 7). The focus of this project is to act in some causes involved in the pollution of the basin, so as to contribute in a global solution of the problem.

One of the most important effects of this pollution is the eutrophication of the surface water bodies (Mazzeo 2002), being the agricultural sector a principal responsible of the diffuse pollution in the basin (RAPAL Uruguay 2010). Since the dairy activities are concentrated in this zone of the country an especial interest in this activity branch is taken. Generally in these establishments does not exist an efficient effluent treatment systems and the discharges are directly done in the surface water bodies without secondary treatment. As a consequence, the concern of the local environmental agency (DINAMA) and the farmers was triggered in the last years (Filguiera 20-08-2013).

The droughts has had a strong influence in the profitability of the dairy farm activities (Antunez 28-04-2015). Being able to adapt to future droughts in order to minimize its economic impact on the productivity, is a priority for the farmers and the Government (Grimm 2011, MGAP(a) 2013, MGAP(b) 2013). In this context, the recycle of the pre-treated effluent in the daily cleaning activities of the dairy farm is essential to save a main fraction of the groundwater (GW) consumption. A low-cost wastewater treatment is needed to achieve the required standards for this recycling. The implementation of Cleaner Production (CP) actions would allow to decrease the water consumption for the daily activities, which would reduce the production cost and saving water for irrigation in the case of future droughts.

Other important impact to the environment is the erosion of the productive soils (Silva 09-01-2013). One of the most important causes is the extraction of the soil components and the inefficient reincorporation of them (Peralta-Alba 1990). The synthetic fertilization does not integrate the organic matter and micronutrients required to keep the physical structure and the productivity of the land. The application of organic fertilizer, as a stabilized sludge produced in the valorization process, will allow the recycle of nutrients in the establishment and it will avoid the residues discharge in the water bodies. Macronutrients, micronutrients and organic matter (as humic acids) could be reincorporated to the soil after of a proper treatment and conditioning. As a result of this, not only a decrement of the erosion process can be detected but also the fertilization costs would be lower and be more sustainable.

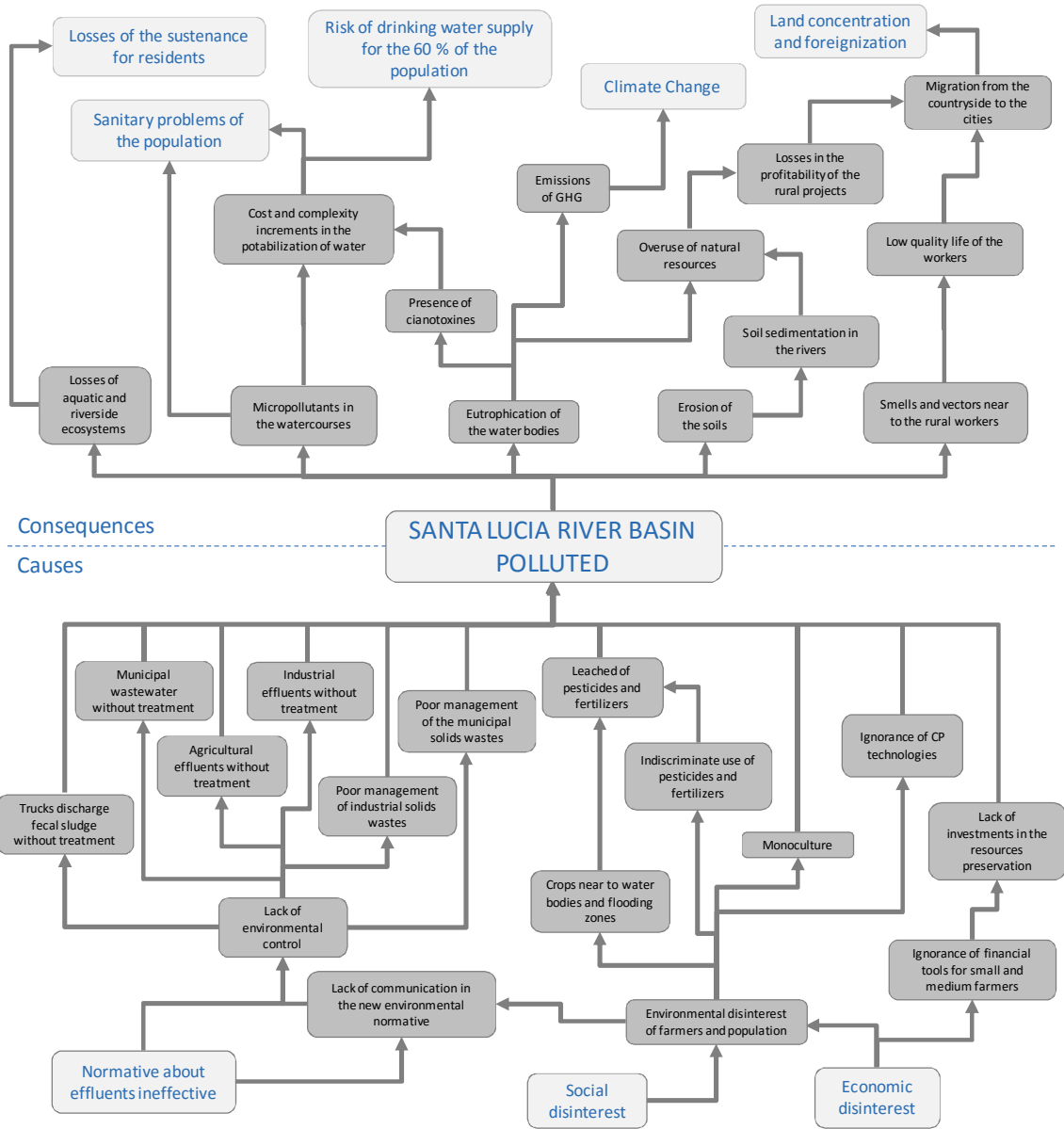
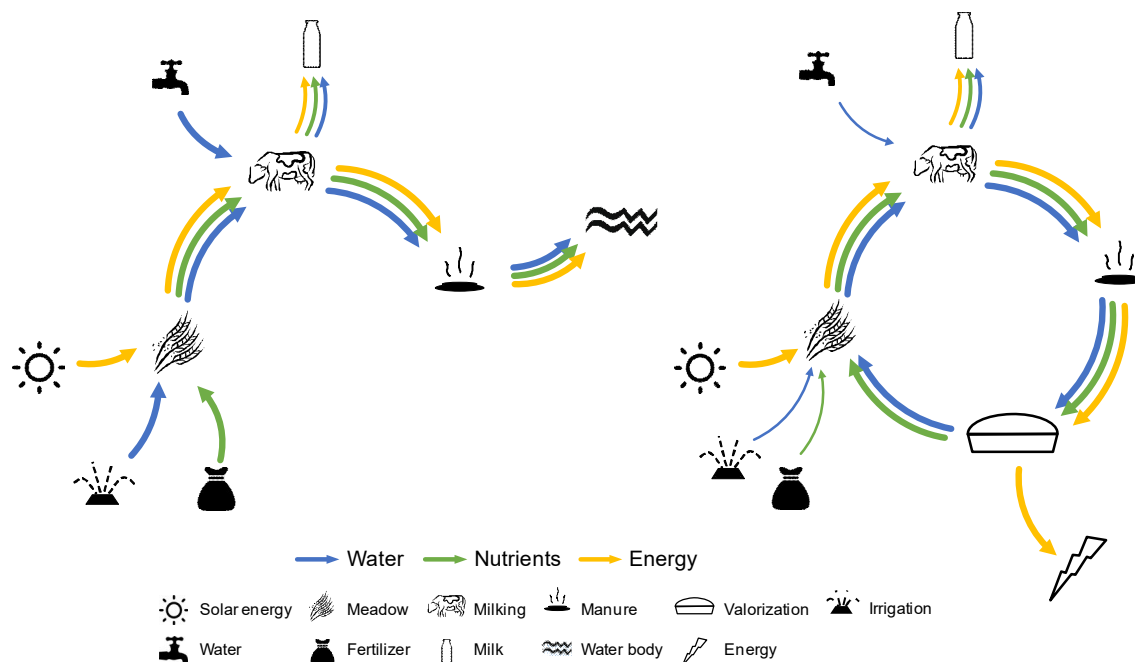

Figure 7. Problem tree about the pollution in the SLRB.

In addition, the emission of GHG to the atmosphere has increased the impact to the environment (MVOTMA 2004). While Uruguay does not have high industrial activity that contributes to the GHG effect, the livestock and the organic matter degradation in uncontrolled conditions produce a big amount of CH<sub>4</sub>. This gas has an important effect in the Global Warming and the consequent CC (Tinker, Ingram et al. 1996, Karl and Trenberth 2003). The accumulation of this gas in the treatment process and the subsequent combustion produce RE and the effect in the environment can be decreased by its conversion to CO<sub>2</sub> (Lashof and Ahuja 1990).

### 1.2.2. Water, energy and nutrient recycles

The impact of the current dairy production system in the environment has been triggered by a lineal production model (Figure 8). This approach does not consider the recycle of the resources and products with potential value are discharged to the ecosystems. The harmful effects into the environment of this model have direct impacts in the habitats and in the profitability of the farms.



**Figure 8.** Incorporation of the valorization processes in the dairy production system. Left: current production system, lineal approach. Right: wastewater valorization in the proposed system, recycle approach.

The inclusion of CP actions and techniques in the production system, as the water and nutrients recycling and RE production in the treatment process, allow to minimize the environmental impact of the activities. This innovative approach, based in the economy recycling, tries to avoid the effluent discharges of the production system, using these resources as income to generate products with added value.

### Water

The effects of the CC in Uruguay have generated unbalances in the pluvial regimens. For instance, it is evidenced the increment in the frequency and intensity of the drought and flooding events. Even in 2015 both weather phenomena have affected the country. This change in the pluvial regimens affects the profitability of the farms, being the dairy establishment the most affected due to its environmental dependency. Following measures for the CC adaptation, the local Government and international institutions (as World Bank and Inter-American Development Bank, IDB) have developed financial and knowledge tools for minimize the environmental impacts of the agricultural activities (MGAP, MVOTMA et al. 2012, MGAP(a) 2013, MGAP(b) 2013).



According to the Water Footprint Network, the global water consumption to produce 1 Litre of milk in the market is 900 Litres (Mekonnen and Hoekstra 2012). For this reason, achieving a reduction in the water consumption of the dairy chain, even small changes, will produce a big impact in the global scale. The recycling of the treated wastewater in the own farm is the strategy to achieve it. The water economized in the clean activities, will be available for irrigation purposes in the farm. This action would reduce the direct dependency of the weather factors in the availability of water for the main activities.

## Energy

The increment in the energy costs in the farms and its importance in the profitability propels the idea of energy production from the combustion of biogas generated during the organic matter degradation. This type of energy is considered as RE because it comes from renewable material as animal or vegetable biomass.

Given the strong energy dependence that had Uruguay in the fossil fuels and the impacts of them in the environmental and the CC, the Uruguayan Government has triggered the diversification of the energy matrix. The incorporation of clean and local energy instead of fossil fuels were the ways chosen for this diversification (DNE-MIEM 2008, Méndez 2013). As a result of these actions, Uruguay was in 2015 the first country to achieve the 50 % of RE in the primary energy matrix (Méndez 2013, Uruguay-XXI 2013, IDB 2014) (Figure 9) .

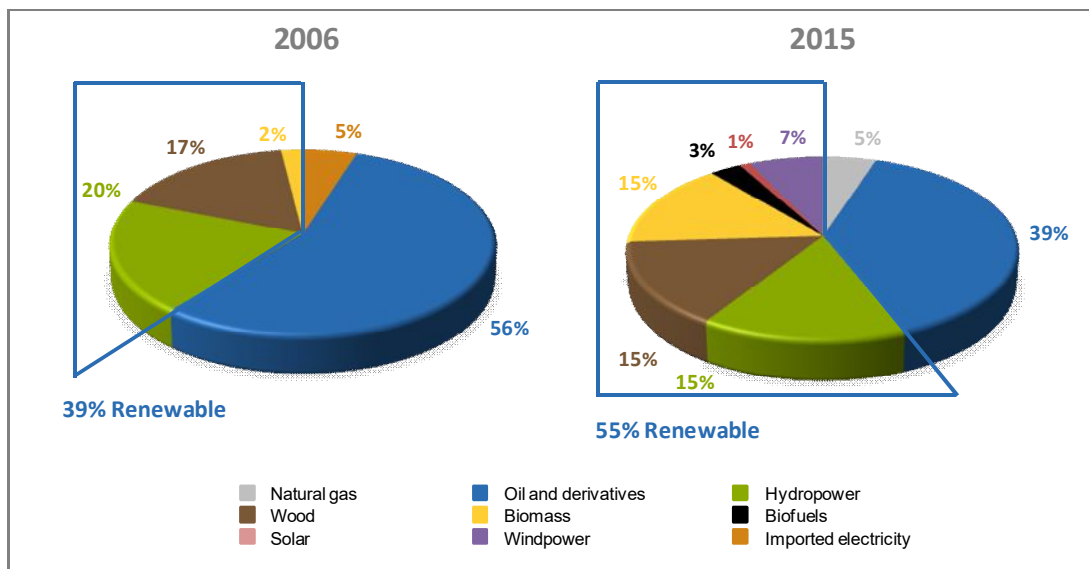

**Figure 9.** Primary energy matrix in Uruguay and the incidence of the incorporation of RE (Méndez 2013).

The possibility to sale energy from any householder or establishment to the public energy company, 'Usinas Termoeléctricas del Estado' (UTE), was a tool developed to commercialize the excess of the local energy produced. The Decree 173/2010 about energy microgeneration set the standards for this energy exchange and it forces to UTE buy this exceeding energy (Decreto 173/2010 2010). As a consequence, the generation of energy in a small-scale has been triggered principally when the energy come from renewable sources. In this context, the non-Conventional Renewable Energies (nCRE) have taken greater importance. The production of nCRE does not compete with the food consumption (as biodiesel from energy crops) in the raw material that they use. In this way, the energy

production that uses waste as starting material takes more impulse and importance. Consequently, the development of a system to manage the produced wastes in the agricultural activities and to generate added value from them, results of high importance. The Anaerobic codigestion (AcD) process is an important tool to achieve it; the production of the biogas generated in this natural process and the commercialization of the energy produced, are the key in the valorization processes planned.

The biogas combustion, not only decrease the impact in the environment but also would be a parallel business line for the dairy farms, improving the stability of the small- and medium-scale establishments.

## Nutrients

One of the main objectives of the planned valorization system is the reincorporation of the nutrients extracted from the soil; mainly P, micronutrients and organic matter. The organic fertilization of the land using the stabilized sludge and the treated effluent from the valorization process are the chosen way for doing it. These actions search to minimize the impact of the dairy activity and its implementation are required in the most critical zone of the country (MGAP 2015, Resolución Ministerial 159/2015 2015).

In the scheme proposed a total balance of the nutrients in the establishment is designed, the valorization system release only carbon (C) and N to the gas phase in the environment (as  $\text{CO}_2$  and  $\text{N}_2$ ). However, the P and some micronutrients are presented in the main product of this activity (milk). The capacity of the ecosystems for the C and N fixation are widely known and distributed (Calvin cycle and the biological nitrogen fixation respectively), being the problematic limited to the reincorporation of P and micronutrients.

The unique global source of P is the mining, where a maximum peak of its extraction is estimated by 2033 (de Ridder, de Jong et al. 2012) (Figure 10).

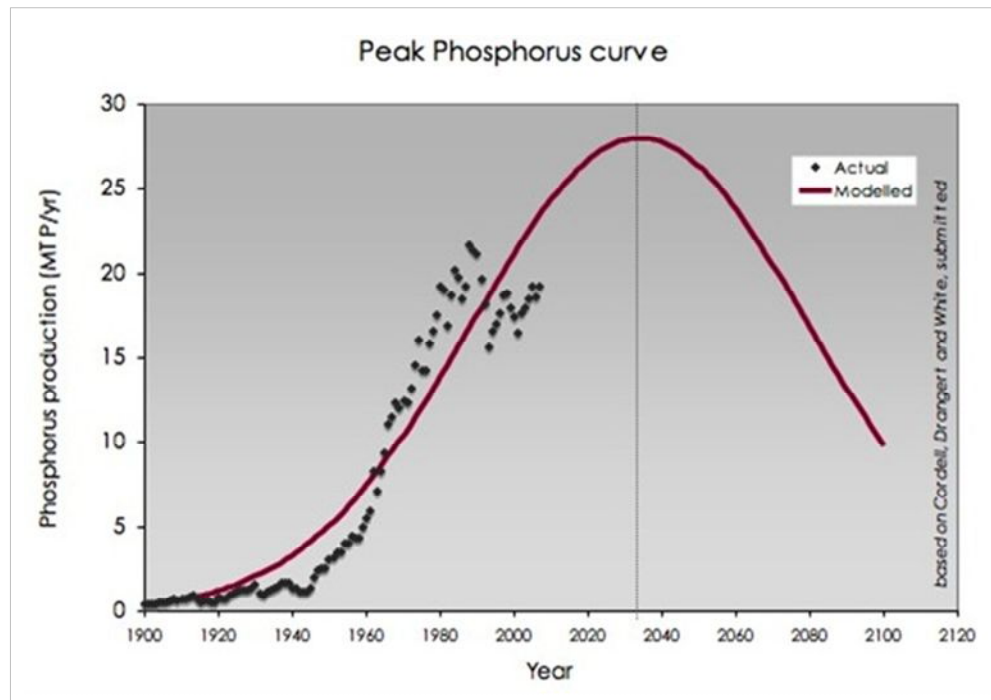

**Figure 10.** Global P production curve. Model based in productivity data until 2009 (de Ridder, de Jong et al. 2012).

As a consequence, there will be a rise in costs of synthetic P-based fertilizer and its recycling in the production systems will take more relevance. As was mentioned, in the current situation the P is incorporated to the land as synthetic fertilizer and it is further discharged in the water bodies as an effluent or in the run-off, producing the eutrophication of the hydraulic basins.

### **1.2.3. Community**

The distribution of the population in Uruguay had major changes in the last decades. The most preoccupant aspect is the migration of the farmers from the countryside to the cities (González 22-04-2009, Aguirre and Varela 2010). According to the census in 2011, only the 5.3 % of the population lives in rural areas (INE 2013). Therefore, it is an important problem considering that agriculture is the main economic activity of the country. This data also shows the foreignization of the productive lands and the endeavour of the Government in this area is to facilitate the distribution of the countryside to the familiar farmers to work in it (Gutierrez 02-03-2012, Gutierrez 05-12-2014, Berteche 06-08-2014).

A suitable management of the wastes in the farms has a positive effect in the processes and in the living style of the rural workers. As an important side product, the surroundings of the establishment will be clean, without smell and flies that affect the hygiene and the quality of life in the property. The valorization system projected allows catching the effluents and confines it in a closed system avoiding the propagation of disease vectors.

The implementation of CP strategies and techniques in the farms improve the quality of life of the workers and users. Also the new knowledge available in the productive processes of the establishment can generate a greater connection of the people with the productive sector (mainly women and young people). Also the social groups could be strengthened due to the joint development of the new activities and technologies and the natural resources protection by the region.

### **1.2.4. Low-cost technologies**

This project search to develop a system that allows valuing the effluent produced in the dairy farms through the application of low-cost technologies available for small- and medium farmers.

The intensification of the agricultural productivity in Uruguay has generated an increase in the effluent production. The inefficient treatment has polluted the watercourses because of residues discharges that do not achieve the quality standards. According with the sector characteristics, these wastewaters are generally concentrated with a high content of biodegradable suspended solids. The treatment of these type of effluents is feasible using anaerobic processes (Rajeshwari, Balakrishnan et al. 2000, Sakar, Yetilmezsoy et al. 2009, Traversi, Bonetta et al. 2013). The application of AcD technologies not only allows to reduce the Chemical Oxygen Demand (COD) but also produces biogas and stabilized sludge as main products. This type of process has the advantage that does not require energy for the organic matter degradation, as the case of aerobic processes. In contrast, the AcD can recover a part of the chemistry energy existing in the effluent.

The versatility and the scale that can be applied, turns the AcD as a proper solution to treat the cow manure (CM) produced in the farms. A big amount of digesters have been installed in the world. The increment in the number of installation in the last years is huge according to described by Burns in 2009 (Burns 2009). For instance, until 2009 China had set up 37: of basic technologies digesters, while more than 8500 high technologies digesters were installed in Germany by 2014 (Figure 11). Principally, it has been developed two types of technologies of AcD processes and basically the differences between them are the investment and Operational and Maintenance (O&M) costs, the removal efficiency and the scale that are installed. As expected, the high technology systems are commonly distributed in developed countries, allowing high removal efficiency with a small footprint and the consequent increment in the costs. In developing countries, generally low-cost technologies are incorporated using local supplies. Thought the removal efficiencies are lower than the high-tech system, the investment and O&M cost are cheaper. This type of technologies is applicable in householders and small- and medium-scale farms.

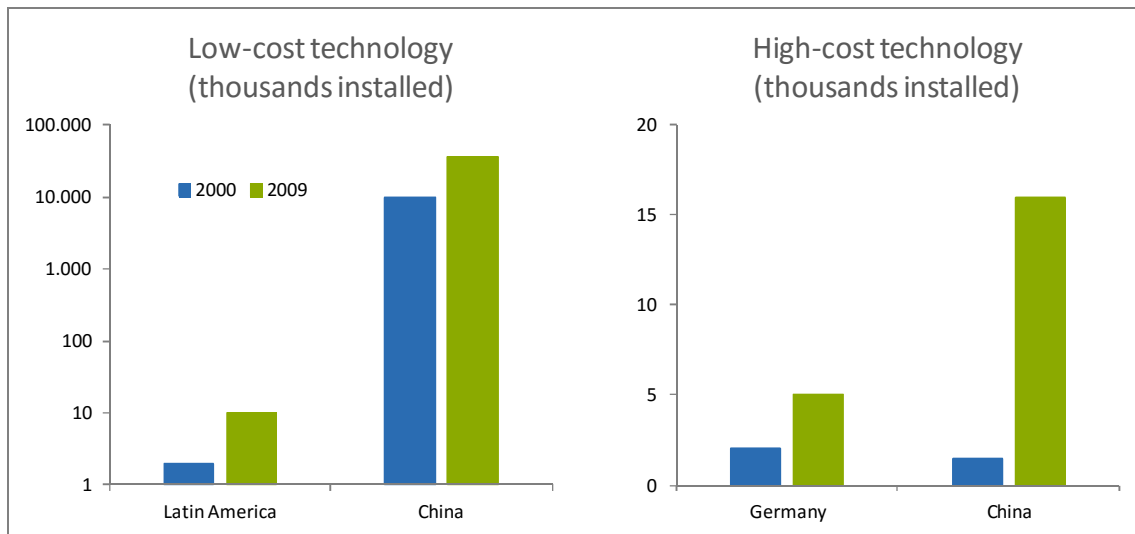

**Figure 11.** Digesters installed in the world. Extracted from Burns et. al. (Burns 2009).

The current situation of the agroindustrial sector in Uruguay is an intermediate position between the countries that apply low-cost technologies and the countries that incorporate high-cost technologies. This is because the country has high agricultural intensification, the water bodies are polluted and the supplies and energy are expensive. These characteristics of the economical sector produce the increment of operative cost of agricultural activities. For this reason, the development of an anaerobic reactor adapted to the local conditions is needed. The AcD system to be developed must have the following characteristics that ensure the correct implementation in the production system in the local farms:

- Low O&M costs. Without compromising the economic feasibility.
- Easy to operate and to maintain. External agitation and heating are desired to reduce the move parts inside of the reactor.
- Low footprint required. Plug flow reactor and the recycling of the biomass allow to increase the efficiency in the biological process by the high biomass content inside the reactor.

- Integration of different process in one reactor. The integration of biochemistry process, biomass sedimentation and gasholder in one reactor reduce the investment costs and the footprint.

Additionally, the biogas production can be enhanced with the incorporation of others wastes available in the local market as cosubstrates. This increases the biodegradability of the wastes and the productivity of the system because it dilutes the toxics compounds and complements the nutrients for the biological processes. However, the AcD processes cannot remove significantly pathogens, N and P. For these reason, tertiary treatment must be incorporated to achieve the quality for the reuse or the discharge of the effluent.

In summary, the application of a group of low-cost processes as a valorization system allows the recovery of energy, water and nutrients in the farm.

### **1.2.5. Potential applicability and feasibility**

The potential applicability of the AcD process in the valorization system planned must be determined by the understanding of the biological process. The modelling of the lab-scale digester will allow to predict the behaviour in a full-scale system and finally the feasibility of the technology in different production systems. The preliminary design and the economical evaluation will allow to estimate the operative parameters, defined by the lab-scale experiments, of the valorization system for a dairy medium-farm in Uruguay. The system to be designed considers a dairy farm with 180 milking cows located in Kiyú (ERB), estate of San José, Uruguay. The development of the lab-scale experiments will consider the production system applied in this farm.

#### **Feasibility**

The mains economical aspects of the project are based in the sale of the electricity produced to the low voltage network of UTE, the saving of the water consumption and the recycle of the nutrients in the farms. The incomes are related to the added value products to be obtained in the wastewater treatment, that in the current situation are an environmental passive.

Recycling of the treated effluent for the clean activities is an important pillar in the feasibility of the proposed systems. The savings of GW consumption allow to have water available for others activities as the irrigation of the meadow. Previous calculations show that the savings could be around the 70 % of the water consumption. The reason is that this water saved could be used to clean purposes of the dirty zone in the dairy farm. However, is very complicated to estimate the economic value of this saving since in Uruguay the farmers do not pay for the extraction of water from natural resources, so for this reason the profit is subjective. Finally, other factor that adds profit to the project is the reduction of synthetic fertilization in the establishment. The application of the stabilized sludge and the irrigation of the treated effluent in the land, aims to decrease the external needs for the fertilization purposes. The organic fertilization is more effective and sustainable than the conventional systems. Furthermore, the nutrients recycle in the farms aims to reduce the discharge into the surfaces water bodies to prevent the eutrophication problems (Mazzeo 2002, RAPAL Uruguay 2010).

The incorporation of these type of technologies brings direct fiscal benefits to the farmers according to the new normative (Decreto 02/2012 2012). In the Decree 02/2012, the Government generates tax free rates for the investments that promote the generation of jobs,

the population decentralization in the country, the increment in the commercial exports, and all activities that aim to decrease the environmental impact of industry. All these factors determine the percentage in the taxes exoneration that the company will access. The characteristics of this type of projects predict a big reduction in the taxes adding an extra income to the valorization systems, although it did not consider in this opportunity.

In contrast to the previous explanation, others intangible factors as the social and environmental aspects, triggers the development of this type of technologies. It is important to remark that in Uruguay the waste generators do not pay for the pollution produced, decreasing the economical profitability of any treatment process. Some intangible benefits are presented below.

#### Environmental aspects

- Recuperation of the deteriorated soils by the organic fertilization.
- Saving of GW for drought events.
- Reduction of the emission of GHG.

#### Social aspects

- Reduction of the presence of smell, flies and vectors.
- Implementation of a solid wastes management system.
- Inclusion of the local farmers in the development of new technologies.

## 1.3. Research question and objectives

### 1.3.1. General objective

This research aims at developing a technological low-cost wastewater treatment solution for small- and medium-scale dairy farms. The AcD of the farm effluent and by-products from biodiesel production are using in the operation of the lab-scale system, along with secondary and tertiary wastewater treatment to use the effluent of the system as water source. A preliminary design of a full-scale system and an economical evaluation were carried out.

### 1.3.2. Specific objectives

- I. Evaluate the behaviour and the kinetic of the lab-scale anaerobic digester considering the codigestion and the water recycle processes.
- II. Asses the performance of the secondary and tertiary treatment as tools to save water consumption in the farm.
- III. Based on the inputs obtained from the lab-scale system results, design a full-scale dairy farm waste valorisation system.
- IV. Determine a preliminary financial evaluation of the technology implementation in a full-scale production system.

## CHAPTER 2

# Background

### 2.1. Sustainable development and cleaner production

In the last decades the society together has been involved in a change of paradigm about the environmental and the natural resources care, since the SD was expanded since 1992 (Brundtland 1987). The object is to incorporate and to integrate efficiently the social, economical and cultural development with the environmental care (Figure 12). Uruguay is also included, for example a law about land use and SD has been implemented (Ley 18308/08 2008). Additionally, the local Ministry of Agricultural (MGAP) has developed the incorporation of a management plan in dairy farms to achieve the SD in the sector (Resolución Ministerial 159/2015, 2015).

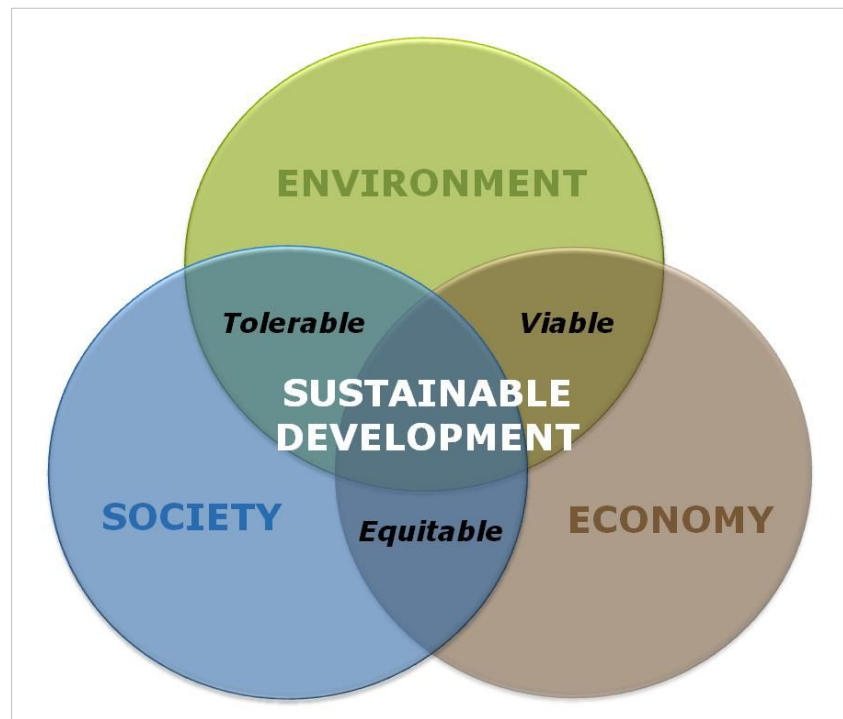
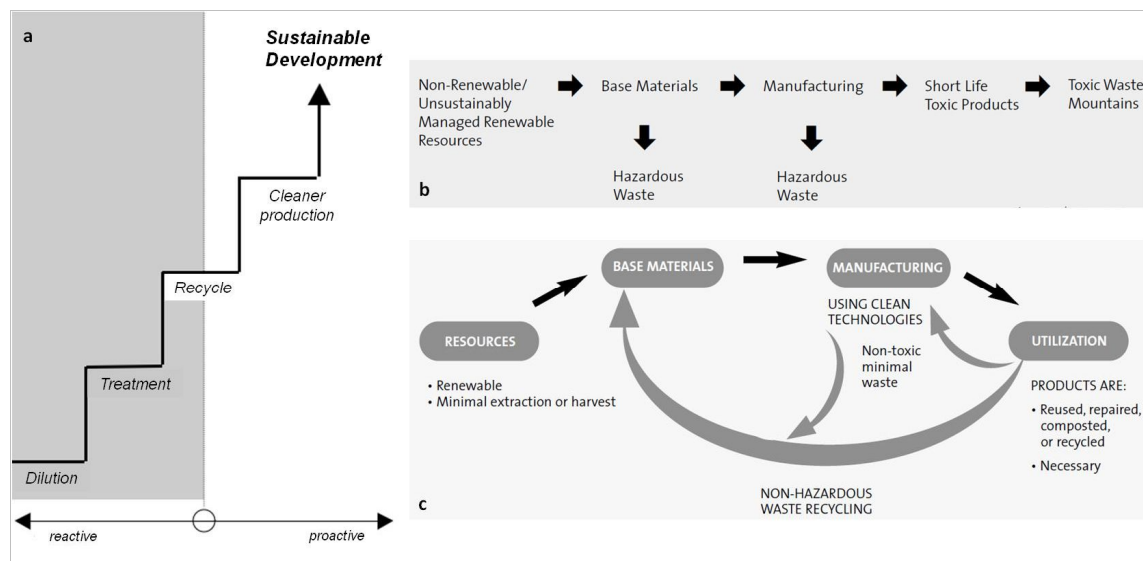

**Figure 12.** Concepts involved in the sustainable development.

The concept of SD can be easily adapted in the agricultural local sector by the implementation of different technologies and measures to get CP systems. The economy development of the farms (viable), the improvement in the quality life of the workers and rural

habitants (equitable), and the reduction of the impact in the environmental (tolerable) can be triggered by the incorporation of the CP.

The environmental market has been developed based in the environmental wear and not in the prevention measures. Around of 70 % of the environmental technologies are 'end of pipes solutions', when the pollution was produced. Franceso di Castri emphasised in 1997, 'the countries only designate 7 % of the environmental budget in prevention and the other 93 % in correcting treatments' (Bustos 04-04-1997). However, in the last years the tendency to the CP has been evidenced. The United Nations Environmental Program (UNEP) define the CP as 'a continue application of technologies, based in the preventive environmental strategy and integrated with the process, products and services to increase the eco-efficiency and to reduce the environmental risks for the human being' (UNEP 2009). These have the focus on the decline of emissions from the beginning of the production process, reduce the consumption of supplies and energy and increase the energetic efficiency. According to a report about the state of environmental from Organization for Economy Cooperation and Development (OECD) in the 90's, 'to produce clean only rise the costs between 2 % and 5 %, while the remediation can increase the production costs between 10 % and 15 %' (OECD 2008). As a consequence, a change in the paradigm has been triggered, where the conventional lineal approach in the processes is exchanged for systems based in the recycle of the economy (Thorpe 1999) (Figure 13).



**Figure 13.** Approaches to the environmental problems (UNEP 2009). a. Current paradigm in the production systems. b. Conventional approach, lineal. c. Modern approach, based in economy recycle (Thorpe 1999).

Consequently, the farmers can take two different positions in front of the pollution considering the economic factors, the legislation and the pollution: a) the remediation, referred to the installation of equipment that control or eliminate the pollute agents while extreme treatment; or b) the prevention, intervention of the processes using clean technologies to do not produce the pollution, and including internal treatment process (Aldy, Hrubovcak et al. 1998, Seoánez 1998).

Advantages of the application of CP technologies are the improvement the results, the implemented measures are permanent, reliable, effective, profitable and generally increase



the productivity. Some of these CP measures are the recycle, substitution, recovery and valorization. For example, some activities for achieve it are the diversification, the nutrients recycle, the biological nitrogen fixing, the use of local sources of RE, the separation of the vegetal biomass, the high yield crops, the multipurpose trees, the use and control of wastewaters, the integrated management of plants pests and disease, the rotation and association of crops and the minimum ram work (Corchete 1986, Escobar, Messa et al. 1998, Nieto, Murillo et al. 2002).

In this context, the Food and Agricultural Organization (FAO) has recommended the implementation of CP technologies, principally the AcD based systems, as a fundamental tool in Latin America to achieve the SD. This is because it is an agricultural region with high breeding activities and a subsequent production of organic solid wastes; and the limited geographic distribution of energetic services (FAO 2014). In contrast to be a treatment system with a high cost for the farmers, the implementation of a valorization system could develop a secondary business line by the electricity sailing. Additionally, the water and nutrients recycle and the energy recover allow dropping the cost in the production systems. However, the feasibility of these strategies and technologies depends of the social, economical and environmental conditions in the farms. As a consequence, the global situation of dairy sector in Uruguay must be studied in detail for the application of CP technologies (Reijntjes, Haverkort et al. 1992).

## 2.2. Wastewater characterisation

### 2.2.1. Dairy farm residues

The first approach to the valorization system is the characterization of the effluent to be treated. In this project, the CM and dried feed residues (DFR) production rates, the GW consumption and the stormwater production in the pavement area are considered in the combined wastewater treatment process to be studied and designed. The CM production depends of the time of the milking and feeding process (Viñas and Gutiérrez 2004), while the stormwater production depends of the rainfall events (INIA-GRAS 2011).

In the Uruguayan dairy production systems the cows are in the countryside the most part of the day. The daily time in the recollection area ( $t_{total}$ ) is the sum of the medium unitary time of milking process ( $t_{milk}$ ) and the time in the feeding area ( $t_{feed}$ ), and both determine the amount of CM and DFR produced in the establishment. The  $t_{milk}$  depends of the number of cows ( $V_0$ ), the number of milking process in a day ( $Or$ ), the number of milking organs ( $n_{mo}$ ), the time required by each batch ( $t_i$ ) and the initial death time ( $t_d$ ) (Equation 1) (Viñas and Gutiérrez 2004).

$$(1) \quad t_{milk} = \left[ \frac{n t_i \sum(V_0/n)}{60 V_0} + \frac{t_d}{60} \right] Or = \left[ \frac{t_i (V_0 + n)}{2 n 60} + \frac{t_d}{60} \right] Or$$

The mixture between the CM, DFR and GW used for cleaning activities are fixed by the production system and is called EFF to simplify. In this case the 86 % of the TS in the EFF are from the CM slurry and 14 % of the TS are from the DFR. The EFF quality depends mostly of the diet of the cows, the GW consumption and the time in the recollection areas (Viñas and Gutiérrez 2004). The dry matter ingested ( $TS_{ing}$ ) by the milking cows is 26 KgTS/ $V_0.d$  with a diet digestibility of 65 % (Dig) and an average of 18 L/  $V_0.d$  of milk. As a

consequence, in the recollection area the amount of solid matter available to be treated will be 740.5 KgTS/d considering 6,2 h/d as  $t_{total}$  for 250 cows (Equation 2).

$$(2) \quad TS_i = TS_{ing} \text{ Dig } (t_{milk} + t_{feed})$$

In the ERB farm the daily GW consumption for clean purposes of 180 cows are 9.2 m<sup>3</sup>/Or by 2 milking processes in a day, 16 m<sup>3</sup>/d by a feeding process and 1.8 m<sup>3</sup>/d in the auto cleaning process of the milk's tank. As a consequence, the daily average wastewater production for this farm is the 62.6 m<sup>3</sup>/d, considering 250 of milking cows in the farm for the coming years, the 3.2 m<sup>3</sup>/d of stormwater and a recovery factor of 90 %.

Based in the wastewater production in the cleaning process, previous studies in the concentration and distribution of nutrients in the manure and urine (Viñas and Gutiérrez 2004), and the pathogens contents (Foxon, Pillay et al. 2004, Mentz, Wiest et al. 2004, Viñas and Gutiérrez 2004), the following table shows a preliminary wastewater composition produced by the studied dairy farm (Table 1).

**Table 1.** Wastewater calculation characteristics study in the dairy farm based in Viñas et. Al. and Mentz et. al. (Mentz, Wiest et al. 2004, Viñas and Gutiérrez 2004).

Parameter	Symbol	Concentration
Flow	Q <sub>i</sub>	59.6 m <sup>3</sup> /d
Total solids	TS	13.6 KgTS/ m <sup>3</sup>
Volatile solids	VS	8.5 KgVS/ m <sup>3</sup>
Total suspended solids	TSS	10.9 KgTSS/ m <sup>3</sup>
Volatile suspended solids	VSS	7.0 KgVSS/ m <sup>3</sup>
Total chemical oxygen demand	COD <sub>T</sub>	11.7 KgCOD/ m <sup>3</sup>
Biological oxygen demand	BOD <sub>5</sub>	3.8 KgCOD/ m <sup>3</sup>
Free and saline ammonium	NH <sub>4</sub> <sup>+</sup>	0.40 KgN/ m <sup>3</sup>
Nitrate	NO <sub>3</sub> <sup>-</sup>	0.005 KgN/ m <sup>3</sup>
Nitrite	NO <sub>2</sub> <sup>-</sup>	0.001 KgN/ m <sup>3</sup>
Total Kjeldahl nitrogen	TKN	0.42 KgN/ m <sup>3</sup>
Phosphate	PO <sub>4</sub> <sup>3-</sup>	0.02 KgP/ m <sup>3</sup>
Total phosphorous	TP	0.05 KgP/ m <sup>3</sup>
Total coliforms	TC	8.4 x 10 <sup>8</sup> CFU/100mL
Helminth ova	Helm	7.27 Helm/L

This information is only an approach in the EFF characteristics, the complete characterisation of the wastewater must be determined in this system to get the proper data for modelling purposes.

### 2.2.2. Biodiesel by-products

The crude glycerol as biodiesel by-product (GLY) has been used in the last years as a cosubstrate in the AD process with different wastes (Astals, Nolla-Ardèvol et al. 2012, Castrillón, Fernández-Nava et al. 2013, Castrillón, Marañón et al. 2013, Timmerman, Schuman et al. 2015). Some of these works did a proper characterization of the GLY used and the results are showed in the following table (Table 2).

**Table 2.** Crude glycerol characterization in previous reports (Castrillón, Fernández-Nava et al. 2013, Timmerman, Schuman et al. 2015).

Parameter	Symbol	Concentration		Units
		Castrillon 2013	Timmerman 2015	
Hydrogen ion concentration	pH	7.6	8.1	-
Total solids	TS	997	886	gTS/Kg
Volatile solids	VS	949	842	gVS/Kg
Total chemical oxygen demand	COD <sub>T</sub>	837	1185	gCOD/Kg
Methanol	Met	5.6	-	% (w/w)
Glycerol	Gly	49.6	-	% (w/w)
Sodium	Na <sup>+</sup>	16.8	-	g/Kg
Volatile fatty acids	VFA	-	40.5	gCOD/Kg
Density	D	-	1351	g/L

The characteristics of this residue depend drastically of the biodiesel production process and it must be determined for the waste that will be used. However, the pH and the methanol content are the most crucial aspects to consider for the AcD purposes because the toxic compounds could be affect the biogas productivity. Additionally, the sodium (or potassium) concentration could be have an impact in the soil by the fertilization using the stabilized sludge and the treated effluent.

## 2.3. Technology selection

### 2.3.1. Industrial effluent treatment technologies

The wastewater from dairy farm are generally treated using physicochemical and biological process (Traversi, Bonetta et al. 2013). However, the biological processes are usually chosen because the COD removal in the physicochemical methods is limited by high operational costs. Within the biological processes, Wastewater Stabilization Ponds (WSP), Activated Sludge (AS), and anaerobic treatment are commonly used for wastewater treatment from dairy farms (Traversi, Bonetta et al. 2013).

In Uruguay, the most distributed system for this purposes consist in the typical WSPs (anaerobic, facultative and maturation ponds) (Viñas and Gutiérrez 2004). In contrast, this treatment process does not achieve high removal efficiency because generally it has a poor O&M (Figure 14). Additionally, the GHG emissions, the presence of vectors and smell in the establishment are not improved. The WSPs do not allow the water and nutrients recycle efficiently in the production system. Actually, obsoletes 'end of pipe' technologies are applied involving high investment and O&M costs. In summary, the replacement of the technology is needed if the aim is avoid the pollution (discharges in water courses and atmospheric emissions).



**Figure 14.** WSPs used for wastewater treatment from dairy farms. Pictures taken in a conference about dairy farm effluent treatment in 2014. Left: anaerobic silted pond. Right: Discharge of the treated effluent in a water body.

Other alternatives for the treatment are the aerobic processes. Although these are effective in the nutrients removal, they require the external supply of air. The high O&M costs produce that the aerobic processes are impossible to apply in small- and medium-scale farms. Additionally, the conventional AS process require a big footprint because it needs diluted solution inside the reactor and large settler to separate the biomass and the effluent. The size of the aerobic systems has been reduced by the Membrane Bioreactor (MBR) technology because the reaction solution is concentrated. In this case, an additional increment in the cost must be incorporated because the ultrafiltration membranes are required (expensive and generally clogged by this type of particulate effluent). Moreover, the rise in the energy cost is generated because require pumps for hydraulic movement and vacuum.

As a result of the previous explanation, the anaerobic processes take importance to treat this type of concentrated effluents because a high oxygen ( $O_2$ ) transfer is not required (Rajeshwari, Balakrishnan et al. 2000, Sakar, Yetilmezsoy et al. 2009). Additionally, the AD allows getting energy from the treatment process, although the N and P removal is not appropriated. However, this technology can be used coupled with other secondary and tertiary treatment processes to achieve the discharge standards (Decreto 253/1979 1979, Liu, Zhao et al. 2015).

Continuous Stirred Tank Reactor (CSTR) and Anaerobic Contact Process (ACP) had been distributed in the beginning of the technology development (Tauseef, Abbasi et al. 2013). These were substituted quickly by high-rate anaerobic reactors due to the firsts require a big footprint (high Hydraulic Retention Times, HRT) and because they have mobile parts inside, involving high O&M costs (mixers mainly). The most distributed high-rate anaerobic reactor is the Upflow Anaerobic Sludge Bed (UASB) reactors and the subsequent Expanded Granular Sludge Bed (EGSB) (Figure 15). Though these reactors have high COD removal and high production of biogas accordingly, do not have mobile parts inside and have a low footprint; generally they require a soluble material to be treated. Given the presence of a big amount of fibres and particulate material in the wastewater, the implementation of these technologies in the farms is inadequate (require previous steps to clean the effluent).

The high-rate anaerobic reactors generally are composed by communities of microorganisms added in a support or in granules as UASB reactors. However, these types of systems are not used to COD removal when the influent is particulate because the incorporation of big materials into the reactor produce their collapse. The ACP reactors allow using a big amount of biomass inside the reactor, by the sludge recycle process, as the UASB. The

disadvantage of the ACP is that generally the biogas is released in the atmosphere in the sedimentation process of the biomass. As a consequence, the incorporation of the sedimentation zone inside the reactor are planned to catch this biogas and to avoid the air pollution.

The optimum hydraulic behaviour in the reactor is the Plug Flow (PF) conditions. This is because; the degradation of the organic matter follows a 1<sup>st</sup> order kinetic process. This operation regimen reduces the footprint required and decreases the reaction times. This is a substantial difference with other reactors that work with a completely mixed regimen as UASB or CSTR.

In conclusion, the local development of a high rate AD reactor coupled with low-cost secondary and tertiary treatments is needed to achieve more adapted systems for wastewater treatment of local dairy farms. The planned system is not the most efficient available to treat the effluents but it is more adapted to the social, economical, technological and environmental conditions of the small- and medium-scale farms in Uruguay.

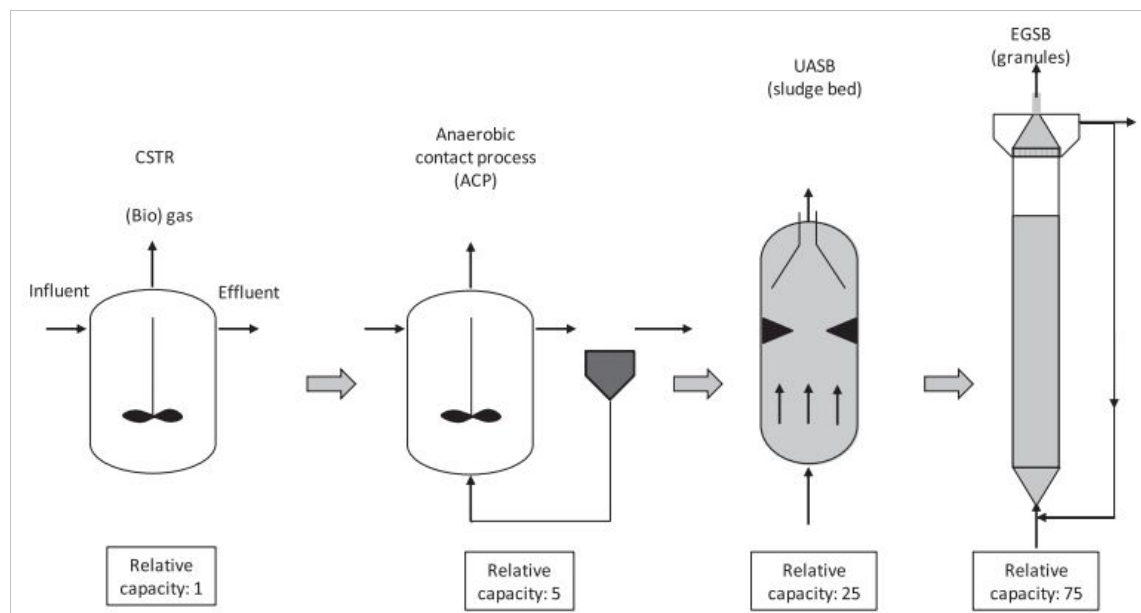
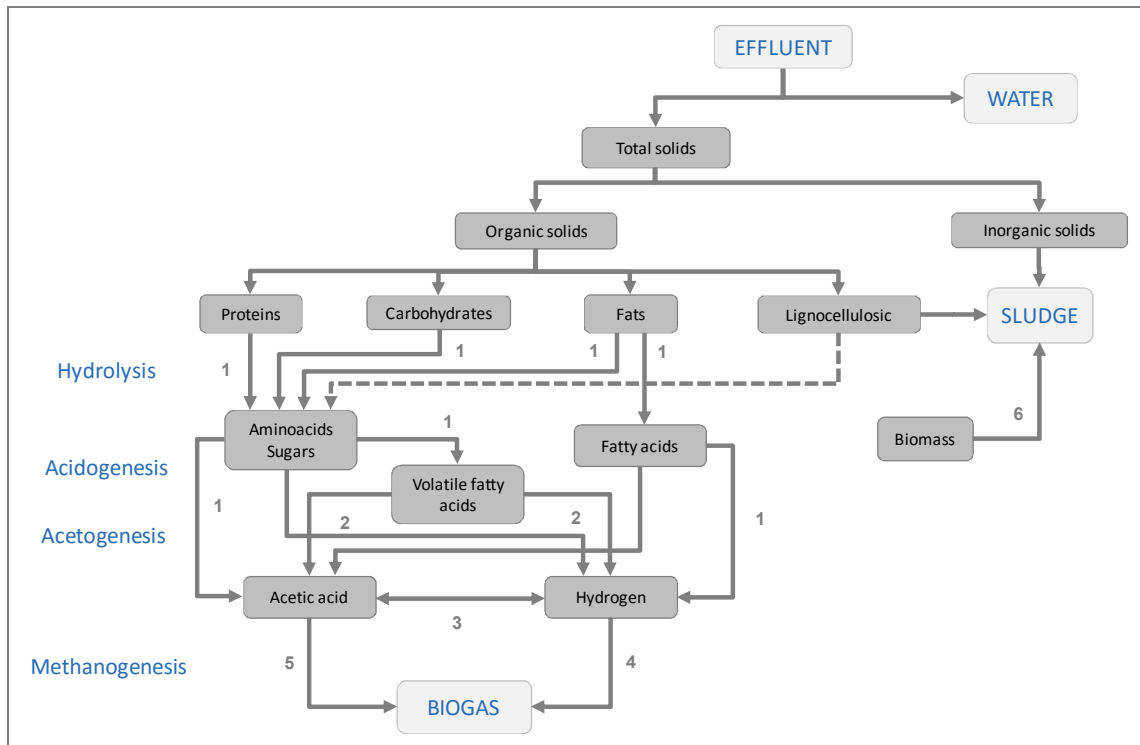

**Figure 15.** Evaluation of AD technologies. Developing process from the first generation reactors (CSTR y ACP) to the second and third generation (UASB y EGSB) (Tauseef, Abbasi et al. 2013).

### 2.3.2. Anaerobic digestion

The AD is a natural process that corresponds with the anaerobic carbon cycle by a coordinated action of different types of microorganisms (bacteria, archaeas, protozoa and fungi) in absence of O<sub>2</sub>. These can degrade the organic matter for feeding and reproduction activities, like every living being in the ecosystems. The cooperation between them is important so that the food for one type of microorganism is produced as a consequence of the metabolisms of another microbial consortium. When the organic matter (composed by natural polymers as polysaccharides, proteins and fats) is in an aquatic environment, the aerobic microorganisms act quickly. As a consequence, the dissolved O<sub>2</sub> is consumed generating anaerobic condition and triggering the microorganisms with these metabolisms.

The anaerobic consortium also consumes the organic matter available for feeding and reproduction purposes. Consequently, the respiration characteristics of the methanogenic archaeas produce a mix of gases composed by CH<sub>4</sub>, CO<sub>2</sub> and traces of N<sub>2</sub>, hydrogen (H<sub>2</sub>) and sulfhydic acid (H<sub>2</sub>S), called biogas. The unbiodegradable fraction of the effluent, that was not used as food, and the biomass of the microorganisms generated in the biological activity produce an stabilized anaerobic sludge composed by macro and micronutrients (Figure 16).



**Figure 16.** Anaerobic digestion of the organic matter. 1. Hydrolytic acidogenic microorganisms. 2. Acetogenic microorganisms. 3. Homoacetogenic microorganisms. 4. Methanogenic hydrogenotrophic microorganisms. 5. Methanogenic acetoclastic microorganisms. 6. Biomass generated in the anabolic processes.

The biogas generated as a consequence of these anaerobic processes (generally 60 % of CH<sub>4</sub> and 40 % of CO<sub>2</sub>, depending of the substrate and reaction conditions) can be used as energy resource by the exothermic combustion of CH<sub>4</sub> to CO<sub>2</sub>. Additionally, the stabilized sludge and the treated effluent are usually used as a fertilizer when the quality standards allow it. In summary, the biogas, the stabilized sludge and the treated effluent produced in the treatment processes have added value and should be used with productive purposes.

### Codigestion with biodiesel residues

The AD of agricultural wastes, manure specifically, does not have a big economical interest until this moment because it presents difficulties in the profitability of the full-scale projects. This is because it has low yields in the biogas production, and requires pre-treatment of the wastewater and the heating of the reactors (Cavinato, Fatone et al. 2010). However, a new situation has been developed with the codigestion technologies where different residues are mixed as a strategy to decrease the toxicity of the effluents or to improve the biogas

production yields (Mata-Alvarez, Dosta et al. 2014). The GLY is one of the main cosubstrates for the AcD of CM that has emerged because produces an increment in the rapidly biodegradable COD in the effluent to be treated biologically (Amon, Amon et al. 2006, Robra, Serpa da Cruz et al. 2010, Astals, Nolla-Ardèvol et al. 2012, Castrillón, Fernández-Nava et al. 2013, Timmerman, Schuman et al. 2015).

The GLY is the main by-product in the biodiesel production (10 % of the biodiesel produced), with the subsequent problem in its utilization or treatment (Ma and Hanna 1999). The search of solutions for its valorization has triggered a significant increment in the number of the scientific specialized publications in these areas (Figure 17). Additionally, the drop in the price of GLY in the global market has been evidenced in the last years (Clomburg and Gonzalez 2013). The biodiesel production in Uruguay and its incorporation in the gasoline dictated by the Law 18,195 also has been triggered (Ley 18195/07 2007, Texo, Bentancur et al. 2009). As a result of this, it is interest to incorporate this product in the valorization system as a cosubstrate.

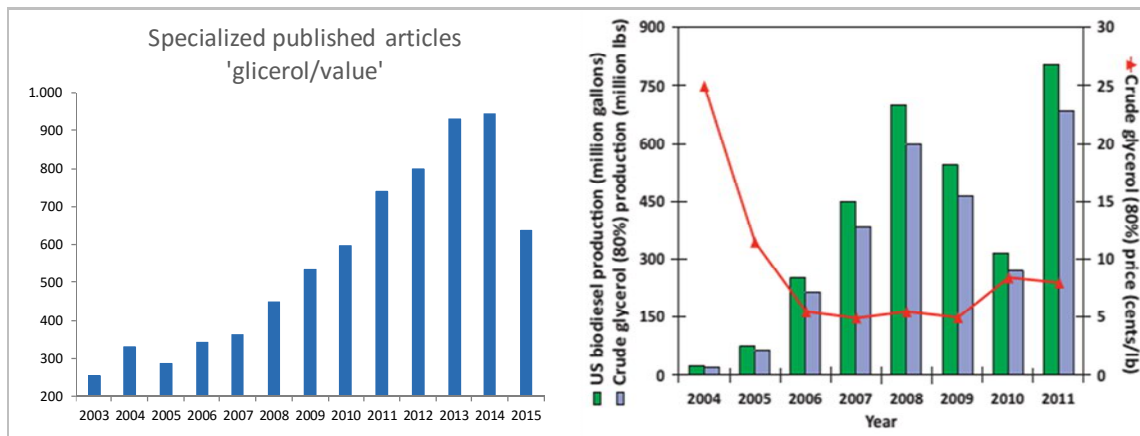

**Figure 17.** Behaviour of glycerol uses. Left: annual published articles based in a searcher SCOPUS in a total of 7,200 articles between 2003 and 2015, 'glycerol/value', 26-09-2015. Right: glycerol global market at 2011 (Clomburg and Gonzalez 2013).

The AcD of biodiesel residues (GLY) with CM has been tested in the last years and the previous results are promising. The potential biogas production of these mixtures will be presented in the following sections.

## Modelling

Mathematical modelling of the AD process was motivated by the need for efficient operation of anaerobic systems in the early 70's (Donoso-Bravo, Mailier et al. 2011). The scientific models on AD have been developing for almost 40 years. Some use the kinetics of the growth of microorganisms to predict the behaviour of the system, whereas others depend purely on the chemical reactions that take place. Due to the complexity of the process, each model is developed for a different purpose. As a result, there is currently a variety of models that vary according to the purpose that they were designed for. Among them, are comparatively simple models developed exclusively for calculating the maximum biogas rate, which will theoretically be produced during digestion. Others calculate the biogas rate taking into consideration degradation or digestion rates of different components of the biomass. Due to the limitation of many models to present the dynamic nature of the digestion, complex models have been developed to include the kinetics of the growth of microorganisms. The

activity of microorganisms and consequently the biogas production rate can thus be investigated for a variety of substrates rates of death rate and washout of microorganisms via different mechanisms.

The Anaerobic Digestion Model N°1 (ADM1) are the most used model, developed by the International Water Association (IWA) in the later 90's (Batstone, Keller et al. 2002). ADM1 includes multiple steps describing biochemical as well as physicochemical processes. The biochemical steps include disintegration from homogeneous particulates to carbohydrates, proteins and fats; extracellular hydrolysis of these particulate substrates to sugars, aminoacids, and long chain fatty acids (LCFA), respectively; acidogenesis from sugars and amino acids to VFA and H<sub>2</sub>; acetogenesis of LCFA and VFAs to acetate; and separate methanogenesis steps from acetate and H<sub>2</sub>/CO<sub>2</sub>. The physicochemical equations describe ion association and dissociation, and gas-liquid transfer. Implemented as a differential and algebraic equation set, there are 26 dynamic state concentration variables, and 8 implicit algebraic variables per reactor vessel or element. Implemented as differential equations only, there are 32 dynamic concentration state variables. All extra-cellular biochemical reactions are assumed to follow empirically based 1<sup>st</sup> order rate law kinetics, and all intra-cellular ADM1 reactions are assumed to follow the Monod type substrate uptake kinetics. The ADM1 model has been widely applied and validated in simulating the AD of several organic wastes (Shin and Song 1995, Keymer and Schilcher 2003, Blumensaat and Keller 2005).

Even though complex models like ADM1 are well suited for process simulation, they are substantially limited for process control and optimization application. Moreover, in large-scales digesters, it is difficult to encounter ideal mixing, and the actual complex flow behaviour is very different to constant-volume, completely-mixed system assumed by ADM1. However, the complexity of ADM1 leads to the need for many input parameters, ultimately resulting in a large number of stoichiometric and kinetic equations, for which parameter identification and manipulation can prove difficult.

In order to simplify the study of the behaviour of the AcD process, a model based in the works of Ekama *et.al.* for sewage sludge is developed (Sötemann, Ristow et al. 2005). The steady state model comprises three sequential parts: a. a kinetic part from which the COD removal and methane production are determined for a given Sludge Retention Time (SRT); b. a stoichiometry part from which the gas composition (or partial pressure of CO<sub>2</sub>), ammonia released and alkalinity (Alk) generated are calculated from the COD removal efficiency; c. a carbonate system weak acid/base chemistry part from which the digester pH is calculated from the partial pressure of CO<sub>2</sub> and the Alk generated.

### 2.3.3. Nitrogen removal

The recycle of the effluent in the production system is an important issue to consider in the application of CP technologies in the establishments. Economics benefits can be achieved by the water saving because the external dependency of water for drought events decrease or it can be used in aquaculture (Martins, Eding et al. 2010). Though the pathogens presence in the effluent is crucial to achieve the water recycle, the AcD process inhibition by a high content of ammonium (NH<sub>4</sub><sup>+</sup>) and unbiodegradable COD is determinant (Chen, Ortiz et al. 2014, Wang, Lu et al. 2014). In raining season, the treated effluent cannot be applied in the land as a liquid fertilizer, although the water quality is reached, so the water must be recycled to avoid its discharge in the watercourses. The determination of the number of cycles, or the concentration of NH<sub>4</sub><sup>+</sup> or unbiodegradable COD, before the inhibition takes place is primordial for the AcD process. As a consequence, the maximum recycle period to avoid the biogas production drops can be determined.



A widely strategy to decrease the  $\text{NH}_4^+$  concentration in the treatment systems is the nitrification-denitrification (N+D) processes. In this case, constructed wetlands are chosen as low-cost technology (Fisher and Acreman 2004, Saeed and Sun 2012, Liu, Zhao et al. 2015).

The initial objective is to convert the  $\text{NH}_4^+$ , composing the digester effluent, to  $\text{NO}_3^-$  by nitrification process. The operation of one of the wetland designed by semi-continuous feeding regimen (punctual discharges), will allows the incorporation of air required for this process (Tanner, D'Eugenio et al. 1999, Saeed and Sun 2012). In the N+D configuration, the effluent from the first wetland (with a high content of  $\text{NO}_3^-$  produced by nitrification process), is incorporated in to the second wetland in a continuous regimen. The anaerobic condition in the last wetland will allows the denitrification process of the oxidized nitrogenous compounds producing  $\text{N}_2$ . However, other biochemical process could be developed in the wetlands as the coupled elimination of nitrate ( $\text{NO}_3^-$ ),  $\text{NH}_4^+$ , and the  $\text{CH}_4$  remains in the digester effluent by the Anaerobic Oxidation of Methane (AOM) (Haroon, Hu et al. 2013) (Figure 18). In this process the  $\text{NH}_4^+$  is converted, coupled with  $\text{NO}_3^-$  or  $\text{NO}_2^-$ , in  $\text{N}_2$  using  $\text{CH}_4$  as an electron donor. A mixture of these substrates and the presence of these microorganisms in the environment could be produced the N-compound liberation to the atmosphere without environmental impacts. Additionally, the  $\text{CH}_4$  remains in the liquid phase in the output of the digester, could be removed and release it to the environment as  $\text{CO}_2$ , declining its environmental effect. Moreover, the Anaerobic Ammonium Oxidation (Anammox) process can remove the  $\text{NH}_4^+$  and  $\text{NO}_3^-$  or nitrite ( $\text{NO}_2^-$ ) coupled as  $\text{N}_2$ . This process uses the  $\text{NO}_2^-$  as electron acceptor instead of electron donating capacity of the  $\text{NH}_4^+$ . The Anammox and the AOM processes are newer biological process found in the environment (Joye 2012, Haroon, Hu et al. 2013, He, Niu et al. 2015).

Though the N-compound removal by wetlands has been widely studied, the evidence of the AOM and the Anammox processes could mean an innovative application of these biochemical systems in the wastewater treatment processes. The design and subsequent construction of two wetlands working in a series configuration, but with different feed regimens, could be produce relevant information about tertiary low-cost treatment processes.

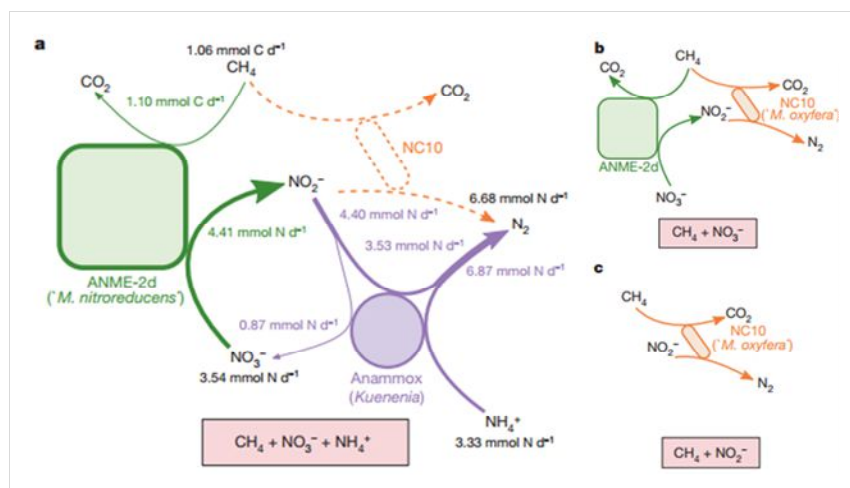

**Figure 18.** Anammox and AOM processes in the biological reactors according to Haroon *et al.* (Haroon, Hu et al. 2013). a. Interactions under  $\text{CH}_4$ ,  $\text{NO}_3^-$  and  $\text{NH}_4^+$  conditions. b. Interactions defined in a reactor feeding with  $\text{CH}_4$  and  $\text{NO}_3^-$  in a *M. nitroreducens* and *M. oxysfera* co-culture. c. Interactions in a reactor feeding with  $\text{CH}_4$ , y  $\text{NO}_2^-$  in a *M. oxysfera* pure culture.

### 2.3.4. Pathogens removal

Moreover, another issue to determine in the lab-scale valorization system is the pathogen removal efficiencies. The strategies to achieve the standards for the effluent discharge in the water bodies or irrigation are known it. For the stabilization of the anaerobic sludge, flocculation, membrane macrofiltration and the later drying will be designed; while a maturation pond will be the final removal method for the wetland effluent. Whereas removal parameters are been identified for the separated systems and these will be used for the design, a reliable estimation in the faecal coliforms (FC) and Helm for a similar completely system are not available.

Thereby, the reduction in the pathogen presence in the stabilized sludge and in the clarified effluent could need the addition of the chemical products. In the case of the standards for the recycle purposes do not achieved, lime (CaO) in the sludge and titanium dioxide (TiO<sub>2</sub>) in the effluent must be applied. The methods involved in the pathogens removal by the chemical products are the increment of pH in the CaO addition and the photocatalytic ultraviolet degradation of the biomass in the TiO<sub>2</sub> case (Pritchard, Penney et al. 2010, Keane, McGuigan et al. 2014).

The study of the pathogen removal is an important aspect to consider in the feasibility of the planned valorization system because the operative costs will be rise by the chemical addition scenarios.

## 2.4. Feasibility

As can be predicted, the main risks for the development of the valorization technology are the factors that affect the productivity and removals, the business model to be applied and the environmental and economical conditions. A study of these for the technology development by the future scenarios definition is needed. However, the fluctuation in the scenarios and their profitability produces a high risk in the investment. On the other hand, the definition of the different scenarios can be improved the knowledge of the future performance of the full-scale system. In conclusion, the implementation of a full-scale valorization system in the dairy production system is needed to determine the real feasibility of the technological hypothesis planned and its application in small- and medium-scale farms.

### 2.4.1. Technological risks

The planned valorization system has a high technological risk given mainly by the estimation in the biogas production and pathogen removal in the process. The estimation of the CH<sub>4</sub> production using models is complex, the distance between the approaches are too big and it is difficult to do a correct estimation of this productivity (Kythreotou, Florides et al. 2014). Moreover, the reported biogas production rates depend of the type and the operation of the anaerobic reactor involved in each experiment. Consequently, the CH<sub>4</sub> production has been estimated by these biogas production rates previously reported and classified in three different scenarios (Table 3). Firstly, the biogas production considering the AcD of the CM and GLY in a proportion of 5 % of the TS (GLY5), following by the AD of CM with high production rates (HIGH), and finally the AD of CM where the biogas production rates were lower (LOW).

**Table 3.** Biogas production rates reported.

Scenario	Reference	Reactor	Temperature	OLR	HRT	Biogas production rates
			°C	gCOD/L.d	d	L <sub>biogas</sub> /KgVS <sub>added</sub>
GLY5	(Robra, Serpa da Cruz et al. 2010)	CSTR	37	3	25	825
GLY5	(Timmerman, Schuman et al. 2015)	CSTR	37	3	20	487
GLY5	(Castrillón, Fernández-Nava et al. 2011)	Batch, sonication	55	-	40	291
HIGH	(Amon, Amon et al. 2006)	-	-	-	-	286
HIGH	(Robra, Serpa da Cruz et al. 2010)	CSTR	37	3	25	269
LOW	(Timmerman, Schuman et al. 2015)	CSTR	37	3	20	200
LOW	(Lo, Chen et al. 1986)	AnRBC	35	3	11	93

The previous table shows that the fluctuation in the different approaches is significant by the differences in the anaerobic reactor operation. Consequently, three technological scenarios have been defined about the CH<sub>4</sub> production to predict the behaviour of the lab-scale system. The first one (GLY5), a favourable scenario was established considering the AcD of CM with GLY. Secondly, the medium scenario was defined by the approaches with the best results for the CM digestion (HIGH). Finally, the unfavourable scenario for the biogas production was predicted based in the works of Timmerman *et. al.* in 2015 and Lo *et. al.* in 1986 (LOW). As a consequence, the mixture between GLY and the CM produces a significant increment in the production but the rise in the operation costs must be consider by the purchase of the residue to the biodiesel companies.

Another factor that affects the profitability and the technological feasibility is the pathogen removal in the anaerobic sludge and in the clarified effluent. The presence of FC and Helm determine the employment of these by-products. World Health Organization (WHO) standards are used as reference in the land application of effluents or stabilized sludge in agriculture without limitation (less than 1000 CFU/100mL and less than 1 helminth ova/L in the effluent or in the sludge) (WHO 1989). Even though the pathogen removal stipulated for this type of systems predicts a low presence of pathogens in the final of the processes, the addition of the chemical products as disinfectant must be consider when it is needed (Pritchard, Penney et al. 2010, Keane, McGuigan et al. 2014).

#### 2.4.2. Economical risks

The feasibility of the valorization system depends of the technologic development but also of economical condition where the system will be installed and this is generally affected by two different factors. Firstly, the macroeconomics factors as the inflation, the exchange rate and the salary of the rural workers affect deferentially each component of the incomes and the O&M costs of the full-scale systems. On the other hand, other factors that affect the profitability of the systems are related with the nutrients recovery and the GW saving in the

establishment. The earnings produced by these last factors are difficult to predict due to the economical values are subjected added because they are environmental variables.

According to the nutrients recycle, it is important to remark that the P and N recycles in the production process would be by the application of the stabilized sludge and the irrigation of the treated effluent in the land. Furthermore, the sludge content also a big amount of other macronutrients as well as essential micronutrients for grow up of the vegetables, adding extra value into the nutrients recycles. The estimation of the economical saving in the GW consumption requires a detailed study. This is due to that in Uruguay the water consumption for the agricultural activities do not have costs for the farmers (always when it comes from surface water or GW, no drinking water). However, this do not reflex the reality of the country because the lack of water to drought events has an intangible costs for the farmers. The valorization system will allows saving GW to cleaning activities producing a significant decline of the daily water consumption.

In conclusion, the economical scenarios set up for the nutrients and water recycle would determine arbitrarily according to their subjective values. However, the macroeconomic aspects are not considered in the present work.

## CHAPTER 3

# Methodology and materials

### 3.1. Content overview

- I. Evaluation of the behaviour and the kinetic of a lab-scale anaerobic digester considering the codigestion and the water recycle processes.
  1. Characterization and determination of the influent fractions (initial characterization, unbiodegradable particulate fraction and overall molecular formula)
  2. Evaluation of cosubstrate mixtures in the AcD process (effluent, crude glycerol and the water recycle evaluated in the pH and alkalinity effects).
  3. Biogas production rate determination in steady state conditions.
  4. Stoichiometric and mass balance of the AcD process.
  5. Kinetic evaluation of the hydrolysis/acidogenic processes (Monod vs 1<sup>ST</sup> order specific) using the methane production rates.
- II. Assessment of the performance of the secondary and tertiary treatment as tools to save water consumption in the farm.
  6. Nitrogen behaviour in the secondary and tertiary treatment (stone filters and pond).
  7. Study of the removal efficiency of nutrients and pathogens in the overall wastewater treatment system.
- III. Design of a full-scale dairy farm waste valorisation system, based on the inputs obtained from the examination of the lab-scale anaerobic digester.
  8. Process flow diagram.
  9. Preliminary design (primary treatment, anaerobic reactor, sludge dewatering, constructed wetland, pond and biogas line).
  10. Layout.
- IV. Preliminary financial evaluation of the technology implementation in a full-scale production system.
  11. Balance sheet determination (investment cost, incomes and O&M costs)
  12. Profitability evaluation (internal return rate, payback period and net present value).

## 3.2. Set up and experimental design of the lab-scale system

### Set up of the valorization system

The lab-scale system was composed by the primary, secondary and tertiary treatments (Figure 19). Firstly, the anaerobic section was built by a CSTR and a sedimentation tank as an ACP. Both types of the operational reactors were combined to work with uncoupled HRT and SRT by the sludge recycle process from the settler to the stirred tank. Two serial stone filters were used as secondary treatment to remove some solids and nitrogen compounds. Finally, a pond was installed in the end of the water line and a sludge drying bed in the end of the sludge line. The photos of the installation are presented in the Appendix chapters and a diagram is shown in the figure below (Appendix A, Figure 48).

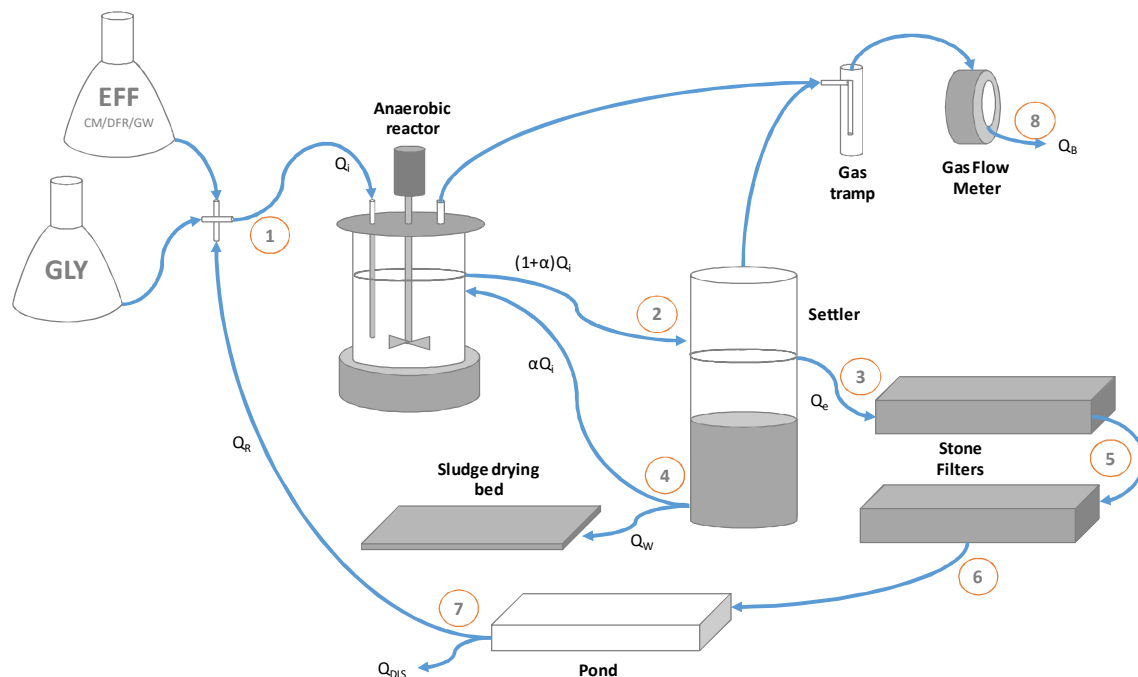

**Figure 19.** Lab-scale system diagram and sampling points.

A New Brunswick® Scientific BioFlo III Batch/Continuous Benchtop Fermentor was used as the anaerobic reactor, which was facilitated by the Faculty of Chemistry of Universidad de la República (UdelaR). The reactor was equipped with a pH and a dissolved oxygen (DO) electrodes (to control pH and check the anaerobic conditions), a rotor to ensure a proper mixture inside the vessel and one peristaltic pump to move the flows. Since both electrodes were broken in the course of the experiments, in situ pH and DO measurements were not carried out for the whole assay. Nevertheless, the pH of the reactor was determined by the sampling at point 2 and measured immediately. This reactor worked with 2.65 L of effective volume and HRT = 3.5 d in this section. The biomass recycle from the settler was used to inoculate the reactor permanently and to increase the solids concentration inside ( $13.07 \pm 0.52$  gTS/L). This sludge recycle factor applied was  $\alpha = 0.039$  (30 mL/d) when the system was stabilized. While the digester medium was continuously stirred at 100 rpm, the stirring rate was modified to 250 rpm to feed the reactor due to the scum problems (Appendix A, Figure 50). Although the optimal mesophilic temperature for the AD process is

37 °C (Pavlostathis and Giraldo-Gomez 1991), the temperature chosen for the assay was 30 °C. This is because all the data obtained from this lab-scale design will be used for the full scale valorisation system version where the heating cost to 37 °C would decline its feasibility. Moreover, the room temperature where the system was installed was kept at 30 °C to decrease the daily fluctuations.

Additionally, the system was composed by a cylindrical tank as settler with an inlet pipe from the reactor, an outlet pipe for the supernatant, an outlet pipe for the sedimented sludge and a pipe to catch the biogas produced in this part. This settler had 4.90 L of the liquid volume composed by 2.45 L of the supernatant and 2.45 L of the sedimented approximately. The settler was mixed 30 min before the feeding process to destabilize the scum formed during the night. The lab-scale system was fed with 0.755 L/d to obtain HRT = 10 d in the anaerobic zone. However, the SRT was kept by the control of the waste sludge around 50 d in the assay to ensure the hydrolysis of the particulate organic matter (33 mL/d, 0.044 of influent flow). The following equation was applied to determine the SRT in the anaerobic system (Equation 3).

$$(3) \quad SRT = \frac{TSS_{\text{Reactor}} \cdot V_{\text{Reactor}} + TSS_{\text{Sedimented}} \cdot V_{\text{Sedimented}} + TSS_{\text{Supernatant}} \cdot V_{\text{Supernatant}}}{TSS_{\text{waste}} Q_w + TSS_{\text{effluent}} Q_e}$$

A gas tramp and a gas flow meter (Schlumberger®, appreciation of 0.005 dm<sup>3</sup>) were used in the gas line. The biogas productions were measured every day after to destabilize the scum formed in the anaerobic system and before to start the feeding process. Moreover, the sludge removed by the SRT control was dried at room temperature above of the sludge drying bed.

Following the water line, as a continuation of the supernatant of the settler, two stone filters in series were used to remove some solids and to promote the N+D processes. The stone filters were built using polystyrene trays and filled with washed stones of 20-50 mm of particulate diameter. The dimensions of these stone filters were 39 cm x 29 cm x 11 cm (LxWxH), and the trays were divided in two to improve the L/W ratio.

Finally, the effluent of the stone filters was stored in a pond to improve the tertiary treatment and to reuse it as an influent of the system instead of the GW (recycle flow). A polystyrene tray was used again and its dimensions were 29 cm x 21 cm x 3.2 cm (LxWxH), consequently the HRT = 3.6 d was achieved in this component of the system.

### Experimental design

The anaerobic reactor was inoculated using anaerobic sludge extracted from a silted anaerobic pond that actually treats the CM produced in the farm, and with high biological activity (evidenced by the production of gas in natural conditions). A third part of the total reactor volume was filled with this anaerobic inoculum and the system was fed every day with a progressive increment of Organic Loading Rate (OLR) in the start up of the anaerobic process. The influent mixture of the valorization system was composed by the effluent of the farm previously evaluated. The CM, DFR and GW were used in the effluent preparation (EFF) (Figure 20). In the beginning of the lab-scale assay, the system was fed with the EFF mixture as the initial condition, from the start up to the steady state condition was achieved (after 52 days of the operation). The OLR in this period was 3.09 ± 0.32 gCOD/L.d with an experimental SRT = 52.3 ± 3.8 d.

After the initial conditions of the system were determined, the GLY was supplied as cosubstrate to improve the biogas production. The GLY was added to the influent mixture instead of the CM and DFR to keep the same solids content between both sets of conditions.

A progressive increment of GLY in the influent mixture was applied to determine the optimal mixture between EFF and GLY. The 5 % and 10 % of the influent TS was changed by GLY and evaluated. In order to solve some problems with the acid/base equilibrium in the system, extra alkalinity was used in the influent mixture as  $\text{Na}_2\text{CO}_3$  (350 mg $\text{CaCO}_3/\text{L}$ ). The steady state condition for the GLY5+Extra alkalinity step was achieved after 75 days of the reactor operation, with  $\text{OLR} = 3.69 \pm 1.46$  gCOD/L.d and  $\text{SRT} = 50.1 \pm 4.0$  d. However, at this point the Alk was substituted by the effluent of the system in the GLY5+R step. In this manner, the effluent of the system was recycled and a part of the 0.7 L/d of the GW in the EFF was substituted by 0.4 L/d of the recycle flow ( $\text{pH} = 8.51 \pm 0.29$  and  $\text{Alk} = 1.06 \pm 0.06$  g $\text{CaCO}_3/\text{L}$ ). After the steady state condition was achieved, the  $\text{OLR} = 4.39 \pm 0.21$  gCOD/L.d and  $\text{SRT} = 46.1 \pm 4.9$  d were measured (at day 84 of the assay).

Finally, the GLY was increased from 5 % to 10 %. In this new setting, the steady state condition was achieved after 95 days of the assay. The operational parameters measured were  $\text{OLR} = 4.32 \pm 0.31$  gCOD/L.d and  $\text{SRT} = 46.9 \pm 2.7$  d (GLY10+R condition). Consequently, with the addition of GLY and the successive effluent recycles, the accumulation of the  $\text{COD}_s$  and the  $\text{PO}_4^{3-}$  in the anaerobic system were evidenced (Appendix D).

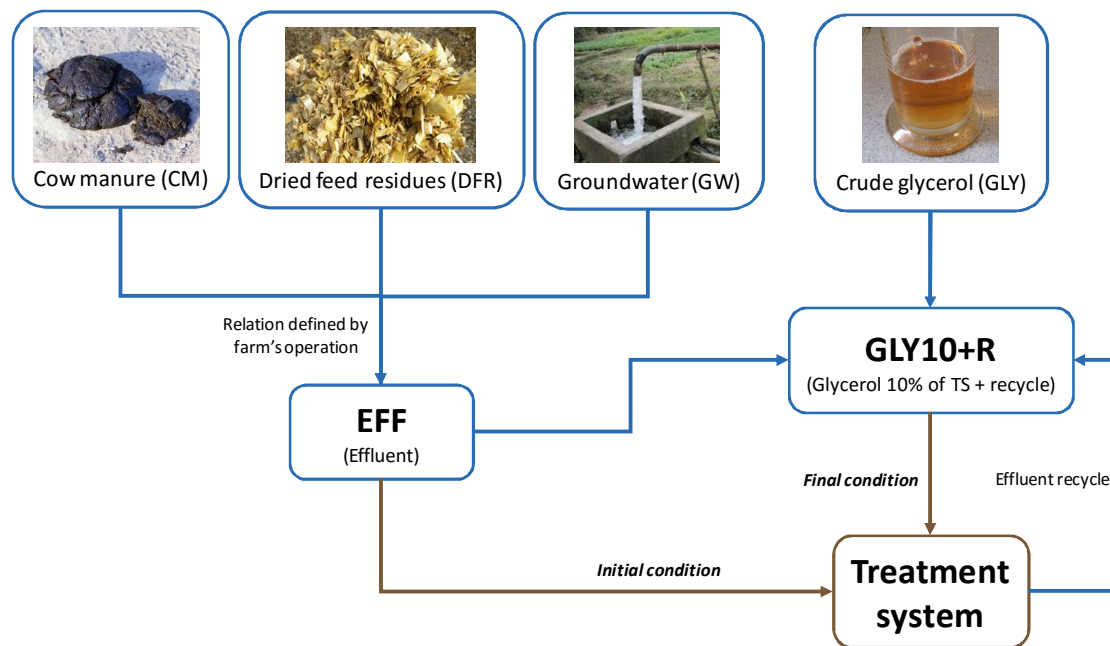

**Figure 20.** Feeding regimen of the treatment system.

The pH in the reactor and the flow of the biogas produced ( $Q_B$ ) were measured every day. However, the COD, Alk, Total Acidity (TAc) and the VFA concentration were determined each 3 days. These parameters were used to define that the steady state conditions were achieved. In these periods, the pH, Alk, VFA,  $\text{COD}_T$ , Total Suspended Solids (TSS), Volatile Suspended Solids (VSS),  $\text{NH}_4^+$ ,  $\text{NO}_3^-$ ,  $\text{NO}_2^-$ , TKN,  $\text{PO}_4^{3-}$  and TP were measured every day by three days to obtain triplicates results. Additionally, the sludge concentration factor in the settler ( $\beta$ ) was measured based in  $\beta = \text{TSS}_w/\text{TSS}_e$  to understand the efficiency of the settler ( $\beta = 18.3 \pm 1.0$ ).



The system produced gas everyday consequently with the additions. Nevertheless, the first COD mass balance in the anaerobic section evidenced losses of biogas from the system. After 49 days of the experiment, the leaks were found and solved and the assay was carried out with a proper biomass balance.

The scum produced in the reactor and in the settler generated some fluctuations in the biogas measures, so the scum needed to be removed before all the measurements took place.

### 3.3. Analytical determination and analysis

#### Analytical methods

The Spectroquant® Move 100 was used in the determination of the COD,  $\text{NH}_4^+$ ,  $\text{NO}_3^-$ ,  $\text{NO}_2^-$ ,  $\text{PO}_4^{3-}$  and TP. This spectrophotometer needed some reagents supplied by Millipore®. Moreover, the equipment was calibrated by the Spectroquant® verification standards, and the analytics methods were validated using the Combichex® kits to ensure the legitimacy of the results. The COD and the TP samples were digested by the Thermoreactor® TR 320 (2 h at 148 °C and 30 min at 120 °C, respectively). Additionally, the samples were previously filtered using filter paper of 0.45 µm to determine the  $\text{COD}_s$ ,  $\text{NH}_4^+$ ,  $\text{NO}_3^-$ ,  $\text{NO}_2^-$  and  $\text{PO}_4^{3-}$  parameters. In the following table is summarized all the parameters, measuring range and methods (Table 4).

**Table 4.** Kits used in the analytical determinations by the Spectroquant® (APHA 2005, Millipore 2014).

Parameter	Symbol	Kit Number	Measuring range		APHA standard method
			Value	Unit	
Chemical oxygen demand	COD	1.14541.0001	25 - 1500	mgCOD/L	5220 D-Closed reflux, dichromate
Free and saline ammonium	$\text{NH}_4^+$	1.14752.0001	0.02 - 1.30	mgN-NH <sub>4</sub> /L	4500-NH <sub>3</sub> F-Phenate
Nitrate	$\text{NO}_3^-$	1.14773.0001	0.5 - 15.0	mgN-NO <sub>3</sub> /L	4500-NO <sub>3</sub> E-Cadmium reduction
Nitrite	$\text{NO}_2^-$	1.14776.0001	5 - 400	µgN-NO <sub>3</sub> /L	4500-NO <sub>2</sub> B-NED dihydrochloride
Phosphate	$\text{PO}_4^{3-}$	1.14729.0001	0.5 - 20.0	mgP-PO <sub>4</sub> /L	4500-P D-Stannous chloride
Total phosphorous	TP				

The TN concentrations were calculated by the sum between the  $\text{NO}_3^-$ ,  $\text{NO}_2^-$  and the TKN concentrations. These TKN analysis were outsourced by the accredited laboratory Ecotech and the 4500-N<sub>org</sub> B macro-Kjeldahl standard method was used to determine it (APHA 2005).

The TS, VS, TSS and VSS were determined using the APHA standard methods (2540 B, 2540 G and 2540 D) (APHA 2005). The samples were filtered using the glass filter with a pore size of 0.45 µm to measure the suspended solids (TSS and VSS). While the total solids were dried at 103-105 °C to constant weight by overnight period (TS and TSS), the volatile solids were incinerated at 550 °C for 2 h until constant weight (VS and VSS) (Equations 4 to 7).

$$(4) \quad \text{TS} = \frac{(A - B) \times 1000}{V_{\text{Sample}}} \quad (\text{in gTS/L})$$

$$(5) \quad VS = \frac{(A - C) \times 1000}{V_{\text{Sample}}} \quad (\text{in gVS/L})$$

$$(6) \quad TSS = \frac{(D - E) \times 1000}{V_{\text{Sample}}} \quad (\text{in gTSS/L})$$

$$(7) \quad VSS = \frac{(D - F) \times 1000}{V_{\text{Sample}}} \quad (\text{in gVSS/L})$$

Where:

A = Weight of the dried residue and dish (mg).

B = Weight of the dried empty dish (mg).

C = Weight of the incinerated residue and dish (mg).

D = Weight of the dried filtered residue and dish (mg).

E = Weight of the dried empty dish and filter (mg).

F = Weight of the incinerated filtered residue and dish (mg).

$V_{\text{Sample}}$  = Volume of the sample (mL).

The Alk was measured following the APHA standard method 2320 B (APHA 2005). The titration of the sample until the end-point of pH = 4.3, was done with a solution of hydrochloric acid ( $\text{HCl}_{\text{aq.}} \approx 0.05\text{N}$ ) and using a pH electrode due to the turbidity of the samples (Equation 8). Additionally, the TAc were determined in the same assay but the end-point was pH = 3.0 by the APHA standard method 2310 B (Equation 9). Moreover, after that the  $\text{CO}_2$  was released by reflux from the sample titrated until pH = 3.0, the VFA concentration was determined by the titration until the end-point of pH = 6.5 with a solution of sodium hydroxide ( $\text{NaOH}_{\text{aq.}} \approx 0.1 \text{ N}$ ) (Equation 10) (Field and Sierra 1989).

$$(8) \quad \text{Alk} = \frac{V_{\text{HCl}=4.3} \times N_{\text{HCl}} \times 50000}{V_{\text{Sample}}} \quad (\text{in mgCaCO}_3/\text{L})$$

$$(9) \quad \text{TAc} = \frac{V_{\text{HCl}=3.0} \times N_{\text{HCl}} \times 1000}{V_{\text{Sample}}} \quad (\text{in meq/L})$$

$$(10) \quad \text{VFA} = \frac{V_{\text{NaOH}=6.5} \times N_{\text{NaOH}} \times 1000}{V_{\text{Sample}}} \quad (\text{in meq/L})$$

Where:

$V_{\text{HCl}=4.3}$  = Volume of standard acid used in titration until the end-point pH = 4.3 (mL).

$N_{\text{HCl}}$  = Normality of the standard acid used (N).

$V_{\text{Sample}}$  = Volume of the sample (mL).

$V_{\text{HCl}=3.0}$  = Volume of standard acid used in titration until the end-point pH = 3.0 (mL).

$V_{\text{NaOH}=6.5}$  = Volume of standard base used in titration until the end-point pH = 6.5 (mL).

$N_{\text{NaOH}}$  = Normality of the standard base used (N).

Additionally, the VFA components concentrations were outsourced and determined by Gas Chromatography (GC). The National Institute of Agricultural Research (INIA) was the laboratory chosen to apply the APHA standard method 5560 B (APHA 2005). Further, the methane concentrations were measured by the Environmental Microbiology Department of UdelaR and also the GC method was used (Tarlera, Capurro et al. 2016). The Gly and Met

were determined using GC and provided by the supplier of the samples (ALUR). Moreover, the FC measurements were done using the filtration method for the liquid samples (Colony-forming units, CFU) or the Most Probable Number (MPN) for the solids samples. These microbiology analyses were outsourced by the accredited laboratory of Technological Laboratory of Uruguay (LATU). Finally, the LATU was the laboratory chosen to determine the potassium concentrations ( $K^+$ ), by Atomic Absorption Spectroscopy (AAS); and the elemental analysis (CHONS) by incineration and AAS.

### Statistics analysis

Triplicate measures ( $n = 3$ ) were taken of each sample to determine the variation of the determination. The statistic analysis of the experimental data was done following the Student's t-distribution of the results under the null hypothesis. The level of significance chosen was 0.05, and the coefficients value ( $Z$ ) was 4.3027 for 2 degrees of freedom. The Confidence Interval (CI) was calculated based in the standard deviations ( $\sigma$ ) to define the confidence of the results (Equation 11). Additionally, the Coefficient of Variation (CV) was used to represent the variation of the measures in percentage corresponding with the averaged value ( $X$ ) (Equation 12).

$$(11) \quad CI = Z \frac{\sigma}{\sqrt{n}} = 4.3207 \frac{\sigma}{\sqrt{3}}$$

$$(12) \quad CV = \frac{\sigma}{X} \times 100 \quad (\text{in } \%)$$

## 3.4. Evaluation of the behaviour of the anaerobic codigestion process

### 3.4.1. Characterisation and determination of influent fractions

#### Initial characterisation

As presented in the background chapter, a previous field study showed that the effluent produced by the cleaning process in the dairy farm was composed mainly by CM (86 % of TS), DFR (14 % of TS) and GW (63 m<sup>3</sup>/d) (Figure 20). Consequently with the daily waste production, the stormwater caught (3.2 m<sup>3</sup>/d) and the recover fraction (0.9), the final effluent has approximately 12 KgTS/m<sup>3</sup> with a load of 740 KgTS/d (60 m<sup>3</sup>/d of EFF).

The farm's wastes and the GW were obtained from the ERB farm. This farm had actually 180 milking Holland cows with a feeding regimen of 26 KgTS/d.V<sub>0</sub> between meadow and supplements (6 Kg/d.V<sub>0</sub>). The farm is located in Kiyú, San José-Uruguay (34°36'06.1"S 56°42'52.0"W) and the owners plan to increase the number of cows until 250 V<sub>0</sub> in the following years. The climate in this zone is mainly temperate and wet with seasonal fluctuations, a mean annual precipitation of 1200 mm and an average annual temperature of 17 °C (12 °C in winter and 22 °C in summer) (INIA-GRAS 2011).

The GLY was obtained from an industrial plant in Montevideo (ALUR) which mainly produces biodiesel by the transesterification of soybean oils with methanol and potassium hydroxide. The CM was collected from the floor of the milking zone and stored between 0-10 °C without headspace until its utilization within the shortest time possible (15 days approximately). After collection from the silage, the feed residues were dried by the direct effect of the sunshine (5

hours), milled at 0.5 mm of mesh size and stored between 0-10 °C to obtain the DFR used in the anaerobic reactor. The GLY and the GW were saved at room temperature in closed bottles.

The parameters measured for each residue are presented below (Table 5). Three measures of each matrix were determined to get representative results and to estimate the variability of the analytical determination by the Student's t-test.

**Table 5.** Parameters determined in the initial characterization.

Parameter	Symbol	CM	DFR	GLY
Total solids	TS	X	X	X
Volatile solids	VS	X	X	X
Total suspended solids	TSS	X	X	X
Volatile suspended solids	VSS	X	X	X
Total chemical oxygen demand	COD <sub>T</sub>	X	X	X
Hydrogen ions	pH	X	X	X
Free and saline ammonium	NH <sub>4</sub> <sup>+</sup>	X	X	
Nitrate	NO <sub>3</sub> <sup>-</sup>	X	X	
Nitrite	NO <sub>2</sub> <sup>-</sup>	X	X	
Total Kjeldahl nitrogen	TKN <sub>T</sub>	X	X	
Phosphate	PO <sub>4</sub> <sup>3-</sup>	X	X	
Total phosphorous	TP	X	X	
Faecal coliforms	FC	X		
Glycerol	Gly			X
Methanol	Met			X
Potassium	K <sup>+</sup>			X

A complete characterisation of the wastewater was done to predict the kinetic and the stoichiometric of the AcD process. For this reason, the unbiodegradable particulate fraction ( $f_{upi}$ ) and the overall molecular formula of the biodegradable COD (COD<sub>B</sub>) in the influent wastewater were determined.

The complete characterization of the wastewater was done in two different conditions. The initial, when the system was fed using only the effluent of the farm (EFF), and the final condition where the optimal mixture between EFF and GLY was determined (GLY10+R).

### Unbiodegradable particulate fraction ( $f_{upi}$ )

The fractionation of the influent total COD (COD<sub>T,i</sub>), by the determination of the  $f_{upi}$ , allowed predicting the amount of organic matter available to be used as nutrient in the AcD process (Ekama, Dold et al. 1986, Söttemann, Ristow et al. 2005) (Figure 21). The  $f_{upi}$  shows the characteristic of the wastewater to be treated and it is defined as the ratio between the particulate COD that was not broken down in these particular conditions ( $X_i$ ) and the COD<sub>T,i</sub>. The COD<sub>T,i</sub> and the soluble COD (COD<sub>S,i</sub>) were directly measured, filtering the samples with a glass-filter of 0.45 µm, and the particulate COD (COD<sub>X,i</sub>) calculated by the difference.

In the steady state conditions of the AcD process, the COD<sub>S</sub> in the effluent is composed mainly by the soluble unbiodegradable COD (S<sub>i</sub>). This assumption is viable for processes

with high SRT, due to  $S_i$  is the same before and after of the anaerobic digester. The direct determination of this effluent  $COD_S$  allowed the fractionation of  $COD_{S,i}$  in  $S_i$  and in the soluble biodegradable COD ( $S_S$ ). However, the fractionation of the  $COD_{X_i}$  requires the determination of  $f_{upi}$ .

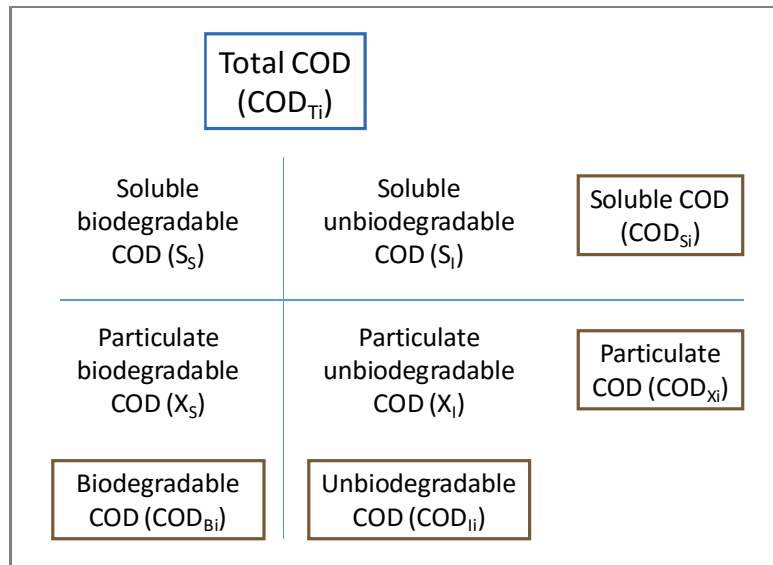

**Figure 21.** Influent COD fraction for the steady state anaerobic codigestion model.

The estimation of the particulate biodegradable COD ( $X_S$ ) was done using an Anaerobic Biodegradability test (AB) (Field and Sierra 1989) instead of Biological Oxygen Demand (BOD) in aerobic treatment systems. The influent biodegradable COD ( $COD_{B,i}$ ) is the COD consumed by fermentative and methanogenic microorganisms in the anabolic (acidified COD,  $COD_{ACID}$ ) and in the catabolic process (COD in biomass,  $COD_{BIOM}$ ) (Equations 13 and 14). During the AB test, the  $COD_{ACID}$  was directly measured by the sum of the produced COD as methane ( $S_m$ ) and the COD in the volatile fatty acids ( $COD_{VFA}$ ). Additionally, the biomass production ( $COD_{BIOM}$ ) was estimated based in the expected biomass yields for the acidogenic and methanogenic process separately ( $Y_{AD}$  and  $Y_{MET}$  respectively). The overall biomass yield ( $E$ ) in the anaerobic process for this particular substrate could be estimated as the sum between these specific yields (Equation 14).

$$(13) \quad COD_{B,i} = COD_{ACID} + COD_{BIOM} = S_m + COD_{VFA} + COD_{BIOM}$$

$$(14) \quad COD_{BIOM} = (Y_{AD} + Y_{MET}) \times COD_{T,i} = E \times COD_{T,i}$$

These biomass yields were calculated according the reported values of the separated biomass yields of acidogenic ( $Y_{AC,R}$ ) and methanogenic ( $Y_{MET,R}$ ) microorganisms (Pavlostathis and Giraldo-Gomez 1991); the percentage of acidification ( $\%A_t$ ) and the percentage of methanogenization ( $\%M_t$ ) (Equations 15 to 18). The  $\%A_t$  and the  $\%M_t$  were related to the  $COD_{T,i}$  instead of the  $COD_{X,i}$  because the influent is composed by particular and soluble organic matter.

$$(15) \quad \%A_t = \frac{COD_{ACID,t}}{COD_{T,i}} \times 100$$

$$(16) \quad \%M_t = \frac{S_{m,t}}{COD_{T,i}} \times 100$$

$$(17) \quad Y_{AD} = \%A_t \cdot \left[ \frac{1}{(1 - Y_{AD,R})} - 1 \right] \quad \text{where } Y_{AD,R} = 0.15$$

$$(18) \quad Y_{MET} = \%M_t \cdot \left[ \frac{1}{(1 - Y_{MET,R})} - 1 \right] \quad \text{where } Y_{MET,R} = 0.03$$

The percentage of biodegradability could be calculated (%BD<sub>t</sub>) as the sum between the %A<sub>t</sub> and the E (Field and Sierra 1989). Finally, the f<sub>upi</sub> could be estimated based in the COD<sub>T,i</sub>, the %BD<sub>T</sub> and the S<sub>i</sub> (Equations 19 and 20).

$$(19) \quad \%BD_{T,t} = \%A_t + E = \%A_t + Y_{MET} + Y_{AD}$$

$$(20) \quad f_{upi} = \frac{X_I}{COD_{T,i}} = \frac{COD_{T,i} - S_i - COD_{B,i}}{COD_{T,i}} = \frac{(COD_{T,i} - S_i) - (COD_{T,i} \times \%BD_{T,t})}{COD_{T,i}}$$

The assay was carried out for 26 days at 29.5 ± 3.5 °C, using a stirred batch anaerobic digestion process (1 L of reaction mixture) and monitoring the cumulative methane produced and the concentration of VFA (Field and Sierra 1989) (Appendix A, Figure 47). The cumulative S<sub>m</sub> was estimated by periodic measurements of the biogas volume with an open-end manometer (using water as manometer liquid) and a determination of the methane concentration in the biogas using GC. Additionally, the biogas volumes were corrected by the temperature using the Charles's law to normalize the system at T = 30 °C. In the other hand, the VFA concentration was sporadically determined by the titration method (each 3 days), before and after of volatilize the CO<sub>2</sub> by reflux. The estimation of the COD<sub>VFA</sub> was done by the determination of the C2:C3:C4 concentrations in the VFA mixture using GC. In the beginning of the assay, the COD<sub>T,i</sub>, the TS and the IS were measured, while after 25 days the S<sub>i</sub> was estimated as the soluble COD in the reaction vessel.

The assay was composed by three batch bottles, a control, the initial condition (EFF) and the final condition (GLY10+R). The amount of the components in each vessel is showed in the following table (Table 6).

**Table 6.** Initial composition in the vessels of ABA test (1 L of reaction mixture).

Component	Unit	Control	EFF	GLY10+R
Inoculum	mL	158	158	158
Cow manure	g	0	99.1	88.9
Dried feed residue	g	0	2.45	2.20
Glycerol	g	0	0	1.86
Recycle	mL	0	0	500
Groundwater	mL	0	842	342
Distilled water	mL	842	0	0

## Overall molecular formula

The overall molecular formula of  $COD_{B,i}$  was determined for the initial and the final conditions (EFF and GLY10+R) to understand the mass balances in the AcD process. It was based in the carbon ( $f_C$ ), nitrogen ( $f_N$ ) oxygen ( $f_O$ ), hydrogen ( $f_H$ ) and phosphorus ( $f_P$ ) fractions in VSS as an estimation of the organic matter. With the aim to simplify the calculations, the  $S_S$  and  $X_S$  were grouped (as  $COD_{B,i}$ ) assuming that the all  $COD_{B,i}$  was used in the hydrolysis of the polymers as limiting step of the AcD process. Additionally, the  $S_I$  was considered negligible. The element fractions in the  $X_I$  are given by previous works (Ekama 2015), so the elements fractions in the  $COD_{B,i}$  could be calculated from this last one (Table 7).

**Table 7.** Fractions of elements in each component of  $COD_{T,i}$ .

Component	$f_{CV}$	$f_C$	$f_N$	$f_P$
	gCOD/gVSS	gC/gVSS	gN/gVSS	gP/gVSS
$X_I$	1.481	0.518	0.100	0.025
$COD_{B,i}$	From (24)	From (25)	From (25)	From (25)

The hydrogen and oxygen content in the  $X_I$  ( $f_{H(X_I)}$  and  $f_{O(X_I)}$ , respectively), were calculated using the followings equations and based in the values reported (Ekama 2015) (Equations 21 and 22). Additionally, the fractions were confirmed with the results of the sum of them equal to 1.000 (Equation 23).

$$(21) \quad f_{H(X_I)} = \frac{1}{9} \left[ 1 + f_{CV(X_I)} - \frac{44}{12} f_{C(X_I)} + \frac{10}{14} f_{N(X_I)} - \frac{71}{31} f_{P(X_I)} \right] = 0.066$$

$$(22) \quad f_{O(X_I)} = \frac{8}{9} \left[ 1 - \frac{1}{8} f_{CV(X_I)} - \frac{8}{12} f_{C(X_I)} - \frac{17}{14} f_{N(X_I)} - \frac{26}{31} f_{P(X_I)} \right] = 0.291$$

$$(23) \quad f_{C(X_I)} + f_{O(X_I)} + f_{H(X_I)} + f_{N(X_I)} + f_{P(X_I)} = 1.000$$

The COD content in the VSS are defined as  $f_{CV}$ . If the VSS is fractionated in its corresponding components ( $COD_{B,i}$  and  $X_I$ ), the COD in the biodegradable VSS is expressed by the following equation (Equation 24).

$$(24) \quad f_{CV(COD_{B,i})} = \frac{COD_{B,i}}{\left[ VSS - \frac{X_I}{f_{CV(X_I)}} \right]}$$

The same analysis was applied for the carbon, nitrogen and hydrogen contents in the  $COD_{B,i}$  (Equation 25, where  $Y = C/H$  or  $N$ ). To calculate the elements fractions in the VSS, the  $f_{C/H/N}$  in the TSS and in the ISS were determined using the elemental analysis of the suspended solids and the ash (CHONS method). However, the oxygen fraction cannot be calculated by this elemental analysis because the water content in the TSS and ISS samples are negligible. For this reason, the  $f_{O(COD_{B,i})}$  was calculated using the previous equations 22 and 23 where the phosphorous fraction ( $f_{P(COD_{B,i})}$ ) was estimated by iteration to achieve the 1.000 as the results of the equation 23.

$$(25) \quad f_{Y(\text{COD}_{B,i})} = \frac{f_{CV(\text{COD}_{B,i})} [\text{VSS } f_{Y(\text{VSS})} - X_I f_{Y(X_I)}]}{\text{COD}_{B,i}}$$

$$\text{where } f_{Y(\text{VSS})} = \frac{\text{TSS } f_{Y(\text{TSS})} - \text{ISS } f_{Y(\text{ISS})}}{\text{VSS}}$$

The element fractions determination allowed the expression of the  $\text{COD}_{B,i}$  as an overall molecular formula of the type  $\text{C}_x\text{H}_y\text{O}_z\text{N}_a\text{P}_b$ , with  $x = f_{C(\text{COD}_{B,i})}/12$ ,  $y = f_{H(\text{COD}_{B,i})}/1$ ,  $z = f_{O(\text{COD}_{B,i})}/16$ ,  $a = f_{N(\text{COD}_{B,i})}/14$  and  $b = f_{P(\text{COD}_{B,i})}/31$ , and all normalized by  $x = 1$ .

To summarize, the parameters determined to know the COD fractionation and overall molecular formula of  $\text{COD}_{B,i}$ , sampling points and frequency are showed in the following table (Table 8).

**Table 8.** Parameters determined for the  $f_{\text{upi}}$  and overall molecular formula of  $\text{COD}_B$  definition in each condition.

Parameter	Symbol	Matrix	Frequency
<b>Anaerobic biodegradability test</b>			
Total solids	TS	Inoculum	Beginning
Inorganic solids	IS	Inoculum	Beginning
Influent total COD	$\text{COD}_{T,i}$	Vessel	Beginning
Influent soluble COD	$\text{COD}_{S,i}$	Vessel	Beginning
Effluent total COD	$\text{COD}_{T,e}$	Vessel	After 25 days
Effluent soluble COD	$S_I$	Vessel	After 25 days
Biogas production	$Q_B$	Gas phase	Every day
Methane concentration	$\text{CH}_4$	Gas phase	Day 10
Volatile fatty acids concentration	VFA	Vessel	Each 3 days
VFA composition	$\text{VFA}_{\text{COMP}}$	Vessel	Day 10
Hydrogen ions concentration	pH	Vessel	Each 3 days
<b>Overall molecular formula</b>			
Total suspended solids	$\text{TSS}_i$	Influent	Beginning
Volatile suspended solids	$\text{VSS}_i$	Influent	Beginning
CHONS in TSS	-	Influent	Beginning
CHONS in ISS	-	Influent	Beginning

### 3.4.2. Evaluation of cosubstrate mixtures in the AcD process

In the beginning of the lab-scale assay, the AcD process was carried out using the initial mixture composed by CM, DFR and GW (EFF, Figure 20). After the steady state condition was achieved, the GLY was added in the influent fraction at 5 and 10 % of the influent TS instead of the same amount of TS in the EFF to keep the same solids behaviour of the system according with previous reports (Castrillón, Fernández-Nava et al. 2013, Timmerman, Schuman et al. 2015). The steady state conditions after the addition of any cosubstrate in the AcD is determined using the ratio between the VFA concentration and the Alk (Ferrer,



Vázquez et al. 2010) or the ratio between the intermediate Alk and the total Alk (Astals, Nolla-Ardèvol et al. 2012). However, in the present work the VFA/Alk was used to determine this stability (Ferrer, Vázquez et al. 2010, Timmerman, Schuman et al. 2015).

The optimal mixture of EFF and GLY was set by the increment or the decline of the biogas volume produced ( $Q_B$ ) in the AcD after achieve the steady state condition in each influent mixture. The  $Q_B$  was measured every day of the assay and the biogas production rates were determined for these particular conditions. Additionally, the pH, Alk, VFA, TAc,  $COD_{T,i}$  and the  $COD_{T,e}$  were measured to determined the steady state conditions and the behaviour of the system (Astals, Nolla-Ardèvol et al. 2012).

The biogas and the VFA compositions were determined using GC to calculate and correlate with the COD contents in both. These were measured only for the optimal condition and used in the entire assay to simplify the analytical determinations.

To summarize, the parameters determined for the cosubstrate mixture evaluation, sampling points and frequency are shown in the following table (Table 9).

**Table 9.** Parameters determined for the evaluation of the cosubstrate mixtures.

Parameter	Symbol	Matrix	Sampling point	Frequency
Biogas production	$Q_B$	Gas phase	8	Every day
Methane concentration	$CH_4$	Gas phase	8	Day 97
Hydrogen ions concentration	pH	Reactor flow	2	Every day
Volatile fatty acids concentration	VFA	Reactor flow	3	Each 3 days
Volatile fatty acids composition	$VFA_{COMP}$	Reactor flow	3	Day 95
Alkalinity	Alk	Reactor flow	3	Each 3 days
Total acidity	TAc	Reactor flow	3	Each 3 days
Influent total COD	$COD_{T,i}$	Reactor flow	1	Each 3 days
Effluent total COD	$COD_{T,e}$	Reactor flow	3	Each 3 days

### 3.4.3. Biogas production rates

The biogas production rates were calculated by the ratio between the  $Q_B$  produced ( $L_{biogas}/d$ ) and the influent concentration of the VS or COD. These rates were evaluated for each step of the lab-scale assay and using the three measures of the parameters involved. These triplicate allowed the propagation of the errors to compare the results. In conclusion, the parameters measured for the evaluation of the biogas production rates, sampling points and frequency are presented below (Table 10).

**Table 10.** Parameters determined for the biogas production rates calculations.

Parameter	Symbol	Matrix	Sampling point	Frequency
Biogas volume	$Q_B$	Gas phase	8	Steady state
Influent total COD	$COD_{T,i}$	Reactor flow	1	Steady state
Influent VS	$VS_i$	Reactor flow	1	Steady state

### 3.4.4. Stoichiometric and mass balance of the AcD process

The mass balances were done to check the biological process involved in the anaerobic conditions for the EFF and GLY10+R conditions. While the COD mass balances were based in the direct measurement of the influent and effluent COD concentration and the methane production, the N and P balances were done using the stoichiometric of the reaction. The mass balances of the AcD process were defined according the control volume 1 (CV 1) and the 95 % of the concordance between the inlet and outlet flux were defined to confirm the mass conservation by the system (Figure 22).

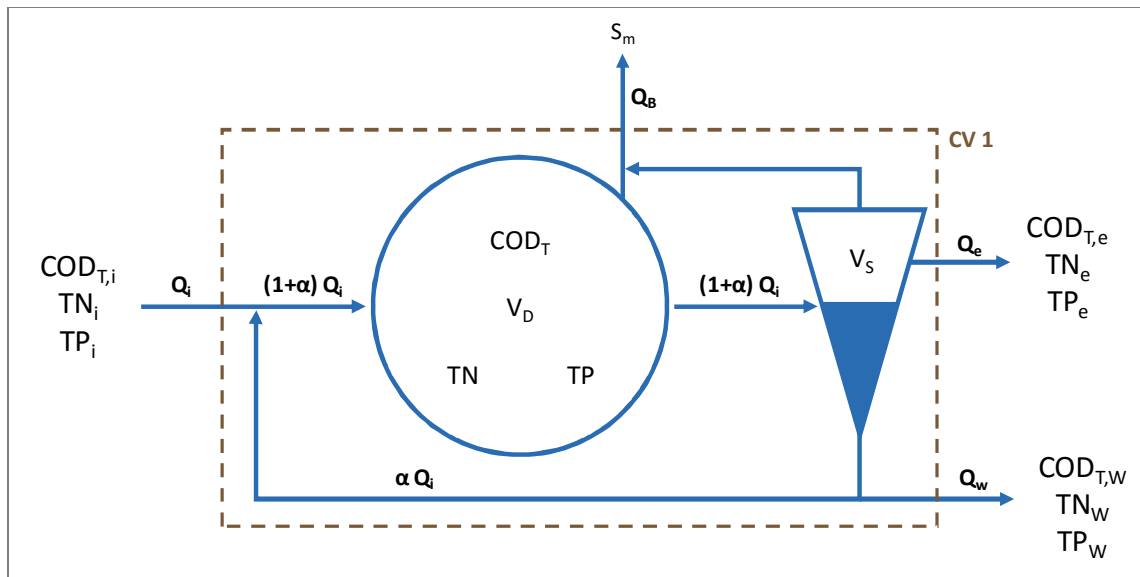

**Figure 22.** Schematic diagram of the anaerobic digestion process for the mass balances.

The COD mass balance was calculated from the following equations where the  $COD_{T,i}$ ,  $COD_{T,e}$  and the flows were measured directly (Equations 26 to 28). Additionally, the COD content in the biogas ( $S_m$ ) was defined by the determination of the methane concentration by GC in the day 97 of the lab-scale assay. On the other hand, the overall biomass yield ( $E$ ) was estimated based in the specific yields of the acidogenic and methanogenic microorganisms by the AB test (Equation 14).

$$(26) \quad COD_{IN} = COD_{OUT}$$

$$(27) \quad COD_{IN} = Q_i COD_{T,i}$$

$$(28) \quad COD_{OUT} = Q_e COD_{T,e} + Q_w COD_{T,w} + Q_B S_m + E COD_{T,i}$$

Based in the overall molecular formula of the  $COD_{B,i}$  ( $C_xH_yO_zN_aP_b$ ) and the  $C_kH_lO_mN_nP_q$  as the overall molecular formula of the biomass produced, the anaerobic digestion reaction can be expressed by the following chemical reaction according with the electron transfer in the system (Ekama 2015) (Equation 29).

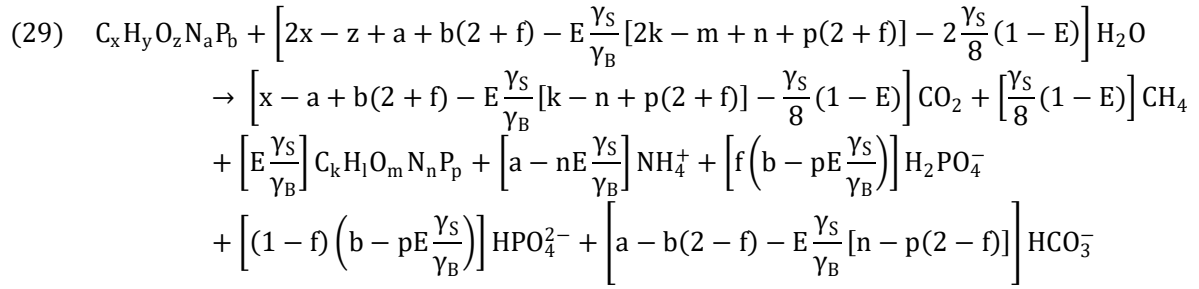

Where:

- x, y, z, a and b are the coefficients, based in x = 1, of the overall molecular formula of the COD<sub>B,i</sub>. Determined in section 4.1.1.
- k, l, m, n and p are the coefficients, based in k = 1, of the overall molecular formula of the anaerobic biomass. (Rittman and McCarty 2001)
- E is the overall biomass yield for the AcD process. Determined in section 4.1.1.
- $\gamma_S$  is the electron donating capacity per mole of organic substrate and it is given by  $\gamma_S = 4x + y - 2z - 3a + 5b$  (in e<sup>-</sup>/mol). The COD content in a mol of the substrate is given by COD =  $\gamma_S \times 8$  gCOD/e<sup>-</sup> (in gCOD/mol).
- $\gamma_B$  is the electron donating capacity per mole of anaerobic biomass and it is given by  $\gamma_B = 4k + l - 2m - 3n + 5p$  (in e<sup>-</sup>/mol). The COD content in a mol of the anaerobic biomass is given by COD =  $\gamma_B \times 8$  gCOD/e<sup>-</sup>. (in gCOD/mol).
- f is the fraction of the H<sub>2</sub>PO<sub>4</sub><sup>-</sup> in the total PO<sub>4</sub><sup>3-</sup> and it is given by the pH.

The consumption or production of each component in the steady state condition can be calculated and checked with the experimental data. Firstly, the moles of COD consumed ( $\Delta COD_B$ ) were determined considering the COD<sub>B,i</sub> and the remainder biodegradable COD (COD<sub>B</sub>) (Equation 30). This remainder COD was calculated based the COD<sub>B</sub> mass balances in the CV1 and considering the reported unbiodegradable endogenous residues of anaerobic sludge ( $f_{AD}$ ), the E and the  $f_{upi}$  previously determined (Appendix B, Equation 31)

$$(30) \quad \Delta COD_B = \frac{COD_{B,i} - COD_B}{8\gamma_S} = \frac{Q_i COD_{T,i} (1 - f_{upi}) - COD_B}{8\gamma_S}$$

$$(31) \quad COD_B = \frac{1}{(1 - E)} \left\{ Q_i COD_{T,i} [(1 - f_{upi}) + 1] - Q_e COD_{S,e} \right\}$$

$$- Q_e (COD_{T,e} - COD_{S,e}) (1 - f_{AD}) + Q_W COD_{T,W} (1 - f_{AD})$$

Consequently, from the chemical equation 29, the  $\Delta COD_B$  and the E, the production of CH<sub>4</sub> (gCOD/d), biomass (gCOD/d), NH<sub>4</sub><sup>+</sup> (gN/d), PO<sub>4</sub><sup>3-</sup> (gP/d) and bicarbonate as Alk (gCaCO<sub>3</sub>/d) were calculated. These results were checked with the experimental data measured before and after the anaerobic process (Equations 32 to 37).

$$(32) \quad S_m = 64(\text{gCOD/mol}) \frac{Y_S}{8} (1 - E) \Delta COD_B$$

$$(33) \quad COD_{BIO_M} = 8\gamma_B(\text{gCOD/mol}) \frac{Y_S}{Y_B} E \Delta COD_B$$

$$(34) \quad \text{NH}_4^+ = 14(\text{gN/mol}) \left( a - n \frac{Y_S}{Y_B} E \right) \Delta \text{COD}_B$$

$$(35) \quad \text{H}_2\text{PO}_4^- + \text{HPO}_4^{2-} = 31(\text{gP/mol}) \left( b - p \frac{Y_S}{Y_B} E \right) \Delta \text{COD}_B$$

$$(36) \quad \text{HCO}_3^- = 50(\text{gCaCO}_3/\text{mol}) \left[ a - b(2 - f) - E \frac{Y_S}{Y_B} [n - p(2 - f)] \right] \Delta \text{COD}_B$$

$$(37) \quad \text{CO}_2 = \left[ x - a + b(2 + f) - E \frac{Y_S}{Y_B} [k - n + p(2 + f)] - \frac{Y_S}{8} (1 - E) \right] \Delta \text{COD}_B$$

The effluent Alk was given by the sum of the  $\text{Alk}_i$  and the Alk produced in the AcD process (Equation 36). Moreover, after calculate the moles of  $\text{CH}_4$  and  $\text{CO}_2$  (mol/d), the concentration of each gas in the biogas was checked by partial pressure of  $\text{CH}_4$  (Equation 38).

$$(38) \quad p\text{CH}_4 = \frac{\text{mol CH}_4}{\text{mol CO}_2 + \text{mol CH}_4} = \frac{(S_m/64)}{\text{mol CO}_2 + (S_m/64)}$$

In order to summarize, the parameters determined for the mass balances and the stoichiometry evaluation of the AcD process, sampling points and frequency are showed in the following table (Table 11).

**Table 11.** Parameters determined for the mass balances checks.

Parameter	Symbol	Matrix	Sampling point	Frequency
Biogas production	$Q_B$	Gas phase	8	Every day
Methane concentration	$\text{CH}_4$	Gas phase	8	Day 97
Influent flow	$Q_i$	Reactor flow	1	Steady state
Effluent flow	$Q_e$	Reactor flow	3	Steady state
Sludge waste flow	$Q_w$	Reactor flow	4	Steady state
Influent total COD	$\text{COD}_{T,i}$	Reactor flow	1	Each 3 days
Effluent total COD	$\text{COD}_{T,e}$	Reactor flow	3	Each 3 days
Sludge total COD	$\text{COD}_{T,w}$	Reactor flow	4	Steady state
Influent alkalinity	$\text{Alk}_i$	Reactor flow	1	Steady state
Effluent alkalinity	$\text{Alk}_e$	Reactor flow	3	Steady state
Sludge alkalinity	$\text{Alk}_w$	Reactor flow	4	Steady state
Influent free and saline ammonium	$\text{NH}_4^+_{,i}$	Reactor flow	1	Steady state
Effluent free and saline ammonium	$\text{NH}_4^+_{,e}$	Reactor flow	3	Steady state
Sludge free and saline ammonium	$\text{NH}_4^+_{,w}$	Reactor flow	4	Steady state
Influent orthophosphate	$\text{PO}_4^{3-}_{,i}$	Reactor flow	1	Steady state
Effluent orthophosphate	$\text{PO}_4^{3-}_{,e}$	Reactor flow	3	Steady state
Sludge orthophosphate	$\text{PO}_4^{3-}_{,w}$	Reactor flow	4	Steady state

### 3.4.5. Kinetic evaluation of the hydrolysis/acidogenic processes

The first and the kinetic limiting step in the AcD process are the hydrolysis and the acidogenic processes of the  $X_S$  (Figure 16) (Pavlostathis and Giraldo-Gomez 1991). In the present work, the  $COD_B$  was considered all as  $X_S$  in order to simplify the kinetics calculation. The hydrolysis of the  $COD_{B,i}$  can be predicted by four different approaches (Söttemann, Ristow et al. 2005) (Ikumi, Harding et al. 2014):

- 1<sup>ST</sup> order with respect to the  $COD_B$
- 1<sup>ST</sup> order specific with respect to the  $COD_B$  and the acidogen biomass concentration ( $Z_{AD}$ ) which mediates the process
- Monod kinetics
- Saturation (or Contois) kinetics

However, in this work the Monod kinetics and the 1<sup>ST</sup> order specific was used to predict the behaviour of the hydrolysis/acidogenic processes in the initial and the final conditions (EFF and GLY10+R respectively). The influent concentration of the  $Z_{AD}$  ( $Z_{AD,i}$ ) was assumed as negligible, although the cow manure presents the anaerobic biological processes inside of the rumen. So the reactor had a continuous inoculum of  $Z_{AD}$  that must be considered. The steady state mass balances of  $Z_{AD}$ ,  $COD_B$  and  $S_m$  in the CV 1 were presented in the appendix and summarized in the following table (Figure 22, Table 12 and Appendix B).

The  $COD_B$  defined by the kinetics equations were compared with the experimental  $COD_B$  measured and determined by Equation 31. Additionally, the theoretical  $S_m$  (Equations 54 and 55) were estimated using the  $Z_{AD}$  (Equation 50) and the  $COD_B$  (Equations 51 and 52) calculated previously. These  $S_m$  were compared with the experimental data obtained from the lab-scale assay in the steady state conditions of the EFF and GLY10+R steps. These comparisons allowed to determine the fit of these theoretical kinetics models with the experimental data.

**Table 12.** Steady state equations of AcD kinetics based in Monod and 1<sup>ST</sup> order specific equations. (a). Kinetics constants at 35° based in Pavlostathis *et. al.*, Henry's constant at 25°C based in Sander *et. al.* (Pavlostathis and Giraldo-Gomez 1991, Sander 1999) . (b) Experimental data obtained from the section 4.1.1..

Parameter	Kinetics equations	
	Monod	1 <sup>ST</sup> order specific
Hydrolysis rate (gCOD/L.d)	(39) $r_H = \frac{\mu_m COD_B}{K_S + COD_B} Z_{AD}$	(40) $r_H = K_H COD_B Z_{AD}$
Residual biodegradable COD (gCOD/L)	(51) $COD_B = \frac{K_S \left( b_{AD} + \frac{1}{HRT} \right)}{\mu_m Y_{AD} - \left( b_{AD} + \frac{1}{HRT} \right)}$	(52) $COD_B = \frac{1}{Y_{AD} K_H} \left( b_{AD} + \frac{1}{HRT} \right)$
Methane production (gCOD/d)	(54) $S_m = \frac{V_T (1 - E) (1 + H_{cc})}{Q_e} \frac{\mu_m COD_B}{(K_S + COD_B)}$	(55) $S_m = \frac{V_T (1 - E) (1 + H_{cc})}{Q_e} K_H COD_B Z_{AD}$

Parameter	Kinetics equations	
	Monod	1 <sup>ST</sup> order specific
Acidogenic biomass (gCOD/d)	(50)	$Z_{AD} = \frac{Y_{AD} [Q_i (1 - f_{upi}) COD_{T,i} - Q_e COD_{S,e} - COD_B]}{HRT [b_{AD} - Y_{AD} b_{AD} (1 - f_{AD}) + \frac{1}{HRT}]}$
Kinetic constants reported <sup>(a)</sup>		$\mu_m = 0.06 \text{ d}^{-1}$ . $K_s = 200 \text{ mgCOD/L}$ . $K_H = 0.322 \text{ L/gCOD.d}$ . $b_{AD} = 0.04 \text{ d}^{-1}$ . $H_{cc} = 31.4$ .
Kinetic constants from experimental data <sup>(b)</sup>		$Y_{AD} = 0.061 \text{ gCOD/gCOD (EFF)}$ and $Y_{AD} = 0.091 \text{ gCOD/gCOD (GLY10+R)}$ . $E = 0.068 \text{ gCOD/gCOD (EFF)}$ and $E = 0.101 \text{ gCOD/gCOD (GLY10+R)}$ . $f_{AD} = 0.8$ .

### 3.5. Asses the performance of the secondary and tertiary treatment

#### 3.5.1. Nitrogen behaviour in the secondary and tertiary treatment

The N-behaviour of the secondary and the tertiary treatment were evaluated by the direct measurement of the concentrations of TKN,  $\text{NH}_4^+$ ,  $\text{NO}_3^-$  and  $\text{NO}_2^-$  and the calculation of the TN. The TN concentrations were estimated by the sum between the TKN,  $\text{NO}_3^-$  and  $\text{NO}_2^-$ . These evaluations were done for the initial and final operation conditions of the lab-scale system (EFF and GLY10+R). The concentrations of each component were measured three times in the sampling points of the water line in the steady state conditions (Figure 19, points 1, 3, 5, 6 and 7). To conclude, the parameters determined for the nitrogen behaviour evaluation, sampling points and frequency are showed in the following table (Table 13).

**Table 13.** Parameters determined for the nitrogen evaluation.

Parameter	Symbol	Matrix	Sampling point	Frequency
Free and saline ammonium concentration	$\text{NH}_4^+$	Reactor flow	1, 3, 5, 6 and 7	Steady state
Nitrate concentration	$\text{NO}_3^-$	Reactor flow	1, 3, 5, 6 and 7	Steady state
Nitrite concentration	$\text{NO}_2^-$	Reactor flow	1, 3, 5, 6 and 7	Steady state
Total Kjeldahl Nitrogen concentration	TKN	Reactor flow	1, 3, 5, 6 and 7	Steady state

#### 3.5.2. Removal efficiency study in the wastewater treatment system

The removal efficiencies of the COD, TSS, TN, TP and FC were determined for each component of the assay; the anaerobic reactor, the stone filters, the pond and the overall of the valorization system. The flux (Kg/d) was considered in the efficiency calculations as the product between the flow and the concentration (Equation 56). While the COD, VSS, TN and TP removal efficiency were determined in each steady state condition, the FC removal efficiency was calculated only for the final condition (GLY10+R).

$$(56) \text{ Removal efficiency} = \left( \frac{Q_{IN} \text{CONC}_{IN} - Q_{OUT} \text{CONC}_{OUT}}{Q_{IN} \text{CONC}_{IN}} \right) 100 \quad (\text{in } \%)$$

The concentrations of each component were measured three times in the sampling points of the water line in the steady state conditions (Figure 19, points 1, 3, 5, 6 and 7). These triplicate allowed the propagation of the errors to compare the results. To conclude, the parameters determined for the N-behaviour evaluation, sampling points and frequency are showed in the following table (Table 14).

**Table 14.** Parameters determined for the removal efficiency evaluation.

Parameter	Symbol	Matrix	Sampling point	Frequency
Total COD	COD <sub>T</sub>	Reactor flow	1, 3, 5, 6 and 7	Steady state
Volatile suspended solids	VSS	Reactor flow	1, 3, 5, 6 and 7	Steady state
Nitrate concentration	NO <sub>3</sub> <sup>-</sup>	Reactor flow	1, 3, 5, 6 and 7	Steady state
Nitrite concentration	NO <sub>2</sub> <sup>-</sup>	Reactor flow	1, 3, 5, 6 and 7	Steady state
Total Kjeldahl Nitrogen concentration	TKN	Reactor flow	1, 3, 5, 6 and 7	Steady state
Total phosphorous concentration	TP	Reactor flow	1, 3, 5, 6 and 7	Steady state
Faecal coliforms	FC	Reactor flow	1, 3, 5, 6 and 7	GLY10+R

## 3.6. Full-scale valorization system design

### 3.6.1. Process flow diagram

The ERB farm was chosen to design the full-scale system since it had an irrigation system installed and the farmers were willing to collaborate with this project. The capacity of the system was designed to considered the treatment of the effluent produced by 250 milking cows in the milking and feeding processes, although 180 milking cows constitute the actual size of the farm (70 cows will be incorporated in a the near future). The valorization system plan was composed by low-cost treatment processes and in agreement with the economical capacity of the small and medium-farms in Uruguay. Additionally, the effluents of the system must achieve the irrigation standards without restrictions. The primary approach is presented in the figure below (Figure 23).

The results obtained from the previous sections (lab-scale experiments), were the inputs used for the design. The valorization system is composed by: a coarse screen and grit removal (primary treatment), a high-rate anaerobic reactor provided with a settler and a macrofiltration system where the sludge is dried (secondary treatment), and two horizontal subsurface flow constructed wetlands, as stone filters, and a pond (tertiary treatment). Moreover, the designed system includes processes to clean and use the produced biogas. Consequently, the process flow diagram was done to explain the preliminary design.

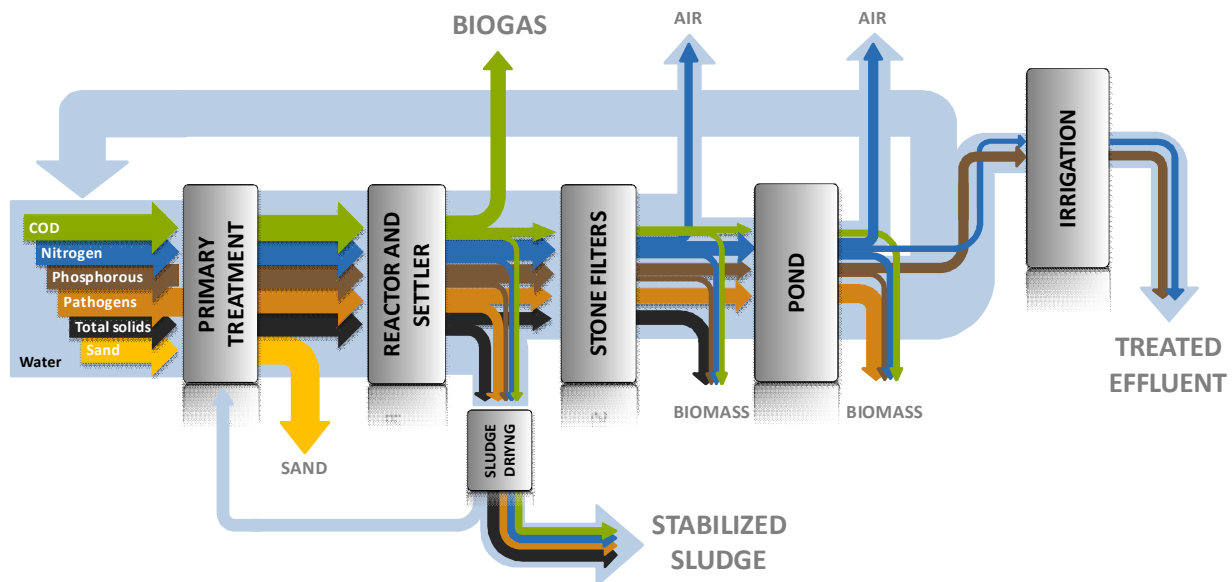

**Figure 23.** Nutrients removal and water recycle in the designed valorization process.

### 3.6.2. Preliminary design

This design is based in the daily waste production from the ERB farm. An average of the stormwater and wastewater are considered to catch, with a recover fraction of 0.9. The final effluent would have an approximately load of 740.5 KgTS/d, because 3.2 m<sup>3</sup>/d of the stormwater and 62.6 m<sup>3</sup>/d of the wastewater would be produced (12.4 KgTS/m<sup>3</sup> in the influent mixture).

#### Primary treatment

The first step in the valorization system would be the primary treatment, which aims to remove the heavy materials that compose the effluent (as woods, stones and sand). The accumulation of this unbiodegradable material into the reactor would reduce the effective volume for the biological process and the equipment could be damaged. For this purpose a course screen, with 1 cm of separation between bars, and the grit chamber were designed (Figure 24). These primary treatment systems are amply distributed in the wastewater treatment processes. The grit removal is based in the differences of the sedimentation velocity between the heavy materials and the organic matter. The length:height (L/H) relation of the camber chosen is 15:1 to ensure the horizontal a vertical proper velocities (0.02 m/s and 0.3 m/s respectively). Based in rules of thumbs, 30 s of HRT must be applied. Additionally, the range between 600 and 1000 m<sup>3</sup>/m<sup>2</sup>.d was defined as the Surface Hydraulic Loading Rate (HLR<sub>S</sub>).



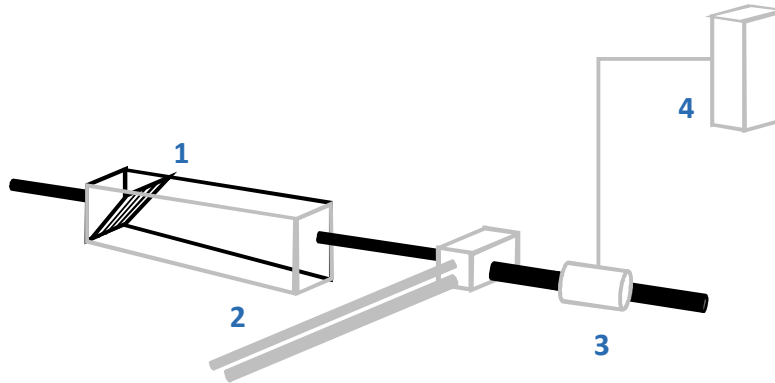

**Figure 24.** Primary treatment. 1. Coarse screen. 2. Grit chamber. 3. Heat exchanger. 4. CHP.

Furthermore, an extra chamber and a heat exchanger also compose the primary treatment design. The chamber should mix the flows from the sludge and scum recycles and the runoff from the sludge drying system. The aim of the heat exchanger is to heat externally the anaerobic reactor at 30 °C to impulse the biochemical activity. A part of the biogas produced would be used to heat the volume inside the reactor by a boiler (382 KWh/d in winter and 164 KWh/d in summer, 295 KWh/d averaged). Additionally, this component could provide a heat treatment to the inlet mixture and the unbiodegradable flow from the scum recycle (thermal shock at 60-70 °C). This physical treatment aims to improve the biodegradability of the scum formed, which should be composed by a big proportion of lignocellulosic matter (Viñas and Gutiérrez 2004). The agitation and heating by the scum and the anaerobic sludge recycles, allows using external equipments to decrease the maintenance costs.

### Anaerobic reactor

The anaerobic reactor design is based in a combination of the best characteristics of the ACP reactor, and the lagoon reactors (Lo, Chen et al. 1986, Tauseef, Abbasi et al. 2013). Additionally, the settler is incorporated in the same system to reduce the investment cost and to catch the biogas produced in it. This design aims to work with a high SRT and low HRT, and to incorporate the gasholder join with the reactor. The idea is to use the best characteristics of these typical reactors and to adapt a solution for the local conditions of the farm (environmental, economical, climatic and operative conditions).

A high-rate process could be achieved by the biomass recycle. High values of SRT were considered to ensure the hydrolysis of the organic polymers (50 d), hence the contact time between the organic matter and the microorganisms should be achieved (Figure 25). Additionally, the high SRT allows reducing the effects of toxic compounds in the AcD process, due to the toxicity is diluted by the high biomass concentration.

The reactor is designed as an anaerobic covered pond, to decrease the heat losses, with a flexible membrane as gas holder. The Etilen-Propilen Dien Monomers (EPDM) is selected as the material for the gas reservoir. This material allows storing variable quantities of biogas produced during the day into the reactor without the requirement of an external gas holder. Consequently, the energy could be produced in the hours where the energy price is higher.

As was mentioned above, the effluent of the farm had big amount of fibres and unbiodegradable particulate solids (Viñas and Gutiérrez 2004, Perez-Gavilan and Viniegra 2008). Generally, these fibres float in water solutions producing an unbiodegradable scum and difficult the operation of the reactors, as was reported and showed in the present work (Souza, Silva et al. 2006, Rosa, Lobato et al. 2012) (Appendix A). The chosen method

to remove the scum is to generate an overflow inside of the reactor to pump it, after to feed the valorization system (Figure 25).

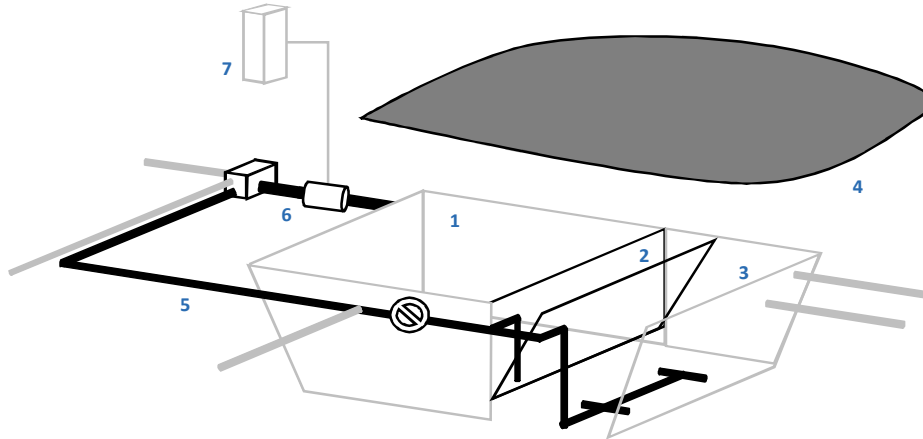

**Figure 25.** Anaerobic reactor system. 1. Anaerobic pond zone. 2. Scum reservoir. 3. Settler zone. 4. Flexible membrane. 5. Recycle of the anaerobic biomass and scum. 6. Heat exchanger. 7. CHP.

In summary, the reactor design aims to solve actual problems that are found in the application of the low-cost anaerobic reactors, as: low removal efficiency and biogas production rates, big footprint of the reactors, biogas release to the atmosphere in the sedimentation process, requirement for an external gas holder and high O&M costs. This design for the anaerobic reactor followed the parameters presented below (Table 15).

**Table 15.** Design parameters for the anaerobic reactor.

Parameter	Symbol	Used design value	Observation	Reference
Sludge retention time	SRT	60 d	Hydrolysis kinetics	(Ekama 2015)
Total hydraulic retention time	$HRT_{D+S}$	3-10 d	Anaerobic process	Rule of thumb
SRT/HRT	-	10-100 -	ACP	Rule of thumb
Total solids concentration	$TS_D$	25 $KgTS/m^3$	ACP	Rule of thumb
		2-3	Anaerobic pond	(Moncayo 2013)
Organic loading rate	OLR	$KgCOD/m^3 \cdot d$	ACP	(Henze, van Loosdrecht et al. 2011)
		<10	ACP	
Volumetric organic loading rate	$OLR_V$	0.35 $KgBOD/m^3 \cdot d$	Anaerobic pond	(Van der Steen 2015)
Sludge organic loading rate	$OLR_S$	0.09 $KgCOD/KgVSS \cdot d$	ACP	(Van der Lier 2015)
Surface organic hydraulic loading rates	$OHLR_S$	100-200 $KgTS/m^2 \cdot d$	Thickener of the anaerobic sludge	(Salome 2015)

## Sludge dewatering

The stabilized sludge produced would be mainly composed by the biomass generated in the anaerobic process and the  $X_i$ . The recycle of this sludge and its extraction would allow for controlling the SRT in the system. This sludge should have a high humidity and content of pathogens, so it must be dried to remove these microorganisms and to use it as an organic fertilizer (Brisolara and Qi 2011). Drying and stabilization processes design is composed by the flocculation of the sludge, using organic polyelectrolytes; and the filtration of these flocs generated by the macrofiltration membrane. The permeated is reincorporated in the treatment process, and dried sludge is stabilized (Figure 26). Moreover, the dewatering process of the anaerobic sludge would require a small footprint, low weather dependence and reduced O&M costs. This process uses polymers and macrofiltration membranes to avoid the usage of drying sludge beds, thickeners and centrifuges for the stabilization. The Soiltain® dewatering tubes are chosen for this particular macrofiltration membrane. The dried and stabilized sludge confined inside the membrane will be used to reincorporate the nutrients of the soils. Based in the TSS content in the effluent of the reactor and in the sludge, and the mass of TSS inside the anaerobic pond zone defined the periodicity of the sludge purges. So, the  $\beta$ -factor would be the key parameter for the SRT control in the system.

The full-scale system must be efficient in pathogen removal by the dewatering system. Also the helminth ova and the FC concentrations must be checked. On the contrary, the addition of CaO as a flocculants and disinfectant, could be used to increment the pH and improve the pathogen concentrations (Pritchard, Penney et al. 2010, Brisolara and Qi 2011).

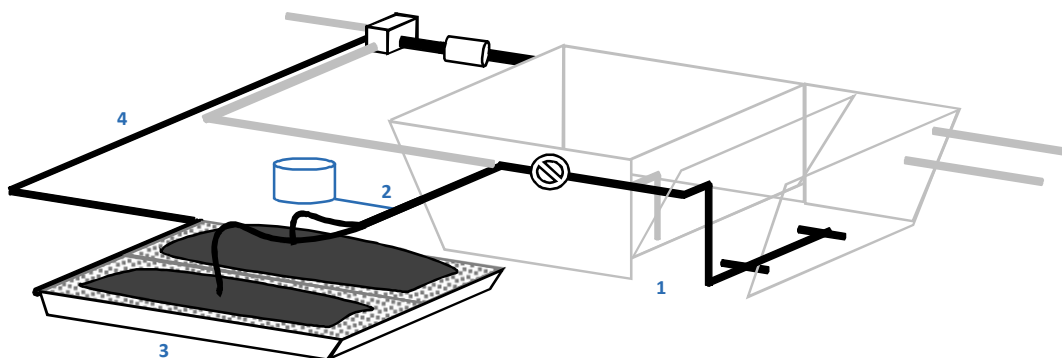
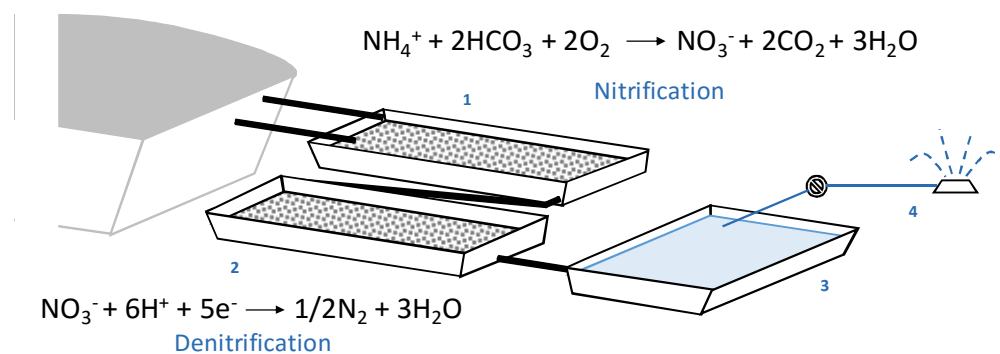

**Figure 26.** Scheme of the sludge drying process. 1. Extraction of the sludge from the settler. 2. Flocculants addition. 3. Macrofiltration process. 4. Permeated recycle.

## Constructed wetland

The incorporation of the two constructed wetlands with a subsurface horizontal flow searched to extrapolate the lab-scale results for N and solids removal to the full-scale system. While the TSS in the effluent of the anaerobic reactor was mainly removed for the filtration process by the stones (Liu, Zhao et al. 2015), the soluble N concentration was decreased by biochemical processes. For example, the nitrification of  $\text{NH}_4^+$  and the subsequent denitrification of the  $\text{NO}_3^-$  or  $\text{NO}_2^-$  were evidenced in the stone filters (N+D conditions). Consequently, a part of the N-compounds were released as  $\text{N}_2$  to the atmosphere (Tanner, D'Eugenio et al. 1999, Fisher and Acreman 2004, Saeed and Sun 2012, Liu, Zhao et al. 2015).

Though the system was designed based in the N+D process, different operation regimens could be applied to propel the nitrogen removal processes. Additionally, the operation of the constructed wetlands determines the microbiological community developed in the matrix and the metabolic capacity of the system (Saeed and Sun 2012). In this design, two constructed wetland in series after the anaerobic reactor are set to achieve this objective (Figure 27). The first one provided with an intermittent flow to generate the aerobic conditions, followed by the second one with a continuous influent flow to promote the anaerobic process. The HLR<sub>s</sub> defined for a subsurface constructed wetland is 0.3 m<sup>3</sup>/m<sup>2</sup>.d, based in the typical values suggested. Moreover, the relation between the length and width (L/B) chosen for each wetland is 8, because the increment in the distance of the flow inside the system improves the TSS removal efficiency.



**Figure 27.** Scheme of the constructed wetlands and pond design. 1. Intermittent feeding (nitrification). 2. Continuously feeding (denitrification). 3. Pond. 4. Irrigation process.

## Pond

As a strategy to remove pathogens, the maturation ponds have been amply developed in the local wastewater treatment process from dairy farms (Viñas and Gutiérrez 2004). Although the high pathogens removal efficiencies found in the lab-scale system is the main reason to design the pond, the N elimination also was aimed. Additionally, the pond is designed as a reservoir of water to the cleaning process and irrigation (Figure 27). However, the pathogen removal must be tested in the full-scale system to achieve the water quality needed for the usages. In the case that the pathogen removal does not allow the accordance with the standards, the TiO<sub>2</sub> could be used to accelerate the photocatalytic process to reduce the biological activity (Keane, McGuigan et al. 2014).

As was mentioned previously, the accumulation in the valorization system of the toxic compounds; as NH<sub>4</sub><sup>+</sup>, PO<sub>4</sub><sup>3-</sup> and S<sub>i</sub>, by the recycle flows could be reduced the biogas production. Therefore, the elimination of these toxic compounds should be discharged in a secure way. The farm where the valorization system is designed has an irrigation system already installed, allowing the irrigation of the effluent when is needed and the climatic conditions tolerate it. Consequently, the components that affect the productivity of the anaerobic process could be removed in order to fertilize of the crops. However, the recycle-irrigation rate must be defined as an important parameter in the full-scale valorization system.

Based in rules of thumbs, the HRT chosen was 3 d to ensure the working time of the rotifer predation (Decamp, Warren et al. 1999, Proakis 2003). Moreover, the length:with (L/B) ratio suggested was 1 to 3 for the maturation ponds. This technology has been tested for several

years in dairy farms effluent treatments, and actually in the lab-scale assay, but it can be improved with an increment of the solar activity by the reduction of the TSS in the previous steps and the activity of the rotifer found (in the settler and in the stone filters). For this reason, the surface area required for this pond was lower than the same system without the previous TSS removal process.

### Biogas line

The biogas produced and stored inside of the reactor would be used in the electric energy production by the combustion of the  $\text{CH}_4$  using the biogas powered electric generator. The process design aimed to produce the electricity in the high-cost period of the energy, this was based to cooperate with the provision in the rush hours and to get more profit from this sale. Previously, the biogas must be purified by the removal of the water vapour and the  $\text{H}_2\text{S}$  to extend the useful life of the generator incorporated and to decrease the health hazards. The cleaning process was also designed according to the incorporation of low-cost technologies by the development of homemade systems (Figure 28). The water vapour can be removed by the variation in the temperature and the volume of the biogas, producing the condensation of the water. This could be done considering a buried J-form gas pipe after the reactor. In the other hand, the  $\text{H}_2\text{S}$  in the biogas is a toxic and corrosive gas; hence it must be removed before use. A strategy applied is the oxidation of this gas to sulphuric acid ( $\text{H}_2\text{SO}_4$ ) by its filtration with a saturated matrix in ferric oxide ( $\text{Fe}_2\text{O}_3$ ) to remove the sulphur compounds from the gas phase.

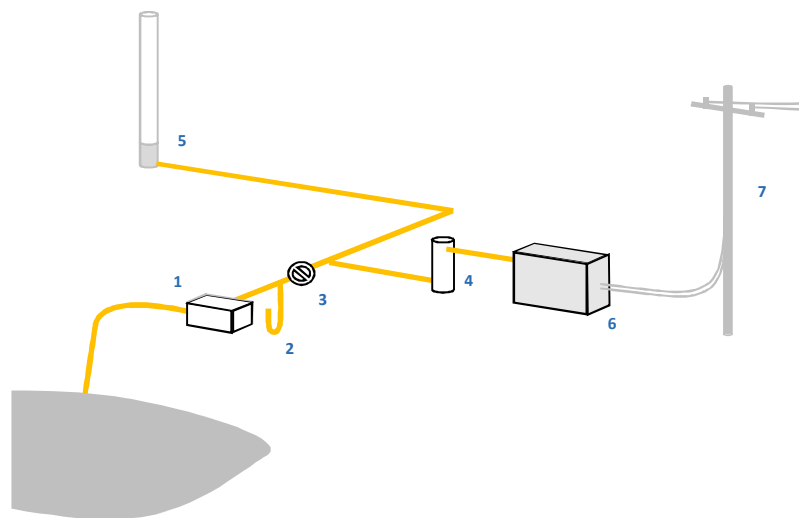
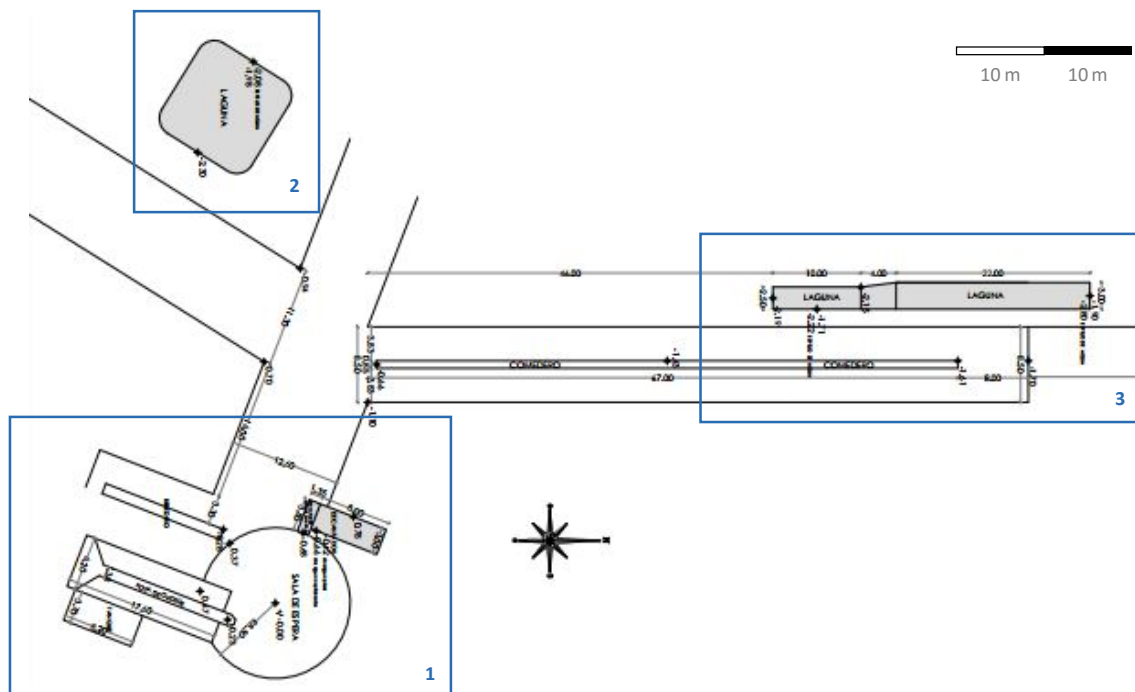

**Figure 28.** Biogas line. 1. Gas flow meter. 2. Dewatering tube. 3. Blower. 4. Filtration homemade system. 5. Security flame. 6. CHP generator, synchronous and calibration equipment (valves and manometers). 7. Low-voltage net of UTE.

The purified biogas would be burned in an electric generator of 40 kW. The gas system had several security equipments to decrease the risk in the biogas conduction and burn. For instance, a security flame to the maintenance periods and check valves are included in the design. The biogas pressure inside the gas holder cannot be higher than 20 mmHg, defined by the EPDM membranes; hence a blower for explosive gases must be installed to provide the proper biogas working pressure needed by the electric generator (40  $\text{m}^3/\text{h}$ , 40 mmHg).

### 3.6.3. Layout

The system design is done according to the topography of the ERB dairy farm. The terrain has a soft landscape, with a natural slope of 2.2 % approximately (Figure 29, from the zone 1 to the zone 3). The topography examination done by the architects Danreé and Torres-Pardo (DTP) and the lab-scale results suggested that the system must be built next to the feeding zone, where a pond was recently constructed (Figure 29, zone 3). Therefore, the previous excavations were used and the slope of the terrain can be harnessed to exploit the gravity as a motor force to move the flows. However, the hydraulic profile of the system must be determined to confirm the layout.



**Figure 29.** Initial topography evaluation of the ERB farm. 1. Milking process zone. 2. Current anaerobic pond. 3. Suggested place where the valorization system must be built.

## 3.7. Preliminary economical evaluation

The preliminary economical evaluation was carried out considering some assumptions in the investment cost of the full-scale system designed, the incomes produced by the system, and the O&M. Additionally, the balance sheet was done in United State Dollars (USD) and considering 7 years of the economical evaluation. The current dollar exchange rate considered was \$ 32/USD (Uruguayan pesos).

In contrast, the annual balances did not include other intangible variables as the solution of the effluent discharge problem (avoiding fines and penalties), the fiscal benefits, the improvement in the quality of life in the establishment (decreasing the vector and smell around) and the social aspects of the valorization system.

The preliminary economical evaluation was defined for three different scenarios, where the biogas production, water saving and consumables costs changed (EFF, GLY5+R and GLY10+R).

### 3.7.1. Balance sheet determination

#### Investment costs

The investment costs were determined from the full-scale design. This was composed by equipment, civil works, membranes, and by fees for architecture, design and automation. Additionally, the size of the full-scale system planned was the key factor in the determination of the investment required. The details of the investment cost were not presented because this determination are not in the scope of this work but the data was taken from the previous estimations, admitted grant in 2015 (Zinola 2015).

#### Incomes

The determination of the  $Q_B$  in the different operational conditions, as EFF, GLY5+R and GLY10+R; as well as the stabilized sludge and the water recovery were considered. The incomes were composed mainly by the electricity sales to UTE according with the Decree 173/2010 (Decreto 173/2010 2010). Additionally, the effluents recycle also was considered as incomes of the system because the water consumption by the farm decreased dramatically. Moreover, the stabilized sludge and the discharge flow (irrigation) were considered as nutrients saving by the farm due to the incorporation of the synthetics fertilizer will be decreased with the incorporation of the valorization system.

The biogas production by the AcD process was the key factor in the economical profitability. As a consequence, the GLY addition into the wastewater produced a significant increment in the incomes, although the consumable costs increase consequently by the purchase of the residue to the oily companies. In other hand, the electricity prices were considered in the rush hours because the biogas can be stored to produce this electricity in the high-cost period. These prices were USD 0.25/KWh, in 4 h/d and USD 0.11/KWh in 13 h/d (UTE 2016).

Another factor that affects the technological and economical feasibility was the pathogen removal in the anaerobic sludge and in the clarified effluent. The presence of faecal coliforms and helminth ova determine the employment of these by-products. World Health Organization (WHO) standards were used as reference in the land application of effluents in agriculture without limitation and published in 1989 (less than 1000 CFU/100mL or 100g and less than 1 helminth ova/L in the effluent or in the sludge) (WHO 1989). The local price of compost was used as the incomes produced by the dried anaerobic sludge; this was USD 300/ton. However, the nitrogen and phosphorous synthetic fertilizers (N-P-P-K) were used to define the nutrients saving by the effluent irrigation. The price of these fertilizers were in 2015, USD 408/ton of 46-0-0-0 (Urea) and USD 464/ton of 7-40-40-0, provided by the farmers.

The recycle conditions had the advantage that a big proportion of the water consumption by the farm in the cleaning process was decreased significantly. Thought the GW in Uruguay is free for the consumers, a price for these important saving was taken considering the environmental impact. The price of the GW considered the pump cost and the social impact of the extraction; this was USD 0.9/m<sup>3</sup> of GW (Khair, Mushtaq et al. 2012). However, this price do not reflex the reality of the country because the lack of water to drought events has an intangible costs for the farmers.

## O&M costs

The O&M costs were given by the electricity consumption, the monitoring costs, the consumables and the operational labour of the farmer. The electricity consumption was given by the hours that the sludge and water pumps were used; considering the low-cost energy hours operation (USD 0.05/KWh in 7 h/d). Additionally, the labour cost in the valorization system was estimated in 1 h/d to check the operational parameters principally. A typical hour cost for the dairy farm workers was evidenced as USD 6/h.

According with the consumables costs, the international price of the crude GLY (80 %) was considered, this volatile commodity had a price between USD 200-300/ton in 2012 but the higher value was taken (Quispe, Coronado et al. 2013). Moreover, the macrofiltration membrane price was USD 600/Unit and the numbers of membranes used in a year was defined by the operational SRT. The designed SRT of 50 d determined that 2 Soiltain® membranes of 5 m x 7 m (perimeter and large respectively) must be used in a year. This dewatering system of the sludge, also consumed polyelectrolytes in a ratio of 0.2 g/Kg (USD 8.9/Kg). Additionally, the TiO<sub>2</sub> and/or CaO were considered if the pathogens concentration was not achieved.

### 3.7.2. Profitability evaluation

The life cycle of the valorization system was defined in a differenced way for each component. For instance, 15 years in the civil work and 5 years in the electric components, membranes and automation were considered. The payback period (PP), the internal return rate (IRR) and the net present value (NPV) were chosen to estimate the economical profitability of the system (Equation 57 to 59). The IRR was defined by 7 years and the return ratio for the NPV calculations was 0.10 (10 %).

$$(57) \quad PP = \frac{\text{Investment cost}}{(\text{Benefits} - \text{Costs})_t} \quad (\text{PP in years})$$

$$(58) \quad \sum_{t=0}^n \frac{(\text{Benefits} - \text{Costs})_t}{(1 + \text{IRR})^t} = \text{Investment cost} \quad (\text{IRR in \%})$$

$$(59) \quad \text{NPV} = \sum_{t=0}^n \frac{(\text{Benefits} - \text{Costs})_t}{(1 + r)_t} \quad (\text{NPV in USD})$$

Based in the results obtained in the lab-scale system, three different scenarios were defined, considering the EFF, GLY5+R and GLY10+R technological conditions. However, the future economical scenarios and social aspects must be considered to summarize the complete feasibility of the valorization system.



## CHAPTER 4

# Results and discussions

### 4.1. Evaluation of the behaviour of the AcD process

#### 4.1.1. Characterisation and determination of influent fractions.

##### Initial characterisation.

The following table shows the initial characterisation of the wastes produced by the dairy farm (CM and DFR) and the GLY used as cosubstrate for the AcD process (Table 16). The average value and the CI were calculated based in triplicate measures.

**Table 16.** Initial characterisation of the substrates used in the AcD process.

Parameter	Symbol	Units	CM	DFR	GLY
Total solids	TS	gTS/Kg	113.3 ± 6.6	735.0 ± 10.2	724.4 ± 46.6
Volatile solids	VS	gVS/Kg	91.2 ± 2.0	687.8 ± 21.5	644.4 ± 40.3
Total suspended solids	TSS	gTSS/Kg	87.8 ± 7.1	601.5 ± 28.6	1.9 ± 0.4
Volatile suspended solids	VSS	gVSS/Kg	81.8 ± 3.3	588.8 ± 20.8	1.7 ± 0.4
Total chemical oxygen demand	COD <sub>T</sub>	gCOD/Kg	93.9 ± 6.2	306.6 ± 20.5	1225 ± 203
Hydrogen ions	pH	-	7.04 ± 0.02	4.19 ± 0.04	4.18 ± 0.03
Free and saline ammonium	NH <sub>4</sub> <sup>+</sup>	mgN/Kg	75.7 ± 5.9	78.8 ± 9.7	
Nitrate	NO <sub>3</sub> <sup>-</sup>	mgN/Kg	76.8 ± 40.4	224.3 ± 50.6	
Nitrite	NO <sub>2</sub> <sup>-</sup>	mgN/Kg	6.29 ± 0.49	0.41 ± 0.17	
Total Kjeldahl nitrogen	TKN <sub>T</sub>	mgN/Kg	3291 ± 462	6675 ± 137	
Phosphate	PO <sub>4</sub> <sup>3-</sup>	mgP/Kg	154 ± 7	396 ± 99	
Total phosphorous	TP	mgP/Kg	424 ± 22	633 ± 156	
Faecal coliforms	FC	x 10 <sup>6</sup> CFU/Kg	2.0 ± 0.5		
Glycerol	Gly	g/Kg			723.1 ± 13.6
Methanol	Met	g/Kg			34.3 ± 1.4
Potassium	K <sup>+</sup>	g/Kg			36.0 ± 0.9

The TS concentration results of each component were used in the preparation of the influent mixtures to feed the valorisation system. In the initial condition were used 86 % of the influent TS from CM and 14 % from DFR (EFF mixture). On other hand, when the GLY was added as cosubstrate for the AcD process, a portion of the influent TS was changed instead of EFF mixture (5 or 10 % depends of the step) to keep the same solids behaviour in the system.

The acid pH values in the DFR (from acid-lactic fermentation) and the GLY samples suggested that the AcD process could have inhabitation problems due the low pH in the influent mixture.

### Unbiodegradable particulate fraction ( $f_{upi}$ ).

The first fractionation of the  $COD_{T,i}$  was done by the direct determination of the  $COD_{T,i}$  and the  $COD_{S,i}$  and the subsequent calculation of the  $COD_{X,i}$ . These determinations were measured for the initial condition (EFF) and the final condition (GLY10+R). After 25 days of the AB assay, the soluble COD was assumed as  $S_1$ . Thus the  $COD_{S,i}$  was fractionated in the  $S_s$  and the  $S_1$ . However, the  $COD_{X,i}$  fractionation needed the experimental determination of the  $f_{upi}$  by the AB test. The  $COD_{X,i}$  is composed by the  $X_1$  and the  $X_s$ , so the determination of this last one could be fractionate this part of the  $COD_{T,i}$  (Figure 21).

The AB test results are presented in the appendices chapter (Appendix C). Moreover, the determination of VFA concentration in meq/L by titration and the VFA composition defined by GC are presented below (Table 17). The  $CH_4$  concentrations in the biogas were determined by GC and also presented in the following table (Table 18). These measures allowed that the VFA and the  $CH_4$  production were expressed in gCOD/L. In addition, the  $S_m$ , the VFA concentration and the cumulative  $COD_{VFA}$  are presented in the following figure (Figure 30).

**Table 17.** VFA concentration determined by GC in the AB test.

Parameter	Units	EFF condition			GLY10+R condition		
		Acetic acid (C2)	Propionic acid (C3)	Butyric acid (C4)	Acetic acid (C2)	Propionic acid (C3)	Butyric acid (C4)
VFA concentration (at 248 h)	mg/L	13.6	7.3	16.0	128.5	43.4	56.7
	meq/L	0.226	0.099	0.182	2.140	0.586	0.644
Proportion in VFA	% of meq	44.7	19.5	35.8	63.5	17.4	19.1
Theoretical specific COD in $VFA_S$	gCOD/eq	64.0	112.0	160.0	64.0	112.0	16.0
Total COD in $VFA_S$	gCOD/eq		107.8			90.7	
Specific VFA concentration	mgCOD/L	14.5	11.0	29.1	137.0	65.6	103.0
Total VFA concentration	mgCOD/L		54.6			305.5	

**Table 18.** Methane concentration determined by GC in the AB test.

Parameter	Units	EFF	GLY10+R
Methane concentration (at 143 h)	nmol $CH_4$ /mL	23534 ± 3269	23787 ± 3154
Volume (T = 30 °C, P = 1 atm)	L/L <sub>biogas</sub>	0.588 ± 0.078	0.594 ± 0.091
Concentration	%	58.8 ± 7.8	59.4 ± 9.1
COD in biogas ( $S_m$ )	gCOD/L <sub>biogas</sub>	1.506 ± 0.209	1.522 ± 0.202

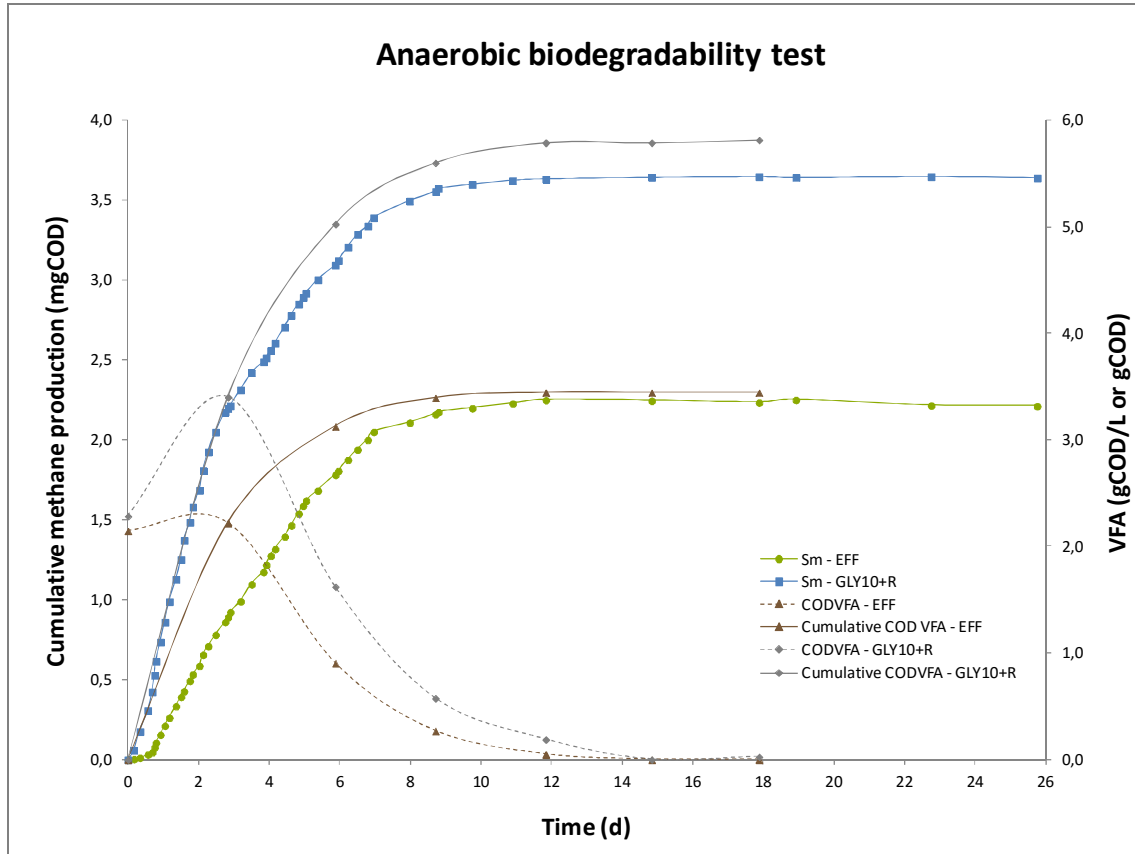

Figure 30. Anaerobic Biodegradability test results.

The VFA concentration in the reaction vessel increased in the first days of the assay (2 days) by the hydrolysis process, and decreased after that by its consumption by the methanogenic microorganisms. The GLY10+R condition had higher production of VFA than the EFF condition because the glycerol generated some acids by its degradation.

The  $S_m$  and the cumulative  $COD_{VFA}$  increased in the first days of the assay until the steady state conditions were achieved after 15 days. These components hold steady by 10 more days. So, the values obtained in the day 15 were considered in the  $f_{upi}$  calculations (Table 19).

Table 19. Calculation of  $f_{upi}$  from AB test.  $Y_{AD,R} = 0.15$  and  $Y_{MET,R} = 0.03$  (Pavlostathis and Giraldo-Gomez 1991).

Parameter	Symbol	Units	Equation	EFF	GLY10+R
Influent total COD	$COD_{T,i}$	gCOD/L	-	9.96	11.24
Influent soluble COD	$COD_{S,i}$	gCOD/L	-	2.90	4.62
Effluent soluble COD	$COD_{S,e}$	gCOD/L	-	0.84	0.74
Cumulative methane production	$S_m$	gCOD/L	-	2.25	3.64
Cumulative VFA production	$COD_{VFA}$	gCOD/L	-	3.45	5.79
Percentage of acidification	$\%A_t$	%	15	34.6	51.5
Percentage of methanogenization	$\%M_t$	%	16	22.6	32.4

Parameter	Symbol	Units	Equation	EFF	GLY10+R
Acidogenic biomass yield	$Y_{AD}$	%	17	6.1	9.1
Methanogenic biomass yield	$Y_{MET}$	%	18	0.7	1.0
Overall biomass yield	$E$	%	14	6.8	10.1
Biomass production	$COD_{BIOM}$	gCOD/L	14	0.68	1.01
Biodegradability	% $BD_T$	%	19	41.4	61.6
Unbiodegradable particulate fraction	$f_{upi}$	-	20	<b>0.50</b>	<b>0.32</b>

The  $S_m$  and  $COD_{VFA}$  produced in the GLY10+R were higher than the EFF condition because the  $f_{upi}$  for this last one was 0.50 instead of 0.32 in the case of GLY10+R condition. Thus, the biodegradability of the wastewater increased with the addition of GLY as cosubstrate rather than the CM and the DFR mixture. To summarize, the fractionation of the influent COD is presented in the following figure (Figure 31).

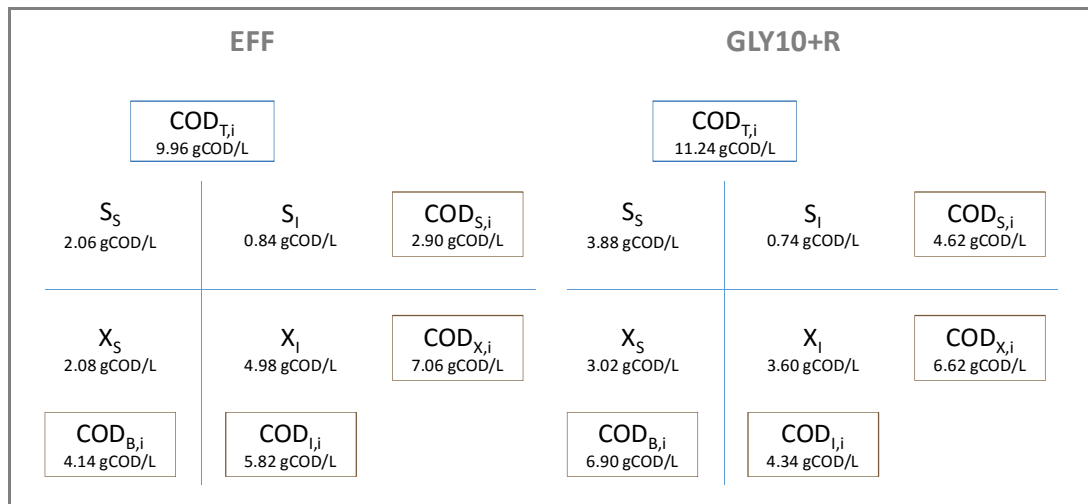

**Figure 31.** COD composition in the influent mixtures.

### Overall molecular formula.

The elements concentrations results determined for the TSS and the ISS by the CHONS analysis, in the initial and the final condition, are presented in the following table (Table 20). Using the mass concentrations and the methodology expressed in the 3.4.1. section, the elements fractions were the followings (Table 21).

**Table 20.** CHONS analysis results.

Sample	Units	Carbon	Hydrogen	Nitrogen
EFF - TSS	% w/w	27.1	3.7	6.7
EFF - ISS	% w/w	0.1	0.1	0.1
GLY10+R - TSS	% w/w	35.7	5.8	6.5
GLY10+R - ISS	% w/w	1.5	0.1	0.2

**Table 21.** Elements fraction calculations and overall molecular formula results.

Parameter	Units	Eq.	X <sub>i</sub>	EFF	GLY10+R	Molecular formula		
						EFF	GLY10+R	
f <sub>CV(COD<sub>B,i</sub>)</sub>	gCOD/gVSS	24	1.481	0.944	1.030			
f <sub>C(VSS)</sub>	gC/gVSS	25		0.308	0.426			
f <sub>C(COD<sub>B,i</sub>)</sub>	gC/gVSS	25	0.518	0.536	0.438	<b>1.000</b>	<b>1.000</b>	<b>x</b>
f <sub>H(VSS)</sub>	gH/gVSS	25		0.042	0.070			
f <sub>H(COD<sub>B,i</sub>)</sub>	gH/gVSS	25	0.066	0.074	0.077	<b>1.663</b>	<b>2.096</b>	<b>y</b>
f <sub>N(VSS)</sub>	gN/gVSS	25		0.076	0.078			
f <sub>N(COD<sub>B,i</sub>)</sub>	gN/gVSS	25	0.100	0.141	0.078	<b>0.225</b>	<b>0.153</b>	<b>a</b>
f <sub>O(COD<sub>B,i</sub>)</sub> by iteration	gO/gVSS	22 and 23	0.291	0.240	0.356	<b>0.336</b>	<b>0.609</b>	<b>z</b>
f <sub>P(COD<sub>B,i</sub>)</sub> by iteration	gP/gVSS	25 and 23	0.025	0.009	0.051	<b>0.007</b>	<b>0.045</b>	<b>p</b>
Sum of fractions	-	23	1.000	1.000	1.000			

Based in these results, the overall molecular formula of the type C<sub>x</sub>H<sub>y</sub>O<sub>z</sub>N<sub>a</sub>P<sub>b</sub> of the biodegradable influent COD for both conditions could be calculated and normalized by x = 1. These formulas were C<sub>1.000</sub>H<sub>1.663</sub>O<sub>0.336</sub>N<sub>0.225</sub>P<sub>0.007</sub> for the initial condition (EFF) and C<sub>1.000</sub>H<sub>2.096</sub>O<sub>0.609</sub>N<sub>0.153</sub>P<sub>0.045</sub> for the final condition (GLY10+R). The final condition had higher proportion of H and O in the COD<sub>B</sub> than the initial condition instead of N. This is because the glycerol contributes with carbon, hydrogen and oxygen (C<sub>3</sub>H<sub>8</sub>O<sub>3</sub>) to the influent mixture. As a consequence, the electron donating capacity of the EFF mixture was lower than the GLY10+R mixture for the same COD<sub>B,i</sub> concentration (γ<sub>S</sub> = 4.349 e<sup>-</sup>/mol and 4.645 e<sup>-</sup>/mol respectively). Furthermore, the GLY10+R mixture had higher proportion of P than the EFF condition. The accumulation of P by the recycle process could be an important factor to be considered in the full-scale system.

#### 4.1.2. Evaluation of cosubstrate mixtures in the AcD process.

The AcD process was fed using the EFF mixture from the beginning until the day 54 of the assay with an average of OLR = 3.09 ± 0.32 gCOD/L.d, Q<sub>B</sub> = 1.22 ± 0.04 L<sub>biogas</sub>/d and a consequent biogas production rate of 126 ± 11 L<sub>biogas</sub>/KgVS (Figure 32). This value was lower than the typical reported values for the AD of the CM and near to the value reported by Lo *et al.* in 1986 (Lo, Chen *et al.* 1986) (Table 3). This result could be explained because the influent VS was composed by the DFR and the last one by the lignocellulosic organic matter. This type of organic matter is not really biodegradable by the anaerobic processes. Additionally, the pH and the alkalinity measured in this condition (6.68 and 1203 mgCaCO<sub>3</sub>/L) for the anaerobic process were lower than the optimal for the typical AcD process (6.5-8.5 and 2000-6000 mgCaCO<sub>3</sub>/L) (Astals, Nolla-Ardèvol *et al.* 2012). The DFR also contribute to decrease the pH of the influent mixture because this come from the lactic acid fermentation (pH = 4.19 ± 0.04).

The complete lab-scale process results are presented in the appendices chapter (Appendix D).

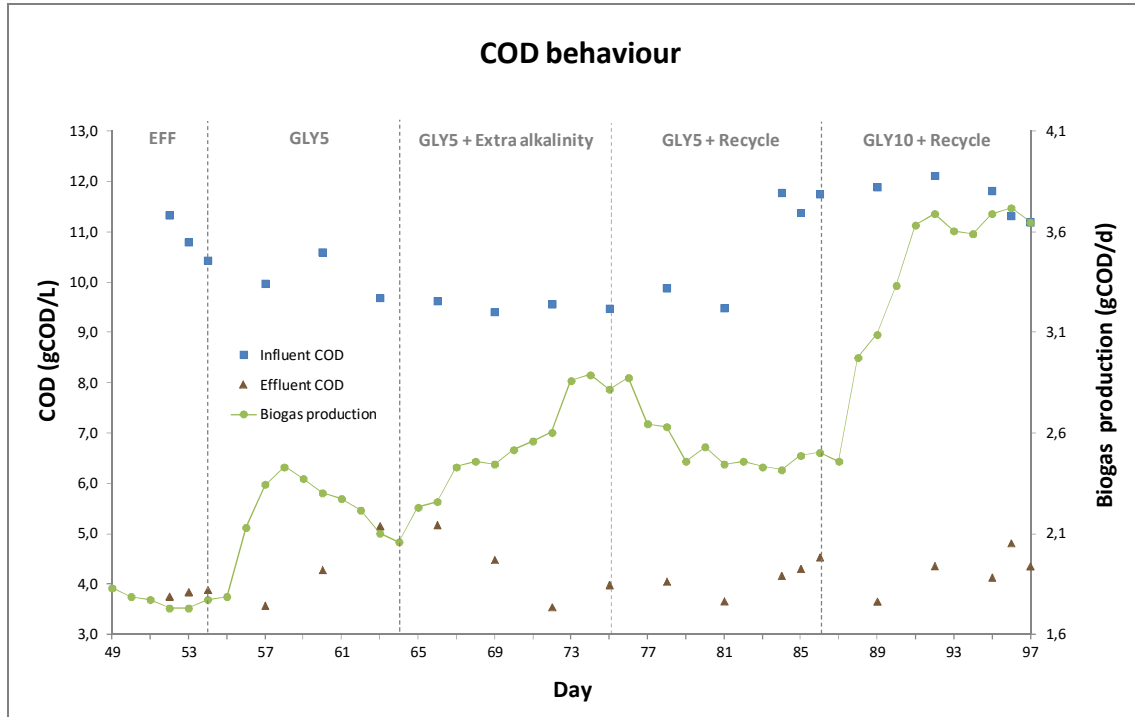

**Figure 32.** COD behaviour in the AcD process.

After the steady state condition was achieved, the 5 % of the TS in the influent mixture was changed by GLY. The biogas production dropped subsequently with the addition of GLY and the COD of the effluent of the digester was increased (Figure 32 - GLY5 step). So, the AcD process was inhibited by any effect which decreased the biogas production with the addition of this cosubstrate (Figure 33). This also was evidenced by the rise of the TAc and the VFA concentration, and the decline of the Alk and the pH in the reaction mixture.

The anaerobic breakdown of the glycerol produces several organic acids as formic, succinic and propionic acids (Figure 34) (Clomburg and Gonzalez 2013). The low buffer capacity of the system given by the depressed alkalinity produced that the AcD process did not counter the inhibition effects.

In order to define which component was the inhibitor in this step of the AcD process, Ferrer *et. al.* determined the acetic acid concentration ( $< 0.8$  g/L) and the VFA concentration ( $< 3.7$  gCOD/L) as the inhibition values for the long term anaerobic process of CM in termophilic conditions (Ferrer, Vázquez *et al.* 2010). However, Timmerman *et. al.* determined the VFA limited values as 5.0 gCOD/L for the AcD of CM and GLY.

According with the periodic determination of VFA concentration in meq/L by titration and the VFA composition defined in the day 95 of the assay by GC, the VFA and the acetic acid concentrations were expressed in gCOD/L (Table 22). Thus, the acetic acid concentration was 0.0405 g/L and the VFA concentration was 0.0976 gCOD/L and these were below of the inhibition limits. In conclusion, the acidification of the anaerobic process produced by the pH effect (pH = 6.39) was the most important parameter that generated inhibition in this step of the AcD process. This is because the hydrogen ion concentration affects the transportation of the VFA and the sulfhydic acid through the biological membrane (Chen, Cheng *et al.* 2008, Chen, Ortiz *et al.* 2014, Tamkin, Martin *et al.* 2015).

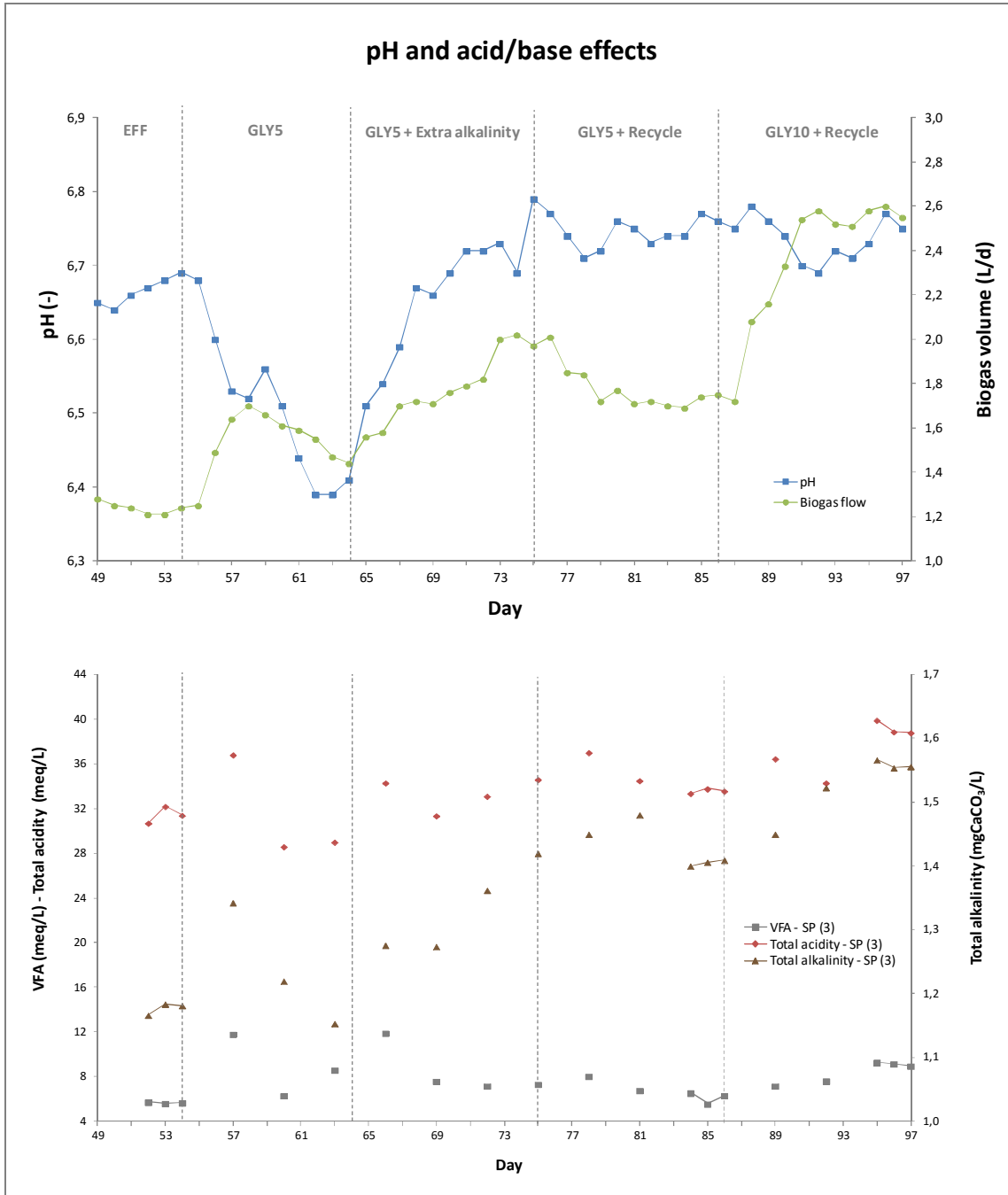

**Figure 33.** pH and acid/base effects in the AcD process. VFA, total acidity and total alkalinity measured each three days of the assay, while these parameters were measured every day in the steady state conditions.

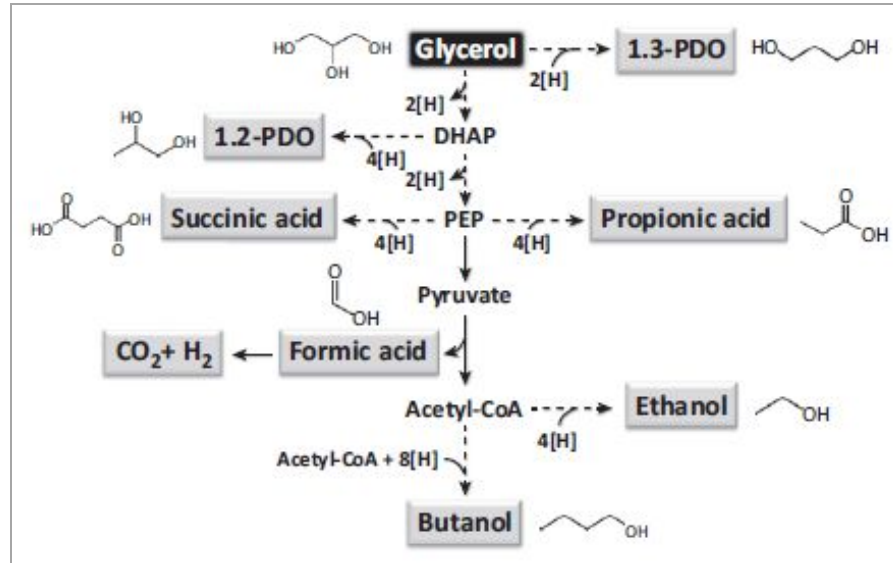

**Figure 34.** Anaerobic fermentation of glycerol (Clomburg and Gonzalez 2013).

**Table 22.** VFA concentration determined by GC and their expression in COD.

Parameter	Units	Acetic acid (C2)	Propionic acid (C3)	Butyric acid (C4)
VFA concentration (day 95)	mg/L	40.5	6.2	24.8
	meq/L	0.674	0.084	0.281
Proportion in VFA	% of meq	64.9	8.1	27.1
Theoretical specific COD in VFAs	mgCOD/meq	64.0	112.0	160.0
Total COD concentration in VFAs	mgCOD/meq		93.9	
Specific VFA concentration	mgCOD/L	43.2	9.4	45.0
Total VFA concentration	mgCOD/L		97.6	

With the aim to solve the pH effect in the AcD process, extra alkalinity was added in the influent mixture as  $\text{Na}_2\text{CO}_3$  (350 mg $\text{CaCO}_3$ /L) to improve the conditions for the methanogenic process. After that, the biogas production climbed back and the effluent COD of the reactor slipped back (Figure 32 - GLY5 + Extra alkalinity). Moreover, the pH increased until 6.79 and the VFA concentration dropped to 7-8 meq/L with the addition of extra alkalinity. This step was carried out until the day 75 of the assay and the biogas production rate grown to  $217 \pm 23 \text{ L}_{\text{biogas}}/\text{KgVS}$  ( $\text{OLR} = 3.69 \pm 1.46 \text{ gCOD/Ld}$ ,  $Q_B = 2.00 \pm 0.06 \text{ L}_{\text{biogas}}/\text{d}$ ).

In this context, the addition of the extra alkalinity to the influent mixture will produce an expensive operation of the full-scale system. The natural resource of the Alk must be found within a low-cost treatment system. Furthermore, the recycle of the effluent in the system aims to decrease the water consumption in the farm, using the effluent for cleaning proposes. The effluent of the treatment system had an alkalinity of  $1085 \pm 534 \text{ mgCaCO}_3/\text{L}$  and a pH value of  $8.35 \pm 0.76$ . The substitution of the GW by the treated effluent (400 mL/d of 755 mL/d of GW used initially) decreased the biogas production but the pH and Alk were stable in the appropriate values (Figure 32 and 33 - GLY5 + Recycle). However, the COD



removal efficiency was the same before and after the recycle. This is because a part of the GLY added was used to denitrification process as readily biodegradable COD (RBCOD) required in this biochemical pathway. The effluent of the treatment system had low concentration of  $\text{NH}_4^+$  and high concentration of  $\text{NO}_3^-$  and  $\text{NO}_2^-$  by the processes involved in the stone filter and in the pond. Now, some N of the influent mixture was released to the atmosphere as  $\text{N}_2$  by the denitrification in the reactor with its recycle. This hypothesis will be explained in the nitrogen analysis for the complete system in the corresponding section (4.2.1.). In this stage that lasts until the day 86 of the assay, the biogas production rate decreased to  $159 \pm 16 \text{ L}_{\text{biogas}}/\text{KgVS}$  ( $\text{OLR} = 4.39 \pm 0.21 \text{ gCOD}/\text{L.d}$ ,  $Q_B = 1.73 \pm 0.08 \text{ L}_{\text{biogas}}/\text{d}$ ).

In order to improve the biogas production and to confirm the hypothesis of the use of GLY as RBCOD by the denitrification process, the GLY was increased to 10 % of TS instead of initial EFF (Figure 32 and 33 - GLY10 + Recycle). The pH decreased again with the addition of GLY but the buffer capacity of the system prevented a dramatic drop in the pH and the biogas production as occurred in the first addition of glycerol (GLY5). Despite of the TAc and the VFA concentration levelled off to  $39.19 \pm 1.53 \text{ meq}/\text{L}$  and  $9.14 \pm 0.41 \text{ meq}/\text{L}$  respectively, these concentrations did not achieve inhibitory values. On the other hand, the biogas production rate was stabilized in  $235 \pm 1 \text{ L}_{\text{biogas}}/\text{KgVS}$  ( $\text{OLR} = 4.32 \pm 0.31 \text{ gCOD}/\text{L.d}$ ,  $Q_B = 2.58 \pm 0.06 \text{ L}_{\text{biogas}}/\text{d}$ ). To summarize, the addition of the GLY in the influent mixture produced an increase in the biogas production and the recycle of the system effluent provided the buffer capacity to counter the acidification of the AcD process.

In contrast, the recycle of the effluent produced the accumulation of the  $\text{S}_i$  and TP in the anaerobic sections (Appendix D). This is because both components were not removed by the biological process. The  $\text{COD}_s$  in the effluent of the AD process increased, after 45 d of recycle, from  $0.92 \text{ gCOD}/\text{L}$  in EFF condition until  $2.40 \text{ gCOD}/\text{L}$  in GLY10+R. Additionally, the TP in the point 3 rose from  $24.0 \text{ mgP}/\text{L}$  to  $85.7 \text{ mgP}/\text{L}$  (EFF and GLY10+R respectively). For this reason, in the futures works the numbers of cycles must be defined to avoid the inhabitation of the AcD process by these accumulations.

#### 4.1.3. Biogas production rates.

A deeper analysis of the biogas production behaviour is presented below (Figure 35). Firstly, when the system was fed using the EFF mixture, the biogas production rate was lower than the reported values for the CM as substrate by Timmerman *et. al.* ( $126 \pm 11 \text{ L}_{\text{biogas}}/\text{KgVS}_{\text{added}}$  instead of  $260 \text{ L}_{\text{biogas}}/\text{KgVS}_{\text{added}}$ ). However, this value was near to the one reported by Lo *et. al.* in 1986 of  $93 \text{ L}_{\text{biogas}}/\text{KgVS}_{\text{added}}$  (Table 3). The EFF mixture was also composed by DFR that decreased the pH of the influent mixture; which determined that the reaction pH was lower than the optimal ( $\text{pH} = 6.68 \pm 0.02$  instead of optimal  $\text{pH} \approx 7-8$ ).

On the other hand, the biogas production rate when the extra alkalinity was added in the GLY5 condition was  $217 \pm 23 \text{ L}_{\text{biogas}}/\text{KgVS}_{\text{added}}$ . This results showed the pH and the Alk effects explained in section 4.1.2.. After starting the recycle of the effluent, the biogas production rate dropped to  $159 \pm 16 \text{ L}_{\text{biogas}}/\text{KgVS}_{\text{added}}$  because the denitrification process of the  $\text{NO}_3^-$  and  $\text{NO}_2^-$  consumed a part of the GLY as RBCOD. Finally, the GLY10+R results confirmed these last assumptions, of the denitrification process, and the biogas production rate increased to  $235 \pm 11 \text{ L}_{\text{biogas}}/\text{KgVS}_{\text{added}}$ . However, this value was not as expected based in the previous report of Timmerman *et. al.* in 2015, where  $485 \text{ L}_{\text{biogas}}/\text{KgVS}_{\text{added}}$  for the AcD process of CM and GLY (5 %) was reported (Timmerman, Schuman *et al.* 2015). The HRT of the system (20 d in the Timmerman's work), the influent characteristics (without DFR in the Timmerman's work), and the recycle effects (denitrification process) are the suggested

reasons to explain the mismatch with the reported values. In contrast, this lab-scale system allowed the GLY addition, the N removal by the anaerobic process and also to save GW in the farm. In summary, the addition of the GLY as cosubstrate along with the recycle of the effluent (as Alk source), improved the biogas production and decline the GW consumption in the lab-scale anaerobic reactor (10 % of GLY and 57 % of the GW consumed).

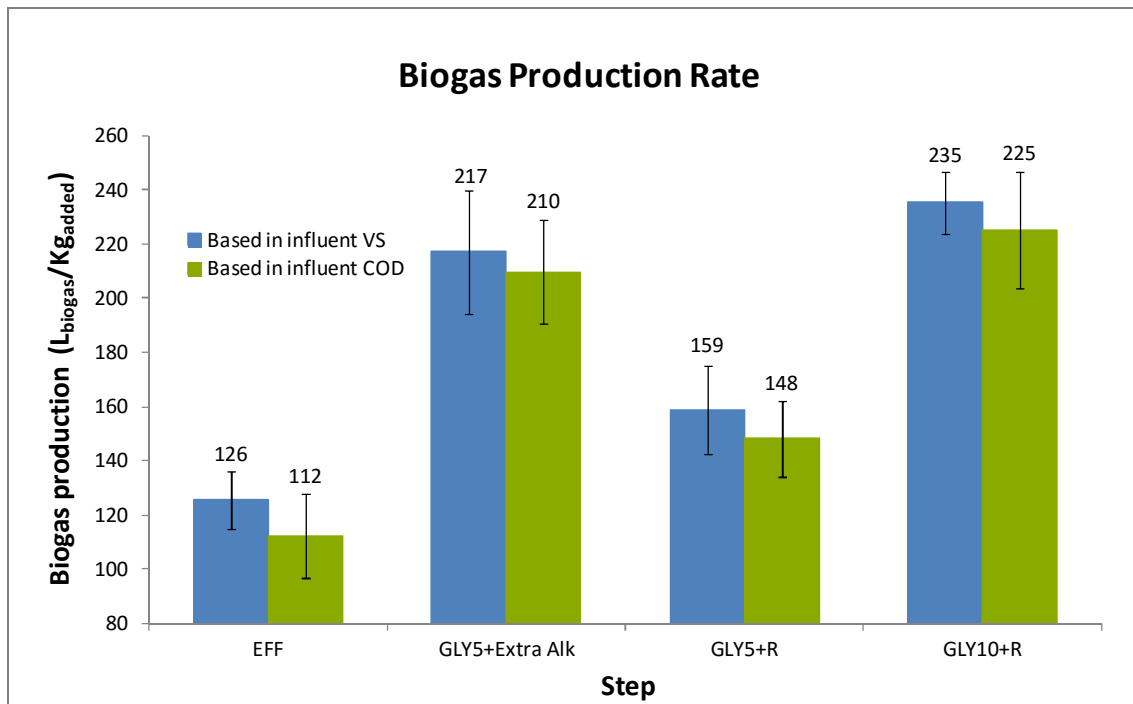

Figure 35. Biogas production rates determined in the AcD process.

#### 4.1.4. Stoichiometric and mass balance of the AcD process.

The mass balance of COD in the reactor was calculated after the steady state conditions were achieved for the EFF and GLY10+R (days 52-54 and days 95-97 of the assay respectively). These calculations were done based in the average of the influent and effluent COD and the average of the biogas production (Appendix D). The biomass yields (E) were defined as 0.068 gCOD/gCOD (6.8 %) for the EFF mixture and 0.101 gCOD/gCOD (10.1 %) for the GLY10+R, in the previous section 4.1.1. The CH<sub>4</sub> concentration in the biogas was determined by GC in the day 97 of the assay and its content was 57.2 ± 10.9 % (Table 23).

Table 23. Methane concentration in the biogas mixture.

Parameter	Units	Determination			Average	Confidence interval
		A	B	C		
Methane concentration (day 97)	mmolCH <sub>4</sub> /L	25001	21627	22414	23014	4385
Volume (T = 30 °C, P = 1 atm)	L/L <sub>biogas</sub>	0.621	0.537	0.557	0.572	0.109
Concentration	%	62.1	53.7	55.7	57.2	10.9
COD in biogas (S <sub>m</sub> )	gCOD/L <sub>biogas</sub>	1.384	1.434	1.473	1.431	0.111

### EFF condition

$$\text{COD}_{\text{IN}} = 0.755 \text{ L/d} \times 10.86 \text{ gCOD/L} = 8.20 \text{ gCOD/d}$$

$$\begin{aligned}\text{COD}_{\text{OUT}} &= 0.690 \text{ L/d} \times 3.83 \text{ gCOD/L} + 0.033 \text{ L/d} \times 18.93 \text{ gCOD/L} \\ &\quad + 1.22 \text{ L}_{\text{biogas}}/\text{d} \times 1.431 \text{ gCOD/L}_{\text{biogas}} + 0.068 \times 10.86 \text{ gCOD/L} \\ &= 5.75 \text{ gCOD/d}\end{aligned}$$

$$\text{COD}_{\text{IN}} \neq \text{COD}_{\text{OUT}} \text{ (70\%)}$$

### GLY10+R condition

$$\text{COD}_{\text{IN}} = 0.755 \text{ L/d} \times 11.45 \text{ gCOD/L} = 8.64 \text{ gCOD/d}$$

$$\begin{aligned}\text{COD}_{\text{OUT}} &= 0.690 \text{ L/d} \times 4.44 \text{ gCOD/L} + 0.033 \text{ L/d} \times 16.55 \text{ gCOD/L} \\ &\quad + 2.58 \text{ L}_{\text{biogas}}/\text{d} \times 1.431 \text{ gCOD/L}_{\text{biogas}} + 0.101 \times 11.45 \text{ gCOD/L} \\ &= 8.46 \text{ gCOD/d}\end{aligned}$$

$$\text{COD}_{\text{IN}} \approx \text{COD}_{\text{OUT}} \text{ (98\%)}$$

While the COD mass balance for the GLY10+R condition closed completely (98 %), the outlet COD did not achieve the inlet COD flux and the mass balance did not fix for the EFF step (70 %). Probably, some sludge was washed out in the effluent flow of the settler before being treated. This is because the scum formation inside of the reactor was a problem for the operation of the digester in the beginning of the assay (Appendix A, Figure 50). However, in the others steps the COD mass balance closed for the E = 10.1 % (95 % for GLY5+Extra alkalinity and 82 % for GLY5+R conditions). In these cases, a part of the influent COD was quickly used (GLY) and the effluent of the settler had lower solids contents and scum formation. Additionally, the methane concentration was measured in the GLY10+R condition and the assumption of the same concentration in the complete assay was not appropriate.

In order to define the stoichiometry of the anaerobic reaction, the overall molecular formula of the  $\text{COD}_{\text{B},i}$  were defined by the section 4.1.1. and its results were  $\text{C}_{1.000}\text{H}_{1.663}\text{O}_{0.336}\text{N}_{0.225}\text{P}_{0.007}$  for the initial condition (EFF) and  $\text{C}_{1.000}\text{H}_{2.096}\text{O}_{0.609}\text{N}_{0.153}\text{P}_{0.045}$  for the final condition (GLY10+R). With this values the electron donating capacity of the substrate were  $\gamma_{\text{S}} = 4.349 \text{ e}^-/\text{mol}$  and  $\gamma_{\text{S}} = 4.645 \text{ e}^-/\text{mol}$  (for EFF and GLY10+R respectively). The overall molecular formula for the methanogenic biomass was defined by Rittman and McCarty in 2001 for a nutrient broth and was  $\text{C}_{4.1}\text{H}_{6.8}\text{O}_{2.2}\text{NP}_{0.1}$  (or  $\text{C}_{1.000}\text{H}_{1.659}\text{O}_{0.537}\text{N}_{0.244}\text{P}_{0.024}$ ) (Rittman and McCarty 2001). In this case, the electron donating capacity of the biomass was  $\gamma_{\text{B}} = 3.973 \text{ e}^-/\text{mol}$ . Additionally, the  $\text{H}_2\text{PO}_4^-$  fraction of the total orthophosphate concentration at the  $\text{pH} \approx 6.7$  (6.68 in EFF and 6.75 in GLY10+R) was assumed as  $f = 0.6$  ( $\text{pK}_{\text{a}2} = 7.21$ ).

So, the anaerobic reactions for the both conditions involved in this analysis were the following.

#### EFF condition

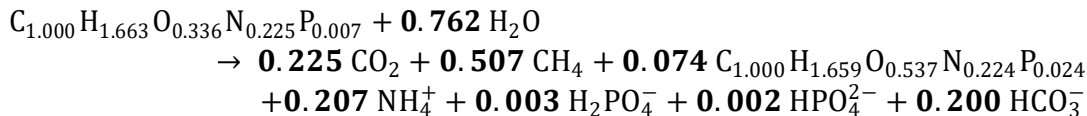

#### GLY10+R condition

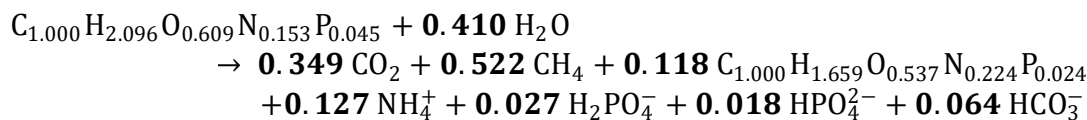

Consequently, with these equations, the theoretical methane content in the biogas was higher in the GLY10+R conditions than the EFF (0.507 and 0.522 respectively). This was also confirmed by the determination of the methane content in the AB test where they were determined as  $58.8 \pm 7.8 \%$  in the initial condition and  $59.4 \pm 9.1 \%$  in the final condition (Table 18). Additionally, the coefficient of the biomass cells was lower in the EFF than the GLY10+R conditions, as was showed in the AB test (6.8 % and 10.1 % respectively).

With the aim to confirm the stoichiometry of the anaerobic reaction, the theoretical calculation was compared with the experimental data from the lab-scale assay (Appendix D, Table 24). If the mass balance of  $COD_T$  in the EFF conditions had closed, the  $COD_{T,e}$  should be equal to 7.38 gCOD/L instead of 3.83 gCOD/L (considering the scum problems produced in the reactor). This new value was used to check the theoretical assumptions.

The parameters obtained from the experimental data measured in the steady state for the EFF and the GLY10+R conditions were compared with the theoretical ones. In the theoretical calculations, the  $f_{AD} = 0.8$  was applied because a low biodegradability in the anaerobic conditions after SRT = 50 d was assumed. From the section 4.1.1., the  $E = 6.8 \%$  or  $10.1 \%$  and  $f_{upi} = 0.50$  or  $0.32$  were used (EFF and GLY10+R conditions respectively). The experimental data of  $NH_4^+$ ,  $PO_4^{3-}$  and Alk produced were calculated based in the outlet flux minus inlet flux in the overall AcD process (points 1, 3 and 4 in Figure 21).

The comparison of the theoretical calculations from the anaerobic reaction and the experimental data showed some differences between both. While the theoretical  $S_m$  in the EFF condition was near the experimental value, in the GLY10+R condition the experimental  $S_m$  was significantly lower than the predicted. Additionally, the  $COD_{BIOM}$ ,  $NH_4^+$ ,  $PO_4^{3-}$  and the Alk evidenced the presence of the others biological communities that grew and fixed N and P in these conditions. Perhaps, the denitrification process could take place in the recycle scenarios because a part of the GLY could be used as RBCOD. Thought the low biogas production in the GLY10+R condition can be explained by this environmental process, the experimental behaviour of the Alk did not follow only the denitrification process. Nevertheless, the AOM process could reduce the Alk of the anaerobic system by the production of  $H^+$  (Figure 37). Moreover, the estimated  $pCH_4$  was greater than the experimental results, maybe the Alk and the salts behaviour (N- and P-compounds) affected the solubility of  $CO_2$  in the liquid phase.

**Table 24.** Comparison of the experimental data with the theoretical analysis in the AcD process. Experimental data: (a) from  $Q_B$  and COD content in biogas. (b) from equation 14 in mol/d ( $Q_i \text{COD}_{T,i} * E / (8 * \gamma_B)$ ). (c) from biomass balances of  $\text{NH}_4^+$ ,  $\text{PO}_4^{3-}$  and Alk in CV1 and divided by the molecular weight. (d) The biogas composition assumed as only  $\text{CH}_4$  and  $\text{CO}_2$ , based in the ideal gas law ( $P \cdot (Q_B * (1 - \text{CH}_4)) / (RT)$ ).

Parameter	Symbol	Units	Theoretical			Experimental	
			Equation	EFF	GLY10+R	EFF	GLY10+R
Remainder biod. COD	$\text{COD}_B$	gCOD/d	31	0.912	0.929	-	-
COD converted	$\Delta \text{COD}_B$	mol/d	30	0.054	0.134	-	-
COD in methane produced <sup>(a)</sup>	$S_m$	gCOD/d	32	<b>1.74</b>	<b>4.47</b>	<b>1.75</b>	<b>3.70</b>
COD in biomass produced <sup>(b)</sup>	$\text{COD}_{\text{BIOM}}$	gCOD/d	33	0.13	0.50	0.56	0.87
Ammonium produced <sup>(c)</sup>	$\text{NH}_4^+$	mgN/d	34	155.4	237.2	17.6	2.0
Orthophosphate produced <sup>(c)</sup>	$\text{PO}_4^{3-}$	mgP/d	35	8.1	185.1	-2.1	-0.61
Alkalinity produced <sup>(c)</sup>	Alk	gCaCO <sub>3</sub> /d	36	0.54	0.43	0.21	0.34
CO <sub>2</sub> produced <sup>(d)</sup>	CO <sub>2</sub>	mol/d	37	0.011	0.009	0.021	0.044
Partial pressure of CH <sub>4</sub>	$p\text{CH}_4$	-	38	0.72	0.89	-	0.57

In summary, these theoretical estimation of the stoichiometry and the mass balances involved in the AcD process were not completely satisfactory because other biological process could took place in the system and these were not considered in the models. However, the  $S_m$  predictions were an accurate estimation of the biogas and energy production by the system.

#### 4.1.5. Kinetic evaluation of the hydrolysis/acidogenic processes

Two kinetics models for the limiting biological step were evaluated with the experimental data (Monod or 1<sup>ST</sup> order specific models). The experimental data used were the determined in the Table 24 for the EFF and GLY10+R conditions. The results of this comparison were showed in the following table (Table 25). In theoretical calculations, the  $f_{AD} = 0.8$  was applied because a low biodegradability in the anaerobic conditions after SRT = 50 d was assumed. From the section 4.1.1., the  $E = 6.8\%$  or  $10.1\%$ ,  $Y_{AD} = 6.1\%$  or  $9.1\%$  and  $f_{upi} = 0.50$  or  $0.32$  were used (EFF and GLY10+R conditions respectively). Additionally, the kinetics constants used were corrected by temperature from the reported values by Pavlostathis *et. al.* ( $\mu_m = 0.061 \text{ d}^{-1}$ ,  $K_S = 260 \text{ mgCOD/L}$ ,  $K_H = 0.279 \text{ L/gCOD.d}$  and  $b_{AD} = 0.035 \text{ d}^{-1}$  at  $30^\circ\text{C}$  as working temperature) (Pavlostathis and Giraldo-Gomez 1991).

The  $\text{COD}_B$  results obtained from the kinetics models by the Equations 51 and 52 were not reasonable in both cases. These were negatives in the Monod kinetic models and the  $\text{COD}_B$  must be disappeared by the AcD process considering these results. Additionally, the reminder biodegradable COD given by the 1<sup>ST</sup> order specific model were higher than the influent  $\text{COD}_{B,i}$  (4.14 gCOD/L and 6.90 gCOD/L in the EFF and GLY10+R conditions) and the  $\text{COD}_B$  must be produced by the AcD process considering these results. However, when the  $\text{COD}_B$  were substituted by the results obtained from the stoichiometry section (Equation 31, Table 24), the kinetics models improved its results. As a consequence, the Monod kinetic model was near to fit the theoretical and the experimental data. The Monod predictions were  $S_m = 1.89 \text{ gCOD/d}$  and  $S_m = 3.56 \text{ gCOD/d}$  and the stoichiometry model predicted the  $S_m = 1.75 \text{ gCOD/d}$  and  $S_m = 4.47 \text{ gCOD/d}$ , instead of the  $S_m = 1.75 \text{ gCOD/d}$  and  $S_m = 3.70 \text{ gCOD/d}$  obtained experimentally (always EFF and GLY10+R respectively). In

conclusion, the Monod kinetics model was better fitted with the experimental values than the 1<sup>ST</sup> order specific, although the stoichiometry results of the remainder biodegradable COD were used instead of the predicted by the kinetics models. The measurement of the  $Z_{AD}$  must be done to confirm these assumptions because the theoretical predictions did not fit with the experimental data obtained from the AB assay.

**Table 25.** Comparison of the experimental data with the theoretical analysis of the kinetics of the AcD process. (a) New values of  $COD_B$  were taken from stoichiometry determinations (Table 24) because the kinetics results were not reasonable. (b) Experimental data estimated from the acidogenic yields determined in section 4.1.1. ( $Q_i, COD_{T,i}, Y_{AD}$ ). (c) From  $Q_B$  and COD content in biogas.

Parameters	Theoretical						Experimental	
	Monod			1 <sup>ST</sup> order specific			EFF	GLY10+R
	Eq.	EFF	GLY10+R	Eq.	EFF	GLY10+R		
<i>Before assumptions</i>								
Remainder COD ( $COD_B$ ) (in gCOD/L)	51	-0.267	-0.271	52	7.910	5.302	-	-
Acidogenic biomass produced ( $Z_{AD}$ ) <sup>(b)</sup> (in gCOD/d)	50	-0.203	-0.072	50	-0.203	-0.072	0.500	0.786
Methane production ( $S_m$ ) (in gCOD/d) <sup>(c)</sup>	54	14.10	5.15	55	-147.78	-33.95	1.75	3.70
Hydrolysis rate ( $r_H$ ) (in gCOD/L.d)	39	0.043	0.016	40	-0.447	-0.107	-	-
<i>After assumption of <math>COD_B</math> from stoichiometry</i>								
Remainder COD assumed ( $COD_B$ ) <sup>(a)</sup> (in gCOD/L)	45	1.208	1.231	45	1.208	1.231	-	-
Acidogenic biomass produced ( $Z_{AD}$ ) <sup>(b)</sup> (in gCOD/d)	50	0.115	0.225	50	0.115	0.225	0.500	0.786
Methane production ( $S_m$ ) (in gCOD/d) <sup>(c)</sup>	54	<b>1.90</b>	<b>3.59</b>	55	12.85	24.63	<b>1.75</b>	<b>3.70</b>
Hydrolysis rate ( $r_H$ ) (in gCOD/L.d)	39	0.008	0.015	40	0.052	0.102	-	-

## 4.2. Asses the performance of the secondary and tertiary treatment

### 4.2.1. Nitrogen behaviour in the secondary and tertiary treatment.

The N-compounds concentrations in the water line are presented in the following figure for the EFF and GLY10+R conditions; and the complete experimental data is shown in the appendix (Appendix D, Figure 36). The TKN and TN concentrations followed mainly the behaviour of the solids in the system. However, these performances also can be explained by the biological processes involved in the system. These environmental processes will be clarified with the behaviour of  $\text{NH}_4^+$ ,  $\text{NO}_3^-$  and  $\text{NO}_2^-$  in the water line.

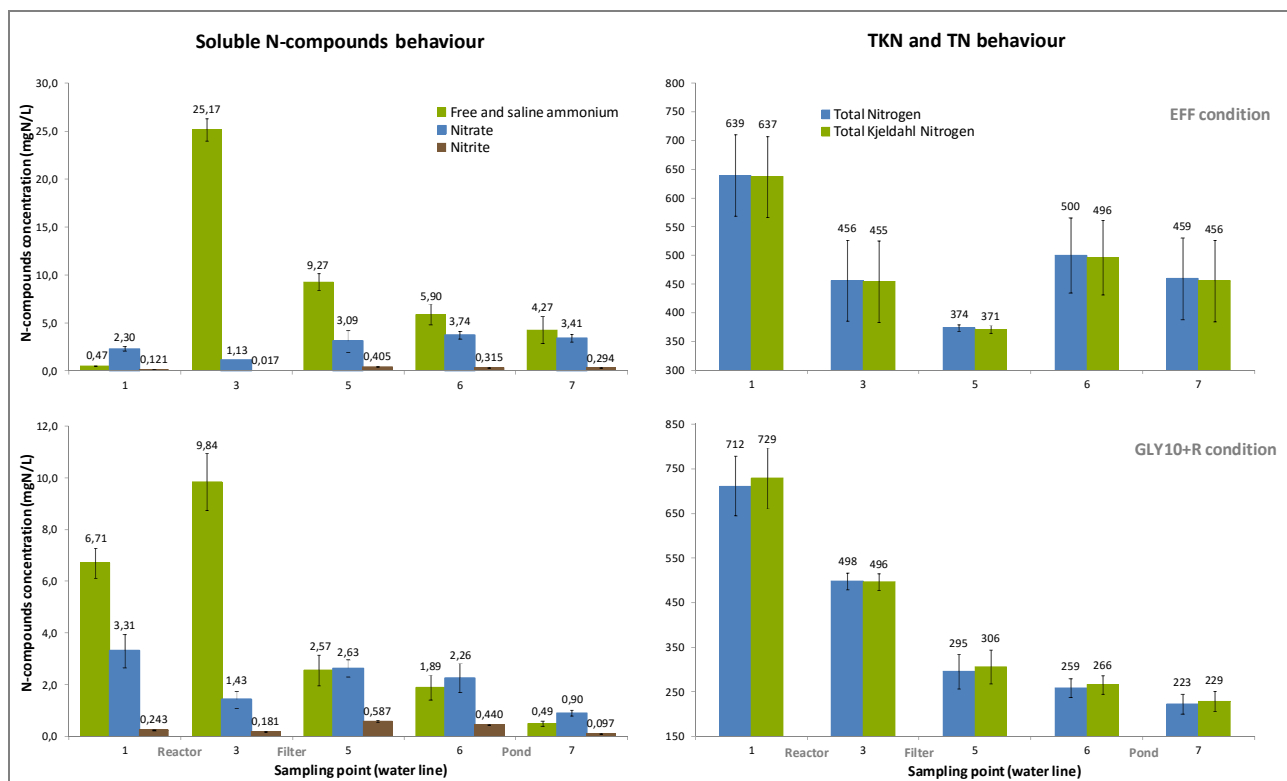

**Figure 36.** Nitrogen behaviour in the EFF and GLY10+R conditions.

The N-compounds concentrations in the influent of the reactor (point 1 of water line) increased with the recycle of the effluent by the accumulation of these salts in the system. In both conditions, between points 1 and 3 (AcD process), the  $\text{NH}_4^+$  concentration increased by the degradation process of the organic matter (ammonification process). In contrast, the concentration of  $\text{NO}_3^-$  and  $\text{NO}_2^-$  decreased after the anaerobic conditions of the reactor (denitrification, AOM or Anammox processes) (Figure 37). While the ammonification in the EFF condition was higher than the GLY10+R condition, the denitrification process was more important in the GLY10+R than the EFF condition (in terms of relative concentration). The evidence of this anaerobic removal of  $\text{NO}_3^-$  and  $\text{NO}_2^-$  for both conditions, confirmed that a part of the RBCOD was consumed for the denitrification or Anammox processes (Figure 37). Nevertheless, this phenomenon was more relevant when the GLY was added than the initial

condition (GLY as RBCOD). While the usage of GLY can be explained by the denitrification and Anammox process, the Alk behaviour did not follow the expected. As a consequence of these several process involved in the anaerobic system, the stoichiometry theoretical estimation of the  $S_m$ , in the GLY10+R condition, was lower than the experimental data.

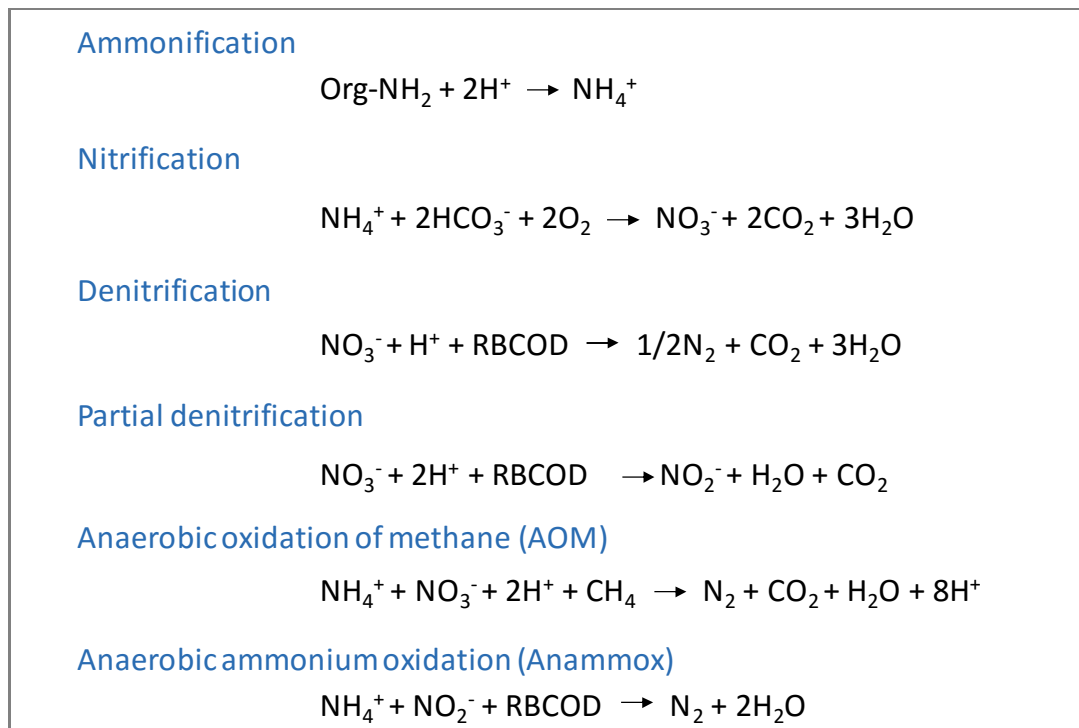

**Figure 37.** Chemical equations of the biological nitrogen processes.

Between points 3 and 6 (two serial stone filters), the  $\text{NH}_4^+$  concentration dropped by the aerobic oxidation of ammonium (nitrification process) with the subsequent rise of  $\text{NO}_3^-$  and  $\text{NO}_2^-$  concentration. This behaviour did not depend of the condition (Figure 36). However, the reduction of the  $\text{NH}_4^+$  did not reflected quantitatively in the increment of the  $\text{NO}_3^-$  and  $\text{NO}_2^-$  concentration, and the N mass balance did not close. Perhaps, this is because the denitrification, AOM or Anammox process also could take place in the stone filters. However, the pH behaviour in the stone filters (point 3 pH =  $6.87 \pm 0.10$  and point 6 pH =  $8.30 \pm 0.11$ ) rose significantly and this can be explained only by the denitrification processes (total or partial). Additionally, the concentration of these N-components also decreased between the points 5 and 6. In summary, the removal of the  $\text{NH}_4^+$ ,  $\text{NO}_3^-$  and  $\text{NO}_2^-$  in the stone filters only could be produced by the aerobic and the anaerobic environments that generated conditions for the nitrification, denitrification, AOM and/or Anammox processes. The coupled removal of  $\text{NH}_4^+$ ,  $\text{NO}_3^-$  and  $\text{NO}_2^-$ , and the excess of soluble  $\text{CH}_4$  in the effluent of the reactor could be an interesting application of the new biochemical pathways found (Haroon, Hu et al. 2013).

The same behaviour of the soluble N-compounds was observed between points 6 and 7 (pond), where the  $\text{NH}_4^+$ ,  $\text{NO}_3^-$  and  $\text{NO}_2^-$  concentration dropped due to the above mentioned biological processes. Nevertheless, only the anaerobic conditions can trigger the simultaneous removal of these ions. Furthermore, the macroscopic observation of this pond showed the development of the red colour biomass in the bottom (Figure 38). This particular growth, a primary microscopic analysis and the operational pH and temperature of this part



of the valorization system evidenced the presence of the Anammox microorganisms (point 6 pH =  $8.30 \pm 0.11$ , T =  $29.5 \pm 2.6$  °C). As a consequence, this biomass was lyophilized in order to conserve as inoculum for others treatment process due to the environmental importance of this biological activity.

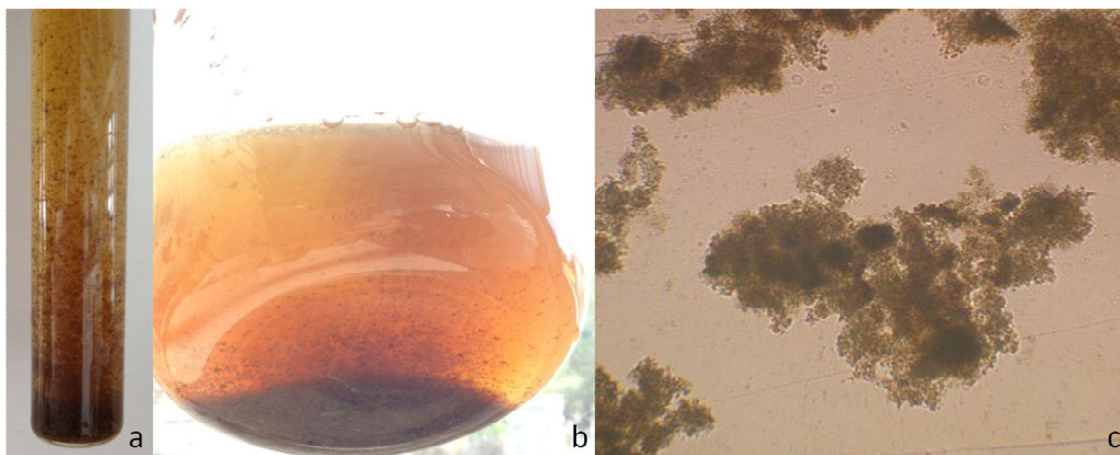

**Figure 38.** Photos of biomass found in the bottom of the pond. a. Red colour biomass resuspended. b. Biomass sedimented. c. Microscopic observation of the conglomerates (x10).

In conclusion, the secondary and tertiary treatments applied could remove the  $\text{NH}_4^+$  produced in the AcD process, while the  $\text{NO}_3^-$  and  $\text{NO}_2^-$  were eliminated in the complete system (anaerobic reactor, filters and pond). The GLY10+R condition showed better results than the EFF condition, probably because the biological processes involved were adapting to the operation with the usage.

#### **4.2.2. Removal efficiency study in the wastewater treatment system.**

The removal efficiencies of the lab-scale system are presented in the following figures and the complete data in appendix chapter (Appendix D, Figures 39 to 41). The recycle of the effluent of the system had a big impact in the total removal efficiencies because in the overall system the discharge decreased significantly (from 500 mL/d to 100 mL/d, 400 mL/d recycled).

Considering the COD and the TSS behaviour, the most important results were that the valorization system removes the  $99.1 \pm 0.3$  % of the influent COD, the  $99.9 \pm 0.1$  % of the influent TSS in the final condition (GLY10+R) (Figure 39). The averaged COD removal efficiencies of each component were 60 % and significant differences between the conditions were not evidenced due to the propagated errors of the determinations did not allow the distinction. However, the TSS removal efficiencies in the anaerobic reactor and in the stone filters were higher than the pond (average of 80 % instead of 50 % respectively). This was because the settler and filter had a big effect in the removal of the TSS as expected. In the EFF condition, the removal efficiency of the pond was only 10 % because this component was recently installed in this step.

According the TN and TP removal efficiencies study, the  $95.9 \pm 0.1$  % of the influent TN and the  $98.1 \pm 0.4$  % of the TP were removed in the GLY10+R scenario (Figure 39). The TN removal efficiencies had big differences between the initial condition (EFF) and the optimal

final condition (GLY10+R) in opposition with the others parameters involved in this analysis. These changes were due to the recycle scenarios where the biological nitrogen processes took place in the reactor, stone filters and in the pond (nitrification, denitrification, AOM and/or Anammox). The TN removal efficiencies rose significantly in the stone filters from an average of  $14 \pm 4$  % to  $55 \pm 11$  % with the recycle of the effluent. Additionally, the same behaviour was evidenced in the pond. On the other hand, the TP removal efficiencies had not several changes between the initial and the final conditions. While the removal efficiency of the reactor decreased from  $45 \pm 16$  % to  $25 \pm 6$  % with the recycle, the removal efficiency of the stone filters grown to  $84 \pm 14$  % from  $64 \pm 13$  %. This last one was the component of the system that had the most important effect in the TP removal.

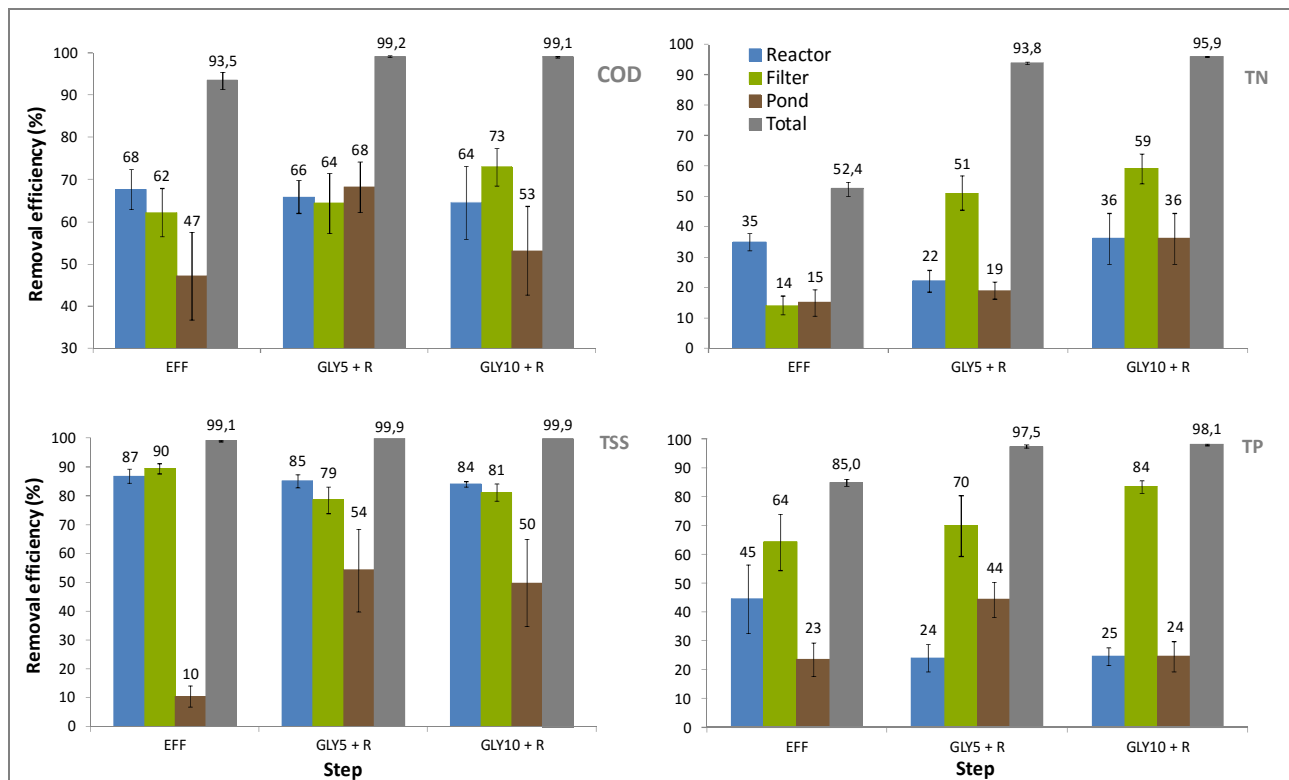

**Figure 39.** Removal efficiency of COD, TSS, TN and TP in the lab-scale system.

The FC were successfully removed from the system with a total removal efficiency of  $99.98 \pm 0.03$  % that correspond with 4 logs in the logarithmic scale (Figure 40). While the anaerobic reactor had not a big impact, the stone filters and the pond were the components of the system that removed the FC. Probably, the removal in the anaerobic reactor was due to the removal of the gross TSS in the water line. In contrast, the reason for the high removal in the stone filters was probably the concomitant effects of the removal of the rest of the TSS and the pH (pH = 7.75 in the point 5). Despite the TSS removal efficiency of the pond was the lowest in the system; the FC removal was the highest. A reason could be the pH effect in the inlet flow of the pond was  $8.30 \pm 0.11$ , although this effect does not explain the high removal efficiency obtained (Fernández, Tejedor et al. 1992). Based in this previous work, values of the pH near 9 only remove the 94 % of the FC instead of the  $99.52 \pm 0.99$  % measured for this pond. However, microscopic analysis of the pond content, revealed the presence of zooplanktons of the phylum rotifer (*Keratella sp.* and *Bdelloidea sp.*) (Figure 41).

The predation of the FC by these organisms along with the high pH produced in this component of the valorization system could have explained the high removal efficiency shown (Enzinger and Cooper 1976). These organisms are usually found in the subsurface flow wetlands and the effects in the removal of pathogens had been previously demonstrated (Decamp, Warren et al. 1999, Proakis 2003).

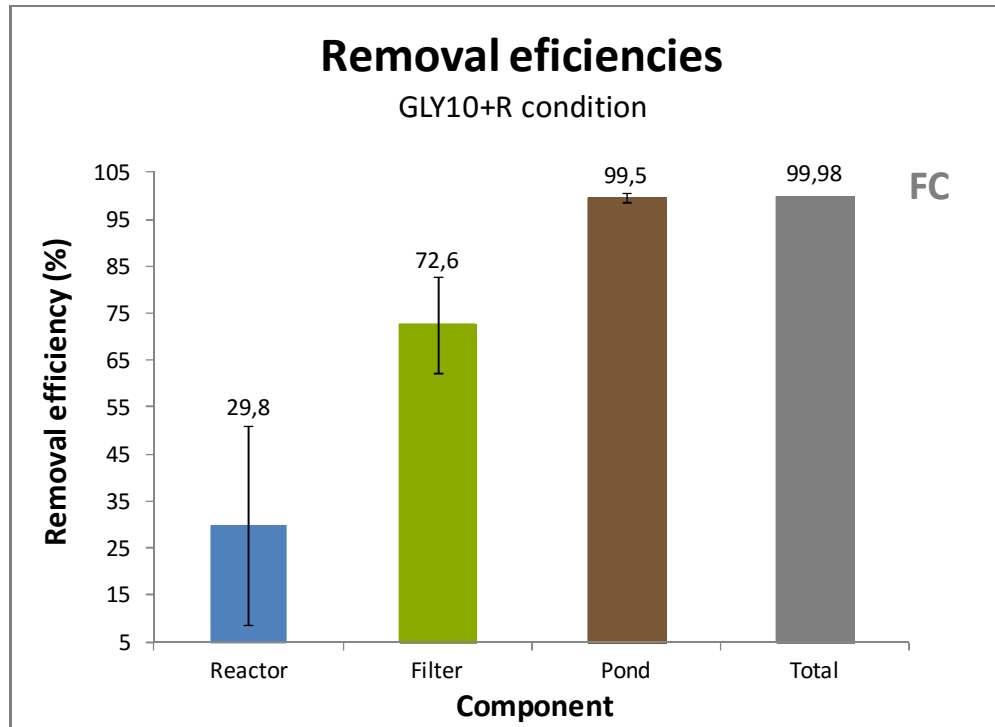

**Figure 40.** Removal efficiency of FC in the lab-scale system for the GLY10+R condition.

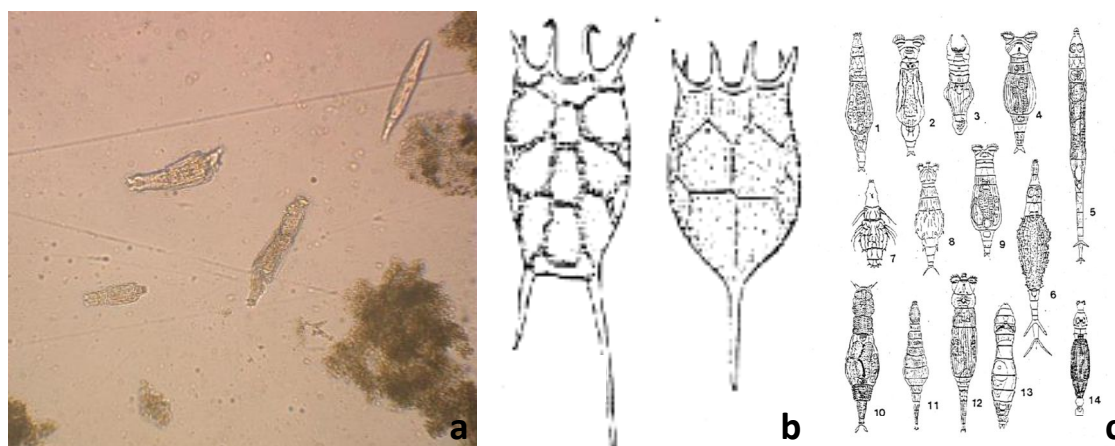

**Figure 41.** Zooplankton found in the pond. (a) Microscopic view of the rotifers founded in the pond (x10). (b) *Keratella* (fam. *Brachionidae*). (c) Morphological construction in *Bdelloids* sp. Draws extracted from Kutikova et. al. (Kutikova 2000).

In summary, the removal efficiencies in the lab-scale system were improved with the addition of GLY and the recycle to the influent mixture. These were  $99.1 \pm 0.3 \%$ ,  $99.9 \pm 0.1 \%$ ,  $95.9 \pm 0.1 \%$  and  $98.1 \pm 0.4 \%$ ; instead of  $93.5 \pm 2.7 \%$ ,  $99.1 \pm 0.3 \%$ ,  $52.4 \pm 3.0 \%$  and  $85.0 \pm 1.7 \%$  (always COD, TSS, TN and TP respectively). Additionally, the FC removal efficiency was  $99.98 \pm 0.03 \%$  and the final effluent concentration was  $2.7 \times 10^2$  UFC/100mL, that allow the irrigation of this effluent without restrictions in the farm ( $1.0 \times 10^3$  UFC/100mL defined by WHO's guidelines) (WHO 1989).

### 4.3. Full-scale valorisation system design

#### 4.3.1. Process flow diagram.

The process flow diagram shows the complete design of the valorization system (Figure 42). Some details in the equipment to install and the involved processes, as well as the flows of nutrients, energy and water are shown for the GLY10+R condition. The flows and concentrations in the system were determined based in the lab-scale results (Appendix D). Moreover, the removal efficiency of each component of the system was extracted from the section 4.2.2..

The FC concentration achieved in the effluent of the water line and in the dewatered sludge were  $2.7 \times 10^2$  UFC/100mL and  $9.0 \times 10^2$  NMP/100g, respectively. These previous results would allow that the sludge and the effluent to be used without restriction in the farm for fertilization proposes. The water quality achieved in the valorization system as well as the inhibitory compounds content ( $\text{NH}_4^+$ ,  $\text{PO}_4^{3-}$ ,  $\text{Si}$ , etc.), would define the water usage in the production system. The P and the  $\text{Si}$  was not removed by the system in the lab-scale, only by the sludge and biomass produced, so its accumulation inside reactor with the successive recycles could be an operation problem in the full-scale system. These components should be eliminated from the system in the dry weather months as the effluent is used for the irrigation of soils.

In addition, 580.4 KgVS/d was the wastewater production assumed for the farm. Consequently, the energy productions considered for the design were 852 KWh/d, 576 KWh/d and 457 KWh/d (GLY10+R, GLY5+R and EFF conditions respectively). The energy requirements for the reactor heating to 30 °C were determined based in an open swimming pool, and efficiencies of the heater exchanger and the boiler of 90 %. The temperature of the wastewater in the winter was defined as 17 °C and 25 °C in summer. As a consequence, the energy required were 424 KWh/d and 165 KWh/d, respectively (295 KWh/d averaged). However, the installation of a Combined Heat and Power (CHP) allows to use the heat produced in the combustion process inside of the generator to warm the anaerobic reactor. For this reason, the energy required to heat the reactor comes from the electricity conversion and this extra energy consumption was not considered in the economical evaluation. As a consequence, the designed electricity production were 298 KWh/d, 202 KWh/d and 160 KWh/d (GLY10+R, GLY5+R and EFF conditions respectively).

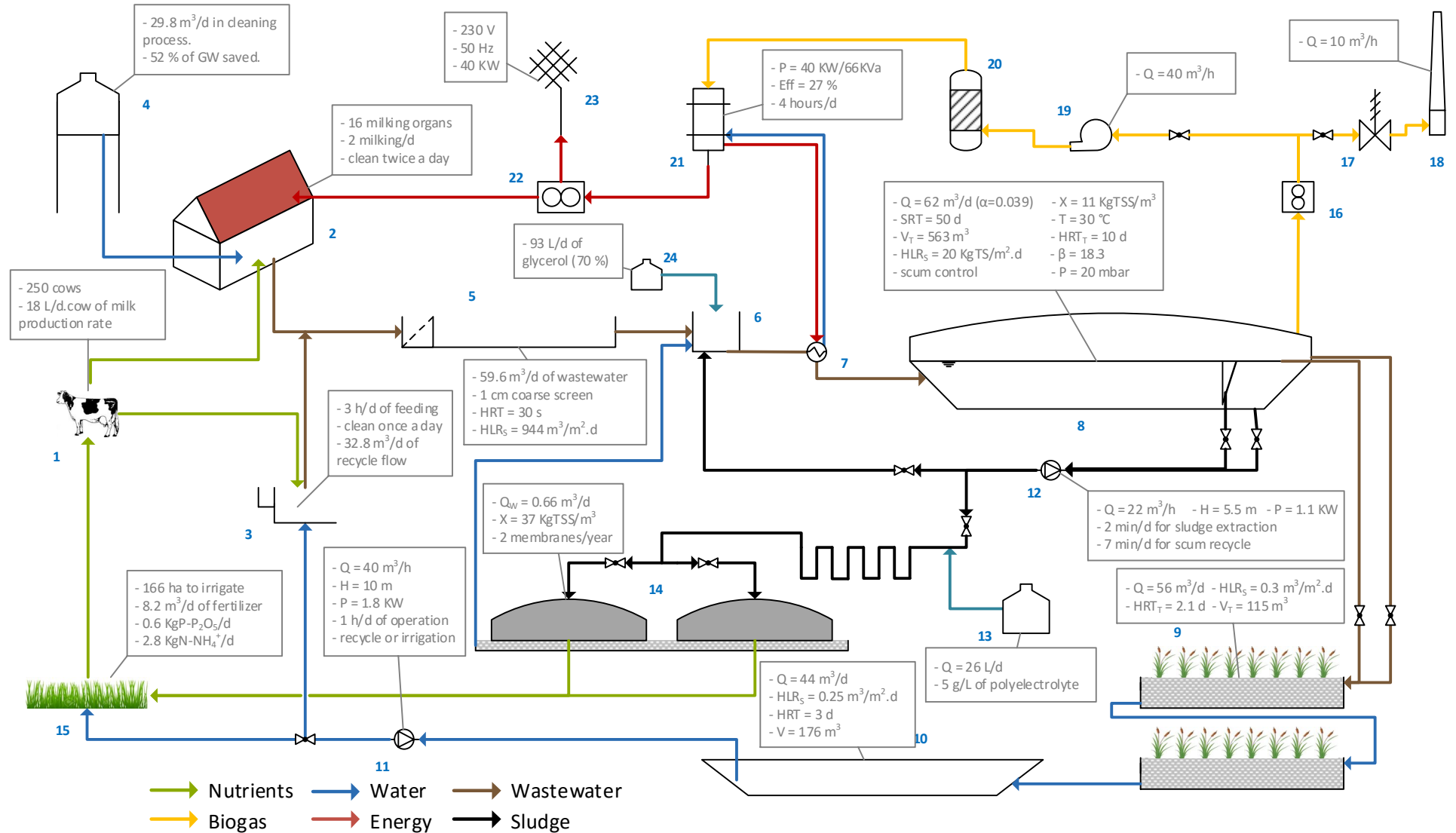

**Figure 42.** Process flow diagram for the GLY10+R condition. 1. Cattle production. 2. Milking process. 3. Feeding process. 4. Groundwater supply. 5. Screen and grit chamber. 6. Distribution box. 7. Heat exchanger. 8. Biogas boiler. 9. Anaerobic reactor and settler. 10. Constructed wetlands. 11. Pond. 12. Recycle p ump. 13. Sludge pump. 14. Flocculant. 15. Sludge dewatering. 16. Meadow. 17. Gas flow meter. 18. Check valve. 19. Safety flame. 20. Blower. 21. Biogas filter. 22. CHP and synchronous. 23. Electricity flow meter. 24. Low voltage net (UTE). 25. GLY reservoir.

### 4.3.2. Preliminary design.

The dimensions of each component were based in the whole system, considering the topography, land space, available materials in the local market and a low-cost budget. Though the hydraulic design was not designed for the present work, the maximum flows of wastewater were defined according with the time of each cleaning process (30 min in the milking place and 10 min in the feeding place). Additionally, the slope assumed for the wall of the excavations was 1:1.5 (horizontal:vertical). The figures with the design are presented in Appendix chapter E.

#### Primary treatment

A coarse screen was designed along with the grit removal in the same chamber (Appendix E, Figure 52). The screen had 1 cm of separation between bars and was inclined 45°. The dimension of the chamber was defined based in  $L/H = 15$ , 60 cm of initial depth, 2 % of slope to move the sediment and the  $HRT = 30$  s. As a consequence, the  $HLR_s$  was equal to  $944 \text{ m}^3/\text{m}^2\cdot\text{d}$ . The distribution box was defined based in the inlets flow and considering the submerged discharge in the reactor. The materials chosen for the construction were polished concrete for the chamber and the stainless steel for the screen.

#### Anaerobic reactor

The anaerobic reactor design considered the incorporation of the settler and the gas holder. (Appendix E, Figure 53). The dimensions of the system were defined based in 3.7 m of the initial depth, 1 % of the slope and the dimensions of the EPDM membranes available. The EPDM membranes will be installed in the bottom and in the top of the reactor. Additionally, a geotextile membrane will be installed below of the bottom membrane to protect it. These membranes are fastened by a concrete rectangular beam. A gutter for the overflow conditions was designed to catch the scum produced inside of the reactor. Thus, two baffles separated 15° were designed to form this gutter. Additionally, a gate of 15 cm of height was defined below of the baffles union to separate the digestion and the settler zones. The water level inside the reactor can be managed by the outlet pipes to remove this scum. To summarize, the design parameters are presented in the table below (Table 26).

#### Sludge dewatering

Due to the pathogens were removed after the drying process in the lab-scale experiment, a design of extra disinfection steps were not needed in the full-scale system (Appendix E, Figure 54). The SRT was defined as 50 d, hence the  $Q_w = 0.66 \text{ m}^3/\text{d}$ . Based in this sludge production, 2 Soiltain® dewatering tubes of 5 m x 7 m (perimeter and large) would be consumed in one year. If the dewatering process takes 6 months, a land space of  $51 \text{ m}^2$  would be needed. A pond filled with washed stones was designed to allow the runoff of the permeated to the reactor. This pond had 10 cm of the initial depth and 1 % of the slope. A protective geotextile will be used in the bottom of the pond to avoid the infiltrations. Additionally, 26 L/d of a polyelectrolyte solution (5 g/L) is needed for the flocculation of the sludge. The dewatering system was designed to purge the sludge from the reactor each 15 days and to change the membranes twice a year.

**Table 26.** Design parameters of the anaerobic reactor.

Parameter	Symbol	Design value	Reference value	Units
Digester volume	$V_D$	490	-	$m^3$
Settler volume	$V_S$	73	-	$m^3$
Total volume	$V_T$	563	-	$m^3$
Sludge retention time	SRT	50	60	d
Total hydraulic retention time	$HRT_{D+S}$	9.4	3-10	d
SRT/HRT	-	5.3	10-100	-
Total solids concentration	$TS_D$	14	25	$KgTS/m^3$
Organic loading rate	OLR	1.39	2-3	$KgCOD/m^3.d$
Volumetric organic loading rate	$OLR_V$	0.36	0.35	$KgBOD/m^3.d$
Sludge organic loading rate	$OLR_S$	0.16	0.13	$KgCOD/KgVSS.d$
Surface organic hydraulic loading rate	$OHLR_S$	30	100-200	$KgTS/m^2.d$

### Constructed wetland

The designed wetlands had a total surface area of  $193 m^2$ , this was enough to achieve the suggested  $HLR_S$  of  $0.3 m^3/m^2.d$  (Appendix E, Figure 55). Additionally, the dimensions were defined based in  $L/B = 8$ , 70 cm of initial depth and a 1 % of slope. Washed stones with 20-50 mm of diameter compose the fixed matrix. Consequently, the subsurface horizontal flow was designed to achieve plug flow conditions and improve the TSS removal. A protective geotextile will be used in the bottom of the wetlands to avoid the infiltrations to the GW.

### Pond

The HRT of the pond was defined as 3 d to ensure a proper pathogen removal by the system. Considering the  $L/W = 1.8$  and the 80 cm of constant depth, the dimensions of the lagoon were determined (Appendix E, Figure 56). Thus, the  $HLR_S = 0.25 m^3/m^2.d$  was according with the load for a typical maturation pond. In order to avoid the infiltrations, a geotextile will be used in the bottom of the pond.

#### 4.3.3. Layout

The layout was designed based in the topography and the terrain available in the ERB dairy farm to use the natural slope to avoid the pump usages. Additionally, the ponds recently built would be used in the construction of the anaerobic reactor (zone 3, Figure 29). The distribution of each component of the layout will follow the wastewater, clean water, sludge and the gas lines (Figure 43). Also, a machine room was designed to storage the electric equipment. The perimeter must be fenced to avoid the accidents caused by animals. Moreover, the sludge dewatering zone was located near to the path because the dried sludge must be taken out by trucks. Following precautionary measures, the security flare was designed in the corner of the wastewater treatment place. Although this is a preliminary design, the hydraulic profile of the system must be determined to confirm the designed layout and the pump usages.

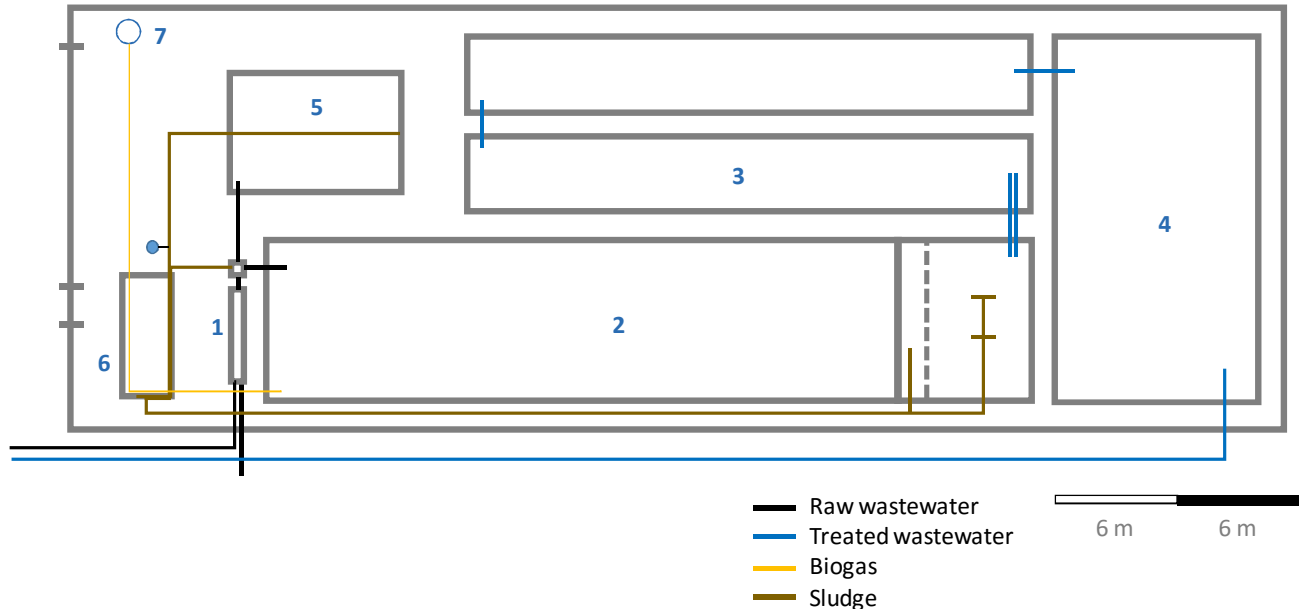

**Figure 43.** Scheme of the layout of the valorization system. 1. Primary treatment. 2. Reactor and settler. 3. Constructed wetlands. 4. Pond. 5. Sludge dewatering zone. 6. Machine room. 7. Security flare.

## 4.4. Preliminary economical evaluation

### 4.4.1. Balance sheet determination

#### Investment costs

The investment costs were determined based in the preliminary design and layout from the previous section. This expense did not change with the condition defined (EFF, GLY5+R or GLY10+R). The total cost of the system was USD 101.451 and the details of the investment are summarized below (Figure 44). However, the variability of this estimation was 25 % due to the preliminary design was used as inlet data. The ‘services’ category was composed by the professional works as automation, architecture and design.

#### Incomes

Following the methodology described in the correspondent section (3.7.1.), the incomes were defined for the three scenarios (Table 27). The energy production considered the biogas production rate and the predicted VS in the effluent of the farm. In addition, the concentration of the methane in the biogas found in the lab-scale experiment (57.2 %) and 35 % of the electrical efficiency in the CHP generator (40 KW), were used to define the electricity production.

Furthermore, the GW saved was calculated based in the recycle of the effluent (52 % of the GW consumed in the EFF condition). The effluent and the sludge dewatered quality will allow its use without restriction by the farm and the synthetic fertilizer can be partially substituted. The sludge produced was defined by the operation SRT and compared with compost. Moreover, the effluent flow to be irrigated in the farm was determined from the lab-scale



experiment and compared with the fertilizer used actually by the farm. In the recycle conditions, a discharge of the 41 m<sup>3</sup>/month was assumed to avoid the toxicity of the PO<sub>4</sub><sup>3-</sup> and S<sub>i</sub> in the AcD process.

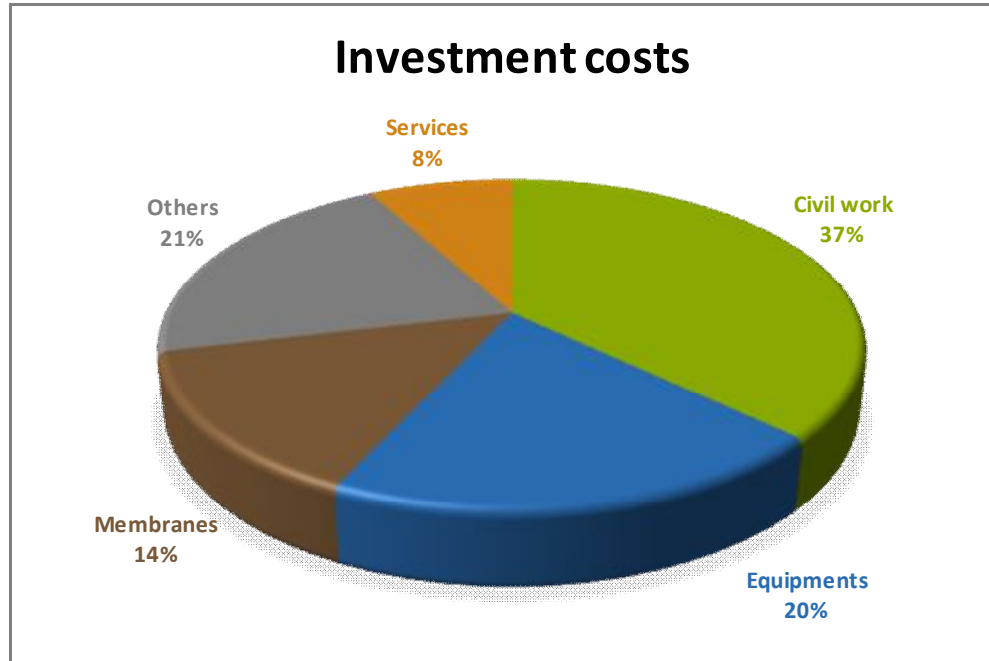

Figure 44. Investment costs details.

Table 27. Incomes estimated for the full-scale system.

Component	GLY10+R	GLY5+R	EFF	Units
Methane production	80	54	43	m <sup>3</sup> /d
Energy production	852	576	457	KWh/d
Energy required for heating proposes	295	295	295	KWh/d
Electricity production	298	202	160	KWh/d
GW saved	32.8	32.8	-	m <sup>3</sup> /d
Sludge production	40.8	40.8	40.8	Kg/d
Effluent production	9.5	9.5	41	m <sup>3</sup> /d

### O&M costs

The O&M costs were determined by the electricity consumption for the pumps, the operation labour, the monitoring cost and the consumables used in the operation of the system (Table 28). A water pump of 1 KW for the effluent recycle and a sludge pump of 1.1 KW were considered. While the extraction of this sludge will be done each 15 days, the disinfectants for the sludge or the effluent were not needed. Consequently, the consumables used by the system were the GLY (70 %), polyelectrolytes, the matrix H<sub>2</sub>S filter and macrofiltration

membranes. In addition, the monitoring costs searched to analyse the valorization system and identify potential problems.

**Table 28.** O&M costs estimated for the full-scale system.

Component	GLY10+R	GLY5+R	EFF	Units
Electricity consumption	1.35	1.35	1.35	KWh/d
Operation labour	2.13	2.13	2.13	h/d
GLY consumption	93	47	-	L/d
Other consumables	5139	5139	5139	USD/year
Monitoring	906	906	906	USD/year

In summary, the behaviour of the incomes and the O&M costs with the different scenarios are presented graphically by the figure below (Figure 45). The fluctuations in the incomes of the system showed that the EFF condition had the highest impact of the nutrients recycle, although the GW saving was important in the recycle conditions. The energy production was the most important income component in the GLY10+R condition. On the other hand, the O&M costs reflex the high influence of the consumables in the three scenarios, where the GLY consumption increased significantly the O&M costs. In addition, the following table showed the annual balance sheets in USD for each condition where the incomes and the O&M costs were considered (Table 29). As a consequence, the annual profitability was improved by the addition of GLY and the recycle of the effluent as operational modifications in the valorization system. In contrast, the annual balances did not include other intangible variables as the solution of the effluent discharge problem (avoiding fines and penalties), the improvement in the quality of life in the establishment (decreasing the diseases vectors and smell around), the organic matter and micronutrients recycle in the farms, and the fiscal benefits for the owners.

**Table 29.** Annual balances sheet in USD.

Component	GLY10+R	GLY5+R	EFF
Electricity production	19.950	16.115	14.461
GW saving	10.775	10.755	-
Organic fertilizer	5.358	5.358	8.638
<i>Subtotal Incomes (USD/year)</i>	<b>36.084</b>	<b>32.248</b>	<b>23.100</b>
Electricity consumption	40	40	40
Operation	3.950	3.950	3.950
Consumables	15.322	10.285	5.139
Monitoring	906	906	906
<i>Subtotal O&amp;M (USD/year)</i>	<b>20.218</b>	<b>15.181</b>	<b>10.034</b>
<b>Total balance (USD/year)</b>	<b>15.866</b>	<b>17.067</b>	<b>13.065</b>

#### 4.4.1. Profitability evaluation

The whole designed system requires an initial investment around USD 100.000, with the 25 % of uncertainty in the preliminary design and without considering external financial sources. The life cycle of the valorization system was defined in the section 3.7.2..

Consequently, the PP, the IRR and the NPV were defined for each studied condition (Figure 46).

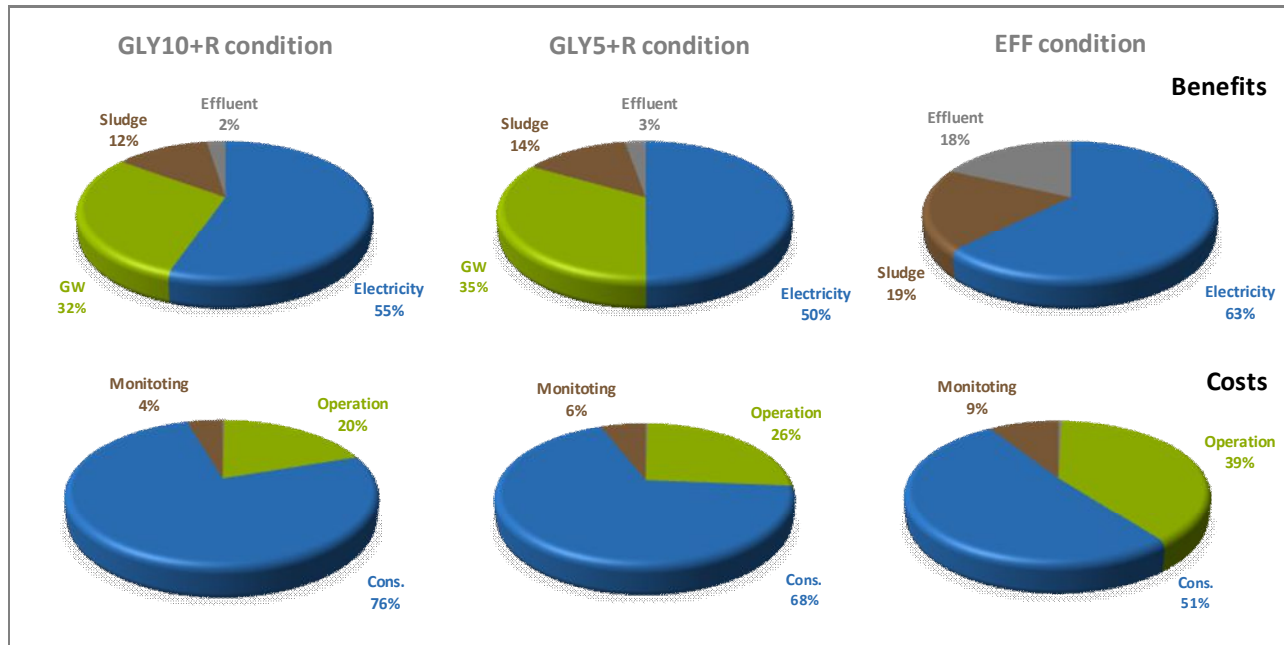

**Figure 45.** Incomes and costs variations in USD.

As a consequence, the profitability of the full-scale valorization system had important fluctuations with the different scenarios. In the figure above, the GLY5+R was the condition where the investment will be restored to the farmers in the shortest time period (PP = 5.9 years). Additionally, this condition had the biggest IRR and the profitability in 7 years (IRR = 2.4 %). However, the NPV were negative for the three scenarios, so the valorization system had an overall initial investment for 7 years of life cycle (USD 40.100 for the GLY5+R). The addition of GLY to the EFF mixture improved the profitability of the valorization system, although the addition of GLY in 10 % of the TS decreased the profits because the consumables costs jump dramatically by the GLY purchase. Moreover, the GW saving and the international price of GLY were the key factors in the profitability evaluation. In contrast, the initial condition when the EFF was valorised had a poor economical results, showed by the PP = 7.8 years, IRR = -1.5 % and NPV = 54.500 USD.

This economical evaluation must be done considering the future economical scenarios (dollar exchange rate, inflation and the international price of consumables). Additionally, a complete approach should consider the social impact in the workers and users, the environmental improvements and the fiscal benefits that increment the life quality.

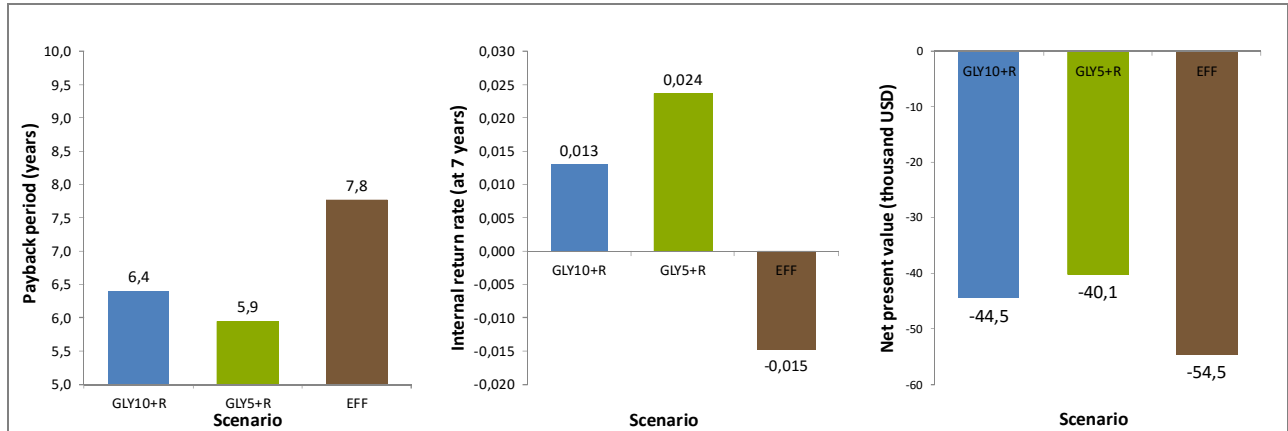

Figure 46. PP, IRR and NPV for different scenarios.

## CHAPTER 5

# Conclusions

A detailed characterization of the effluent from the dairy farm was done. The stoichiometry and the kinetic of the AcD were evaluated using a lab-scale digester. Consequently, the biogas production could be predicted properly using stoichiometry models. However, the kinetics models must be improved to confirm the hydrolysis of the biodegradable particulate COD following the Monod kinetics equation. Additionally, the acid/base system was understood along the addition of the glycerol as cosubstrate. As a consequence, the biogas production rate was improved 87 % with the addition of this cosubstrate and the effluent recycle.

The secondary and tertiary treatment allowed the effluent recycle for the AcD process by the removal of nitrogen compounds. Biological activities found in these treatments represent a promissory future to follow with this work in the study of the low-cost wastewater valorization systems. In addition, the effluent and the stabilized sludge achieved the standards to be applied in the farm without restrictions. The pathogens removal in the last step of the lab-scale system showed the influence of the zooplankton in the elimination of FC in these natural systems. The complete system decreased the initial fluxes in 99.1 % of COD, 99.9 % of TSS, 95.9 % of TN, 98.1 % of TP and 99.98 % of FC; hence the high removal efficiencies capacity of this low-cost system was probed. Additionally, the 52 % of the GW was saved by the recycle of the effluent for cleaning proposes.

A preliminary design of the full-scale valorization system was done considering low-cost technologies. The process flow diagram, the components design and the layout allowed the estimation of the investment and O&M costs. An evaluation of the economical profitability was done considering different operational conditions. The addition of GLY in the influent mixture improved significantly the preliminary feasibility of the full-scale system. However, the GLY5+R was the best economical scenario to be applied in this farm due to the influence of the O&M costs.

A prototype of the designed system must be done to confirm the lab-scale results, the implementation in the current production milking process, the social impacts in the farmers and the environmental improvements.

## CHAPTER 6

# References

- Acosta, Y. (2011). El sector lechero en Uruguay en cifras. Seminario Internacional de Lechería. Chile.
- Achkar, M., A. Dominguez and F. Pesce (2012). "Cuenca del Río Santa Lucía - Uruguay. Aportes para la discusión ciudadana." Uruguay Sustentable.
- Aguirre, M. and P. Varela (2010). Las migraciones internas de los jóvenes en el Uruguay del siglo XXI.
- Aldy, J., J. Hrubovcak and U. Vasavada (1998). "The Role of Technology in Sustaining Agriculture and the Environment." Ecological Economics **26**: 81-96.
- Amon, T., B. Amon, V. Kryvoruchko, V. Bodiroza, E. Pötsch and W. Zollitsch (2006). "Optimising methane yield from anaerobic digestion of manure: Effects of dairy systems and of glycerine supplementation." International Congress Series **1293**: 217-220.
- Antunez, P. (28-04-2015). Clima, precios y gastos le pegan duro a los tambos. El País. Montevideo.
- Aparicio, A. (08-03-2015). Vazquéz ordeno no cbrar el consumo de agua en Maldonado. El País. Montevideo.
- Aparicio, A. (20-03-2013). Advierten riesgo de potabilizada del agua para los próximos años El Observador. Montevideo.
- APHA (2005). Standard methods for the examination of water and wastewater. A. P. H. Association. Washington.
- ARU (2009). Cuantificación de pérdidas ocasionadas por la sequía 2008/2009.
- Astals, S., V. Nolla-Ardèvol and J. Mata-Alvarez (2012). "Anaerobic co-digestion of pig manure and crude glycerol at mesophilic conditions: Biogas and digestate." Bioresource Technology **110**: 63-70.
- Batstone, D. J., J. Keller, I. Angelidaki, S. V. Kalyuzhnyi, S. G. Pavlostathis, A. Rozzi, W. T. M. Sanders, H. Siegrist and V. A. Vavilin (2002). "The IWA Anaerobic Digestion Model No 1 (ADM1)." Water Science and Technology **45**(10): 65-73.
- BCU (2015). PBI anual por industrias, <http://www.bcu.gub.uy/Estadisticas-e-Indicadores/Paginas/Presentacion%20Cuentas%20Nacionales.aspx>.
- Berteche, A. (06-08-2014). Colonización compró casi 40.000 hectáreas y tiene baja morosidad. El País. Uruguay.
- Blasina (05-04-2013). Informes de la DINAMA ratifican contaminación del Río Santa Lucía. El Observador. Montevideo.
- Blasina (14-06-2013). Cuenca del Santa Lucia en jaque. El Observador. Montevideo.
- Blumensaat, F. and J. Keller (2005). "Modelling of two-stage anaerobic digestion using the IWA Anaerobic Digestion Model No. 1 (ADM1). ." Water Research **39**(1): 171-183.
- Brisolara, K. F. and Y. Qi (2011). "Biosolids and sludge management." Water Environment Research **83**(10): 1351-1375.
- Brundtland, G. H. (1987). Our Common Future. Report of the World Commission on Environment and Development, United Nations.

- Burns, R. T. (2009). Current status of manure anaerobic digestion in the U.S. and beyond. Energy production from anaerobic digestion of dairy manure. Madison, USA.
- Bustos, M. (04-04-1997). Ningún país aplica todavía criterios sostenibles en su modelo de desarrollo. El País. Madrid.
- Carrasco-Letelier, L., A. Beretta Blanco and G. Eguren (2014). "Primer mapa nacional de la calidad de agua en Uruguay." INIA **39**: 67-70.
- Castrillón, L., Y. Fernández-Nava, P. Ormaechea and E. Marañón (2011). "Optimization of biogas production from cattle manure by pre-treatment with ultrasound and co-digestion with crude glycerin." Bioresource Technology **102**(17): 7845-7849.
- Castrillón, L., Y. Fernández-Nava, P. Ormaechea and E. Marañón (2013). "Methane production from cattle manure supplemented with crude glycerin from the biodiesel industry in CSTR and IBR." Bioresource Technology **127**: 312-317.
- Castrillón, L., E. Marañón, Y. Fernández-Nava, P. Ormaechea and G. Quiroga (2013). "Thermophilic co-digestion of cattle manure and food waste supplemented with crude glycerin in induced bed reactor (IBR)." Bioresource Technology **136**: 73-77.
- Cavinato, C., F. Fatone, D. Bolzonella and P. Pavan (2010). "Thermophilic anaerobic co-digestion of cattle manure with agro-wastes and energy crops: comparison of pilot and full scale experiences." Bioresour Technol **101**(2): 545-550.
- Clomburg, J. M. and R. Gonzalez (2013). "Anaerobic fermentation of glycerol: A platform for renewable fuels and chemicals." Trends in Biotechnology **31**(1): 20-28.
- Corchete, S. (1986). El Agricultor ante la conservación y mejora del Medio Ambiente. Madrid. **13**.
- Chen, J. L., R. Ortiz, T. W. J. Steele and D. C. Stuckey (2014). "Toxicants inhibiting anaerobic digestion: A review." Biotechnology Advances **32**(8): 1523-1534.
- Chen, Y., J. J. Cheng and K. S. Creamer (2008). "Inhibition of anaerobic digestion process: A review." Bioresource Technology **99**(10): 4044-4064.
- de Ridder, M., S. de Jong, J. Polchar and S. Lingemann (2012). Risks and opportunities in the global phosphate rock market. The Hague, The Netherlands, The Hague Centre for Strategic Studies (HCSS).
- Decamp, O., A. Warren and R. Sanchez (1999). "The role of ciliated protozoa in subsurface flow wetlands and their potential as bioindicators." Water Science and Technology **40**(3): 91-98.
- Decreto 02/2012 (2012). Promoción de Inversiones. Uruguay.
- Decreto 173/2010 (2010). Microgeneración de Energía. Uruguay.
- Decreto 182/2013 (2013). Reglamentación sobre la Gestión de Residuos Sólidos Industriales y Asimilados. Uruguay.
- Decreto 253/1979 (1979). Control de efluentes líquidos Uruguay.
- Decreto 405/2008 (2008). Uso responsable y sostenible de suelos. Uruguay.
- DIEA-MGAP (2011). Censo general agropecuario. Montevideo.
- DIEA-MGAP (2012). Anuario Estadístico Agropecuario Uruguay.
- DNE-MIEM (2008). Política Energética 2005-2030. Uruguay.
- Donoso-Bravo, A., J. Mailier, C. Martin, J. Rodríguez, C. A. Aceves-Lara and A. V. Wouwer (2011). "Model selection, identification and validation in anaerobic digestion: A review." Water Research **45**: 5347-5364.
- Ekama, G. (2015). Ánaerobic digestion - Lecture notes. Industrial effluents treatment and residuals Unesco-IHE. Delft.
- Ekama, G. A., P. L. Dold and G. R. Marais v (1986). "Procedures for determining influent COD fractions and the maximum specific growth rate of heterotrophs in activated sludge systems." Water Science and Technology **18**(6): 91-114.

- Enzinger, R. M. and R. C. Cooper (1976). "Role of bacteria and protozoa in the removal of *Escherichia coli* from estuarine waters." Applied and Environmental Microbiology **31**(5): 758-763.
- Escobar, A., H. Messa, C. Ruiz-Silvera and J. Rodríguez (1998). Proyecto de Establecimiento y evaluación de un Modelo Físico de Agricultura Tropical Sostenible. Agricultura Tropical Sostenible. Experiencias y desafíos para el tercer milenio. CIARA. Caracas, Fundación Polar 65-72.
- FAO (2014). Desafíos para el desarrollo sostenible y la adaptación al cambio climático en América Latina y el Caribe Conferencia Regional de la FAO para América Latina y el Caribe. Chile.
- Fernández, A., C. Tejedor and A. Chordi (1992). "Influence of pH on the elimination of fecal coliform bacteria in waste stabilization ponds." Water, Air, and Soil Pollution **63**(3): 317-320.
- Ferrer, I., F. Vázquez and X. Font (2010). "Long term operation of a thermophilic anaerobic reactor: Process stability and efficiency at decreasing sludge retention time." Bioresource Technology **101**(9): 2972-2980.
- Field, J. and R. Sierra (1989). Waste characteristics and factors affecting reactor performance. International course on anaerobic wastewater treatment. D. w. p. control. Wageningen, UNESCO-IHE and Agricultural University of Wageningen.
- Filguiera, S. (20-08-2013). Preocupa al sector lechero exigencias de DINAMA. El Espectador. Montevideo.
- Fisher, J. and M. C. Acreman (2004). "Wetland nutrient removal: A review of the evidence." Hydrology and Earth System Sciences **8**(4): 673-685.
- Foxon, K. M., S. Pillay, T. Lalbahadur, N. Rodda, F. Holder and C. A. Buckley (2004). "The anaerobic baffled reactor (ABR): An appropriate technology for on-site sanitation." Water SA **30**(5): 44-50.
- González, M. (22-04-2009). Migraciones internas. Universia Uruguay.
- Grimm, A. M. (2011). "Interannual climate variability in South America: Impacts on seasonal precipitation, extreme events, and possible effects of climate change." Stochastic Environmental Research and Risk Assessment **25**(4): 537-554.
- Gutierrez, G. (02-03-2012). Impuesto a la concentración de la tierra es inconstitucional, según experto tributario. El Observador. Uruguay.
- Gutierrez, G. (05-12-2014). Aprueban el nuevo impuesto al campo. El País. Uruguay.
- Haroon, M. F., S. Hu, Y. Shi, M. Imelfort, J. Keller, P. Hugenholtz, Z. Yuan and G. W. Tyson (2013). "Anaerobic oxidation of methane coupled to nitrate reduction in a novel archaeal lineage." Nature **500**(7464): 567-570.
- He, S., Q. Niu, H. Ma, Y. Zhang and Y. Y. Li (2015). "The treatment performance and the bacteria preservation of anammox: A review." Water, Air, and Soil Pollution **226**(5).
- Henze, M., M. C. van Loosdrecht, G. Ekama and D. Brdjanovic (2011). Biological Wastewater Treatment: Principles, modelling and design London, IWA Publishing.
- IDB (2014). Uruguay, el pequeño país que está liderando una gran revolución energética. Blog Inter-American Development Bank.
- Ikumi, D. S., T. H. Harding and G. A. Ekama (2014). "Biodegradability of wastewater and activated sludge organics in anaerobic digestion." Water Research **56**: 267-279.
- INE (2013). Uruguay en cifras 2013. Uruguay.
- INIA-GRAS (2011). Caracterización agroclimática del Uruguay 1980-2009.
- Joye, S. B. (2012). "Microbiology: A piece of the methane puzzle." Nature **491**(7425): 538-539.
- Karl, T. R. and K. E. Trenberth (2003). "Modern Global Climate Change." Science **302**(5651): 1719-1723.



- Keane, D. A., K. G. McGuigan, P. F. Ibáñez, M. I. Polo-López, J. A. Byrne, P. S. M. Dunlop, K. O'Shea, D. D. Dionysiou and S. C. Pillai (2014). "Solar photocatalysis for water disinfection: Materials and reactor design." Catalysis Science and Technology **4**(5): 1211-1226.
- Keymer, U. and A. Schilcher (2003). Biogasanlagen: Berechnung der Gasausbeute von Kosubstraten. bayrische Landesanstalt für Landwirtschaft Biogas plants: calculation of the gas yield of co-substrates, Bavarian State Institute for Agriculture.
- Khair, S. M., S. Mushtaq, R. J. Culas and M. Hafeez (2012). "Groundwater markets under the water scarcity and declining watertable conditions: The upland Balochistan Region of Pakistan." Agricultural Systems **107**: 21-32.
- Kutikova, L. A. (2000). Variability in obligatory parthenogenetic rotifers (Rotifera, Bdelloida). A. R. o. t. Z. I. RAS. Russia, Zoological Institute, Russian Academy of Sciences. **1**.
- Kythreotou, N., G. Florides and S. A. Tassou (2014). "A review of simple to scientific models for anaerobic digestion." Renewable Energy **71**: 701-714.
- Lashof, D. A. and D. R. Ahuja (1990). "Relative contributions of greenhouse gas emissions to global warming." Nature **344**(6266): 529-531.
- Ley 18195/07 (2007). Agrocombustibles. Uruguay.
- Ley 18308/08 (2008). Ordenamiento Territorial y Desarrollo Sostenible. Uruguay.
- Liu, R., Y. Zhao, L. Doherty, Y. Hu and X. Hao (2015). "A review of incorporation of constructed wetland with other treatment processes." Chemical Engineering Journal **279**: 220-230.
- Lo, K. V., W. Y. Chen and P. H. Liao (1986). "Mesophilic digestion of screened dairy manure using anaerobic rotating biological contact reactor." Biomass **9**(2): 81-92.
- Ma, F. and M. A. Hanna (1999). "Biodiesel production: A review." Bioresource Technology **70**(1): 1-15.
- Martins, C. I. M., E. H. Eding, M. C. J. Verdegem, L. T. N. Heinsbroek, O. Schneider, J. P. Blancheton, E. R. d'Orbecastel and J. A. J. Verreth (2010). "New developments in recirculating aquaculture systems in Europe: A perspective on environmental sustainability." Aquacultural Engineering **43**(3): 83-93.
- Mata-Alvarez, J., J. Dosta, M. S. Romero-Güiza, X. Fonoll, M. Peces and S. Astals (2014). "A critical review on anaerobic co-digestion achievements between 2010 and 2013." Renewable and Sustainable Energy Reviews **36**: 412-427.
- Mazzeo, N. (2002). "Eutrofización: causas, consecuencias y manejo." 39-55.
- Mekonnen, M. and A. Hoekstra (2012). "A Global Assessment of the Water Footprint of Farm Animal Products." Ecosystems **15**(3): 401-415.
- Méndez, R. (2013). La Revolución Energética. Enlaces. Uruguay.
- Mentz, M. B., J. M. Wiest and P. C. Gonçalves (2004). "Viability of bovine's strongyloidea eggs in a system of anaerobic biodigestion." Parasitologia Latinoamericana **59**(3-4): 148-152.
- MGAP. (2015). "Lanzamiento de Planes para la Lechería Sostenible (PLS)." from <https://www.youtube.com/watch?v=cpkCNdHNaV8>.
- MGAP, MVOTMA and MIEM (2012). Towards a green economy in Uruguay: stimulating sustainable production practices and low-emission technologies in prioritized sectors. Uruguay, Fondo para el Medio Ambiente (GEF 4890-UNIDO/ONU).
- MGAP(a) (2013). Proyecto "Ganaderos Familiares y Cambio Climático". Uruguay, Banco Interamericano de Desarrollo.
- MGAP(b) (2013). Proyecto "Desarrollo Agropecuario y Cambio Climático". Uruguay, Banco Mundial (8099-UY).
- Millipore (2014). Spectroquant move 100 operating manual.
- Moncayo, G. (2013). Biodigestores. Manual práctico de diseño.

- MVOTMA (2004). Evolución de emisiones de gases de efecto invernadero 1990-2004. Uruguay.
- MVOTMA (2013). Plan de acción para la protección de la calidad ambiental y la disponibilidad de las fuentes de agua potable. Montevideo.
- Nieto, A., B. Murillo, E. Troyo, J. Larinaga and L. Garcia (2002). "El uso de compostas como alternativa ecológica para la producción sostenible del chile (*Capsicum annum* L.) en zonas áridas." Interciencia **27**: 417-421.
- OECD (2008). OECD Environmental Outlook to 2030. France.
- Pavlostathis, S. G. and E. Giraldo-Gomez (1991). "Kinetics of anaerobic treatment." Water Science and Technology **24**(8): 35-59.
- Peralta-Alba, J. M. (1990). Agentes erosivos y tipos de erosión. INIA - Carilanca. Chile.
- Perez-Gavilan, P. and G. Viniegra (2008). Potencial del uso de estiércol para alimentación Universidad Nacional Autónoma de México.
- Pritchard, D. L., N. Penney, M. J. McLaughlin, H. Rigby and K. Schwarz (2010). "Land application of sewage sludge (biosolids) in Australia: Risks to the environment and food crops." Water Science and Technology **62**(1): 48-57.
- Proakis, E. (2003). "Pathogen removal in constructed wetlands focusing on biological predation and marine recreational water quality." Proceedings of the Water Environment Federation **2003**(9): 310-332.
- Quispe, C. A. G., C. J. R. Coronado and J. A. Carvalho Jr (2013). "Glycerol: Production, consumption, prices, characterization and new trends in combustion." Renewable and Sustainable Energy Reviews **27**: 475-493.
- Rajeshwari, K. V., M. Balakrishnan, A. Kansal, K. Lata and V. V. N. Kishore (2000). "State-of-the-art of anaerobic digestion technology for industrial wastewater treatment." Renewable & sustainable energy reviews **4**(2): 135-156.
- RAPAL Uruguay (2010). Contaminación y eutrofización del agua. Impactos del modelo de agricultura industrial. Uruguay.
- Reijntjes, C., B. Haverkort and A. Waters-Bayer (1992). Farming for the future: An introduction to lowexternal input and sustainable agriculture. The Information Centre for Low-External-Input and Sustainable Agriculture.
- Resolución Ministerial 159/2015 (2015). Planes de lechería Sostenible. Uruguay.
- Rittman, B. E. and P. L. McCarty (2001). Stoichiometry and bacterial energetics. Environmental Biotechnology - Principles and applications New York, McGrall-Hill.
- Robra, S., R. Serpa da Cruz, A. M. de Oliveira, J. A. A. Neto and J. V. Santos (2010). "Generation of biogas using crude glycerin from biodiesel production as a supplement to cattle slurry." Biomass and Bioenergy **34**(9): 1330-1335.
- Rojas, D. (20-05-2014). Advierten por gravísima contaminación del Río Negro. El País. Montevideo.
- Rosa, A. P., L. C. S. Lobato, C. A. L. Chernicharo, D. C. R. B. Martins, F. M. Maciel and J. M. Borges (2012). "Improving performance and operational control of UASB reactors via proper sludge and scum discharge routines." Water Practice and Technology **7**(3).
- Saeed, T. and G. Sun (2012). "A review on nitrogen and organics removal mechanisms in subsurface flow constructed wetlands: Dependency on environmental parameters, operating conditions and supporting media." Journal of Environmental Management **112**: 429-448.
- Sakar, S., K. Yetilmezsoy and E. Kocak (2009). "Anaerobic digestion technology in poultry and livestock waste treatment - A literature review." Waste Management and Research **27**(1): 3-18.
- Salome, A. A. (2015). Sludge management - Lecture notes. Industrial effluent treatment and residues. Unesco-IHE. Delft.

- Sander, R. (1999). Compilation of Henry's law constants for inorganic and organic species of potential importance in environmental chemistry. Germany, Max-Planck Institute of Chemistry.
- Seoáñez, M. (1998). Medio Ambiente y Desarrollo. Manual de Gestión de los Recursos en Función del Medio Ambiente. Madrid. España., Mundi-Prensa.
- Shin, H. S. and Y. C. Song (1995). "A model for evaluation of anaerobic degradation characteristics of organic waste: focusing on kinetics, rate-limiting step. ." Environmental Technology(16): 775-784.
- Silva, P. (09-01-2013). Amenaza de erosión obliga a cuidar los suelos. El Observador. Montevideo.
- Sötemann, S. W., N. E. Ristow, M. C. Wentzel and G. A. Ekama (2005). "A steady state model for anaerobic digestion of sewage sludges." Water SA **31**(4): 511-528.
- Souza, C. L., S. Q. Silva, S. F. Aquino and C. A. L. Chernicharo (2006). "Production and characterization of scum and its role in odour control in UASB reactors treating domestic wastewater." Water Science and Technology **54**: 201-208.
- Tamkin, A., J. Martin, J. Castano, R. Richard Ciotola, R. Rosenblumb and M. Bisesi (2015). "Impact of organic loading rates on the performance of variable temperature biodigesters." Ecological Engineering **78**: 87-94.
- Tanner, C. C., J. D'Eugenio, G. B. McBride, J. P. S. Sukias and K. Thompson (1999). "Effect of water level fluctuation on nitrogen removal from constructed wetland mesocosms." Ecological Engineering **12**(1-2): 67-92.
- Tarlera, S., M. C. Capurro, P. Irisarri, A. F. Scavino, G. Cantou and A. Roel (2016). "Yield-scaled global warming potential of two irrigation management systems in a highly productive rice system." Scientia Agricola **73**: 43-50.
- Tauseef, S. M., T. Abbasi and S. A. Abbasi (2013). "Energy recovery from wastewaters with high-rate anaerobic digesters." Renewable and Sustainable Energy Reviews **19**: 704-741.
- Texo, J. P., C. I. Bentancur and J. P. Duque (2009). Perspectivas generales de desarrollo de la industria de biocombustibles en Uruguay, UdelaR.
- Thorpe, B. (1999). Citizen's Guide to Clean Production. Produced for the Clean Production Network. Massachusetts.
- Timmerman, M., E. Schuman, M. Van Eekert and J. Van Riel (2015). "Optimizing the performance of a reactor by reducing the retention time and addition of glycerin for anaerobically digesting manure." Environmental Technology **36**(10): 1223-1236.
- Tinker, P. B., J. S. I. Ingram and S. Struwe (1996). "Effects of slash-and-burn agriculture and deforestation on climate change." Agriculture, Ecosystems and Environment **58**(1): 13-22.
- Traversi, D., S. Bonetta, R. Degan, S. Villa, A. Porfido, M. Bellerio, E. Carraro and G. Gilli (2013). "Environmental Advances Due to the Integration of Food Industries and Anaerobic Digestion for Biogas Production: Perspectives of the Italian Milk and Dairy Product Sector." Bioenergy Research **6**(3): 851-863.
- UNEP (2009). Producción más limpia. Un paquete de capacitación.
- Uruguay-XXI (2012). Sector lácteo en Uruguay Montevideo.
- Uruguay-XXI (2013). Energías Renovables. Instituto de Promoción de Inversiones y Exportaciones. Uruguay.
- Uruguay-XXI (2015). Sector lácteo en Uruguay. Montevideo.
- UTE (2016). Pliego tarifario 2016. Uruguay.
- Van der Lier, J. (2015). Anaerobic reactor technologies - Lecture notes. Resourced oriented to wastewater treatment and sanitation. Unesco-IHE. Delft.
- Van der Steen, P. (2015). Wastewater Satbilization Ponds - Lecture notes. Resource oriented to wastewater treatment and sanitation. Unesco-IHE. Delft, IHE-Unesco.

- Viñas, M. and S. Gutiérrez (2004). Estimación de los parámetros nacionales básicos para el procesamiento y utilización de los residuos sólidos y líquidos de tambos. Uruguay, INIA-FPTA N°138.
- Wang, X., X. Lu, F. Li and G. Yang (2014). "Effects of temperature and Carbon-Nitrogen (C/N) ratio on the performance of anaerobic co-digestion of dairy manure, chicken manure and rice straw: Focusing on ammonia inhibition." PLoS ONE **9**(5).
- WHO (1989). Guidelines for the safe use of wastewater and excreta in agriculture and aquaculture.
- Zinola, G. (2015). Valorization of wastewater from dairy farms using low-cost technologies. Uruguay, ANII. **USD 70,000**.

## CHAPTER 7

# Appendices

### Appendix A : Photos of experiments

#### AB assay



**Figure 47.** Batch anaerobic digestion process to the AB test. From left to right: Blank, GLY10+R and EFF conditions.

#### Lab-scale system

The lab-scale system was built based in the descriptions presented in the correspondent section (3.2.). Some images were presented below to clarify the operation of the system (Figure 48).

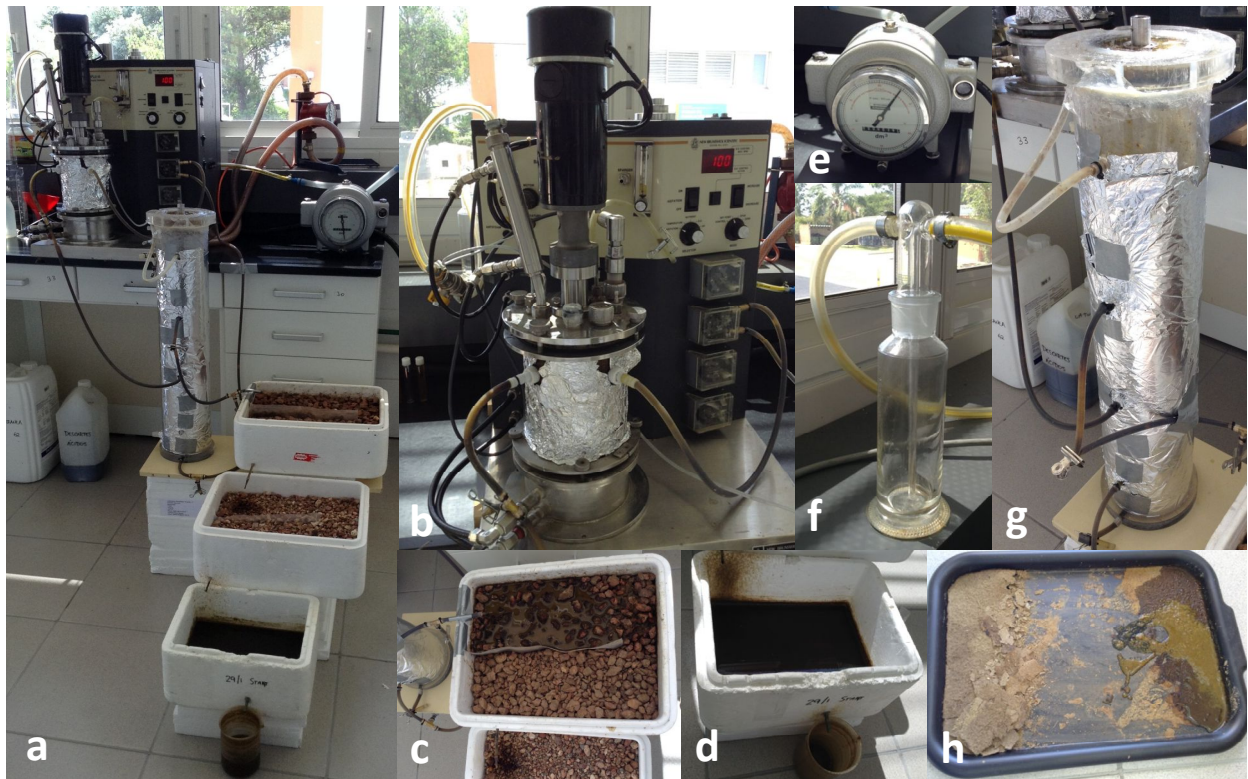

**Figure 48.** Lab-scale system installed. a. Complete system. b. Bioflo III reactor. c. Stone filters. d. Pond. e. Biogas flow meter. f. Gas tramp. g. Settler. h. Sludge drying bed.

The anaerobic sections were covered using foil because some coloured organisms grown in the walls forming pink spots that were eliminated after the covering (Figure 49).



**Figure 49.** Pink growth inside of the settler.



The biogas production in the reactor and in the settler produced that the sludge decreased its density and this float in the liquid phase. The scum formed in the top of the reactor and in the settler was removed by the increment of RPM in the reactor (from 100 to 250), and by the mix of the settler manually (Figure 50). This scum formation, mainly in the settler, produced that some biogas was not release to the gas phase and the supernatant of the settler had sludge some days. These factors produced that the COD mass balances did not close completely in the beginning of the experiment. As a consequence, 30 min after measures the scum removal was done to improve the data collection.

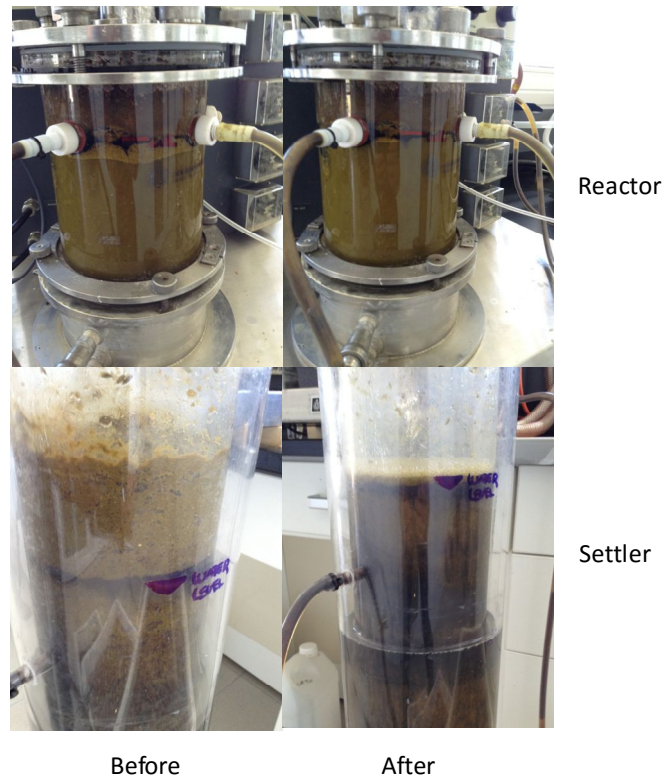

**Figure 50.** Scum formation in the reactor and settler.

The figure below represent the appearance of the samples took from the system in steady state condition (Figure 51).



**Figure 51.** Samples for the last steady state condition (GLY10+R condition).

## Appendix B : Mass balances in the lab-scale digester

The lab-scale system was an ACP and composed by a CSTR and a settler in order to ensure the biomass recycle in the system and the proper solids behaviour to hydrolyse the  $X_S$  (Figure 21). The HRT was defined by the ratio between the volume of the system ( $V_T = V_D + V_S$ ) and the influent flow ( $Q_i$ ). However, the SRT was disengaged to the HRT allowing work with low  $V$  and high SRT for the hydrolysis process.

### COD<sub>B</sub> mass balance for the stoichiometry approach

The reminder biodegradable COD (COD<sub>B</sub>) could be expressed based in the mass balance of COD<sub>B</sub> on CV 1 for the steady state conditions (Figure 22).

$$Q_i \text{COD}_{B,i} = (Q_i \text{COD}_{B,i} - F \text{COD}_B)(1 - E) + Q_i \text{COD}_{T,i} E + Q_e \text{COD}_{B,e} + Q_W \text{COD}_{B,W}$$

Inlet flux

Biogas production

Biomass production

Outlet flux

Where:

$$\begin{aligned} & \text{COD}_{S,e} \text{ assumed as unbiodegradable} \\ & \text{COD}_{B,i} = Q_i (1 - f_{\text{upi}}) \text{COD}_{T,i} - Q_e \text{COD}_{S,e} \\ & \text{COD}_{B,e} = \text{COD}_{X,e} (1 - f_{\text{AD}}) \\ & \text{COD}_{B,W} = \text{COD}_{T,W} (1 - f_{\text{AD}}) \\ & f_{\text{AD}} = \text{fraction of unbiodegradable endogenous residues (-)} \end{aligned}$$

After substitution and organizing, the COD<sub>B</sub> can be expressed by the Equation 31. This equation allowed the calculation of the reminder biodegradable COD from the experimental data and with the assumption of a value of the  $f_{\text{AD}}$ .

$$\begin{aligned} & Q_i (1 - f_{\text{upi}}) \text{COD}_{T,i} - Q_e \text{COD}_{S,e} = \\ & \quad \{ [Q_i (1 - f_{\text{upi}}) \text{COD}_{T,i} - Q_e \text{COD}_{S,e}] - \text{COD}_B \} (1 - E) + Q_i \text{COD}_{T,i} E \\ & \quad + Q_e (\text{COD}_{T,e} - \text{COD}_{S,e}) (1 - f_{\text{AD}}) + Q_W \text{COD}_{T,W} (1 - f_{\text{AD}}) \end{aligned}$$

$$(31) \quad \text{COD}_B = \frac{1}{(1 - E)} \{ E \{ Q_i \text{COD}_{T,i} [(1 - f_{\text{upi}}) + 1] - Q_e \text{COD}_{S,e} \} - Q_e (\text{COD}_{T,e} - \text{COD}_{S,e}) (1 - f_{\text{AD}}) + Q_W \text{COD}_{T,W} (1 - f_{\text{AD}}) \}$$

### Hydrolysis/acidogenic process

According with the limiting step of the hydrolysis of the  $X_S$  into  $S_S$  by the  $Z_{\text{AD}}$ , the Monod kinetics (Equation 39) and 1<sup>ST</sup> order specific (Equation 40) was used to predict the behaviour of the hydrolysis and the acidogenic processes (Pavlostathis and Giraldo-Gomez 1991).

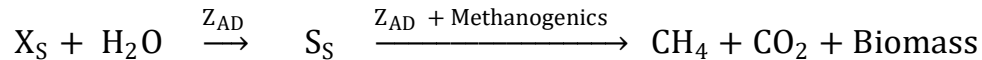



$$(39) \quad r_H = \mu Z_{AD} = \frac{\mu_{AD}}{Y_{AD}} Z_{AD} = \frac{\mu_m \text{COD}_B}{K_S + \text{COD}_B} Z_{AD}$$

$$(40) \quad r_H = \mu Z_{AD} = \frac{\mu_{AD}}{Y_{AD}} Z_{AD} = K_H \text{COD}_B Z_{AD}$$

Where:

- $r_H$  = hydrolysis rate (gCOD<sub>B</sub>/L.d)
- $\mu$  = specific hydrolysis rate (1/d)
- $\mu_{AD}$  = growth rate of acidogenic (1/d)
- $\mu_m$  = maximum specific hydrolysis rate of acidogenic (1/d)
- $K_S$  = half saturation concentration of COD<sub>B</sub> (gCOD<sub>B</sub>/L)
- $K_H$  = hydrolysis constant of acidogenic (L/gCOD<sub>B</sub>.d)
- $Y_{AD}$  = acidogen biomass yield (gCOD<sub>BIOM</sub>/gCOD<sub>B</sub>)

### Mass balances

#### Acidogen biomass - $Z_{AD}$

According with the growth and death of the  $Z_{AD}$  in the system, the mass balance of the active biomass for the hydrolysis reaction on CV 1 was the following (Equation 42).

$$V_T dZ_{AD} = \underbrace{Q_i Z_{AD,i} dt}_{\text{Inlet}} - \underbrace{Q_e Z_{AD,e} dt - Q_W Z_{AD,W} dt}_{\text{Outlet}} + \underbrace{(Y_{AD} r_H)}_{\text{Gains by Growth}} - \underbrace{b_{AD} Z_{AD}}_{\text{Loss by Death}} V_T dt$$

Where:

- $b_{AD}$  = decay rate (1/d)
- $Z_{AD,i}$  = influent acidogenic biomass concentration assumed as 0

Dividing by  $Z_{AD} \cdot V_T \cdot dt$ .

$$(41) \quad \frac{1}{Z_{AD}} \frac{dZ_{AD}}{dt} = \frac{Y_{AD} r_H}{Z_{AD}} - b_{AD} - \frac{Q_e Z_{AD,e}}{V_T Z_{AD}} - \frac{Q_W Z_{AD,W}}{V_T Z_{AD}}$$

Additionally, the  $FZ_{AD} = Q_i Z_{AD} = Q_e Z_{AD,e} + Q_W Z_{AD,W}$  and  $\text{HRT} = V_T/Q_i$ .

$$(42) \quad \frac{1}{Z_{AD}} \frac{dZ_{AD}}{dt} = \frac{Y_{AD} r_H}{Z_{AD}} - b_{AD} - \frac{1}{\text{HRT}}$$

#### Reminder biodegradable COD - $\text{COD}_B$

The COD consumption by the biological process was used to define the mass balance of the biodegradable COD (COD<sub>B</sub>) on CV 1 was the following (Equation 45).

$$V_T d\text{COD}_B = \underbrace{Q_i \text{COD}_{B,i} dt}_{\text{Inlet}} - \underbrace{Q_e \text{COD}_{B,e} dt - Q_W \text{COD}_{B,W} dt}_{\text{Outlet}} + \underbrace{[(1 - f_{AD}) b_{AD} Z_{AD}]}_{\text{Gains by endogenous residues}} - \underbrace{r_H}_{\text{Loss by hydrolysis}} V_T dt$$

Where:

$$\begin{aligned} \text{COD}_{S,e} & \text{ assumed as unbiodegradable} \\ \text{COD}_{B,i} & = Q_i (1-f_{upi}) \text{COD}_{T,i} - Q_e \text{COD}_{S,e} \\ \text{COD}_{B,e} & = \text{COD}_{X,e} (1-f_{AD}) \\ \text{COD}_{B,W} & = \text{COD}_{T,W} (1-f_{AD}) \\ f_{AD} & = \text{fraction of unbiodegradable endogenous residues (-)} \end{aligned}$$

Dividing by  $V_T \cdot dt$  and  $\text{HRT} = V_T/Q_i$ . Additionally, the  $\text{FCOD}_B = Q_i \text{COD}_B = Q_e \text{COD}_{B,e} + Q_W \text{COD}_{B,W}$ .

$$(43) \quad \frac{d\text{COD}_B}{dt} = \frac{\text{COD}_{B,i}}{\text{HRT}} - \frac{Q_e \text{COD}_{B,e}}{Q_i \text{HRT}} - \frac{Q_W \text{COD}_{B,W}}{Q_i \text{HRT}} + (1 - f_{AD}) b_{AD} Z_{AD} - r_H$$

$$(45) \quad \frac{d\text{COD}_B}{dt} = \frac{1}{\text{HRT}} [Q_i (1 - f_{upi}) \text{COD}_{T,i} - Q_e \text{COD}_{S,e} - \text{COD}_B] + (1 - f_{AD}) b_{AD} Z_{AD} - r_H$$

Where:

$$\Delta \text{COD}_B = Q_i (1-f_{upi}) \text{COD}_{T,i} - Q_e \text{COD}_{S,e} - \text{COD}_B$$

### Biogas production - $S_m$

The  $S_m$  expression was based in the mass balance of  $S_m$  on CV 1. The production of methane was assumed as the reminder part of the  $\text{COD}_{B,i}$  ( $\Delta \text{COD}_B$ ) that was not consumed in the growth of acidogen and methanogenic biomass (1-E) (Equation 46).

$$V_T dS_m = \boxed{Q_i S_{m,i} dt} - \boxed{Q_e S_{m,e} dt - Q_W S_{m,W} dt} + \boxed{(1 - E) r_H V_T dt}$$

Inlet
Outlet
Methane production

Considering  $S_{m,i} = S_{m,W} \approx 0$  and dividing by  $V_T \cdot dt \cdot S_m$ .

$$(46) \quad \frac{1}{S_m} \frac{dS_m}{dt} = \frac{(1 - E) r_H}{S_m} - \frac{Q_e S_{m,e}}{V_T S_m}$$

The  $S_m$  produced was distributed in the gas and in the liquid phases following the Henry's law. The  $S_m = S_{m,e} + S_{m,g}$  if the  $S_{m,W}$  was negligible. So,  $S_m/S_{m,e} = 1 + S_{m,g}/S_{m,e}$  and the ratio between the gas phase concentration and the liquid phase concentration is the reported value of the Henry's constant. Consequently,  $S_m/S_{m,e} = 1 + H^{cc}$  and the  $S_m$  mass balance can be expressed as the follow equation 47 ( $H^{cc} = 31.4$  at  $25^\circ\text{C}$ )(Sander 1999)

$$(47) \quad \frac{1}{S_m} \frac{dS_m}{dt} = \frac{(1 - E) r_H}{S_m} - \frac{Q_e}{V_T (1 + H^{cc})}$$

### Steady state condition of the mass balances

In the steady state conditions the  $dZ_{AD}/dt = 0$ ,  $d\text{COD}_B/dt = 0$  and  $dS_m/dt = 0$  by its definition. According with the equation 42, an expression of the  $r_H$  could be defined (Equation 48)

$$(42) \quad \frac{1}{Z_{AD}} \frac{dZ_{AD}}{dt} = \frac{Y_{AD} r_H}{Z_{AD}} - b_{AD} - \frac{1}{HRT} = 0$$

$$(48) \quad r_H = \frac{Z_{AD}}{Y_{AD}} \left( b_{AD} + \frac{1}{HRT} \right)$$

In order to define an **expression for the  $Z_{AD}$** , from equation 45 the equation 49 was defined.

$$(45) \quad \frac{dCOD_B}{dt} = \frac{1}{HRT} [Q_i(1 - f_{upi})COD_{T,i} - Q_e COD_{S,e} - COD_B] + (1 - f_{AD})b_{AD} Z_{AD} - r_H = 0$$

And consequently:

$$(49) \quad r_H = \frac{1}{HRT} [Q_i(1 - f_{upi})COD_{T,i} - Q_e COD_{S,e} - COD_B] + (1 - f_{AD})b_{AD} Z_{AD}$$

Combining equations 48 and 49, the following equation 50 represent the  $Z_{AD}$  and depends of the  $\Delta COD_B$  consumed by the biological process and finally of the reminder  $COD_B$ .

$$\begin{aligned} \frac{Z_{AD}}{Y_{AD}} \left( b_{AD} + \frac{1}{HRT} \right) &= \frac{1}{HRT} [Q_i(1 - f_{upi})COD_{T,i} - Q_e COD_{S,e} - COD_B] + (1 - f_{AD})b_{AD} Z_{AD} \\ Z_{AD} \left[ \frac{b_{AD}}{Y_{AD}} + \frac{1}{HRT Y_{AD}} - (1 - f_{AD})b_{AD} \right] &= \frac{1}{HRT} [Q_i(1 - f_{upi})COD_{T,i} - Q_e COD_{S,e} - COD_B] \\ (50) \quad Z_{AD} &= \frac{Y_{AD} [Q_i(1 - f_{upi})COD_{T,i} - Q_e COD_{S,e} - COD_B]}{HRT \left[ b_{AD} - Y_{AD} b_{AD} (1 - f_{AD}) + \frac{1}{HRT} \right]} \quad \text{in gCOD/d} \end{aligned}$$

Based in Monod kinetic, in order to determine an **expression for the  $COD_B$**  (Equation 51), replacing  $r_H$  of equation 39 in the equation 48:

$$\begin{aligned} \frac{\mu_m COD_B}{K_S + COD_B} Z_{AD} &= \frac{Z_{AD}}{Y_{AD}} \left( b_{AD} + \frac{1}{HRT} \right) \\ \mu_m COD_B &= \frac{b_{AD} K_S}{Y_{AD}} + \frac{K_S}{HRT Y_{AD}} + \frac{b_{AD} COD_B}{Y_{AD}} + \frac{COD_B}{HRT Y_{AD}} \\ (51) \quad COD_B &= \frac{K_S \left( b_{AD} + \frac{1}{HRT} \right)}{\mu_m Y_{AD} - \left( b_{AD} + \frac{1}{HRT} \right)} \quad \text{in gCOD/L} \end{aligned}$$

Based in 1<sup>ST</sup> order specific, in order to determine an **expression for the  $COD_B$**  (Equation 52), replacing  $r_H$  of equation 40 in the equation 48:

$$K_H COD_B Z_{AD} = \frac{Z_{AD}}{Y_{AD}} \left( b_{AD} + \frac{1}{HRT} \right)$$

$$(52) \quad \text{COD}_B = \frac{1}{Y_{AD} K_H} \left( b_{AD} + \frac{1}{\text{HRT}} \right) \quad \text{in gCOD/L}$$

The equations 51 and 52 were compared with the equation 31 in order to compare the  $\text{COD}_B$  from the kinetics models with the  $\text{COD}_B$  measured.

The  **$S_m$  expression** depends of the kinetics models to be applied (Equation 53). These equations were obtained from the equation 47 considering the steady state conditions.

$$(47) \quad \frac{1}{S_m} \frac{dS_m}{dt} = \frac{(1-E) r_H}{S_m} - \frac{Q_e}{V_T(1+H^{cc})} = 0$$

$$(53) \quad S_m = \frac{(1-E) V_T(1+H^{cc}) r_H}{Q_e}$$

The equation 53 depends of  $r_H$ . Substituting by the Monod kinetics (Equation 39) the equation 54 was obtained.

$$(54) \quad S_m = \frac{V_T (1-E) (1+H^{cc})}{Q_e} \frac{\mu_m \text{COD}_B}{(K_S + \text{COD}_B)} Z_{AD} \quad \text{in gCOD/d}$$

In the other hand, substituting by 1<sup>ST</sup> order specific (Equation 40) kinetics equation, the  $S_m$  expression was developed (Equations 55).

$$(55) \quad S_m = \frac{V_T (1-E) (1+H^{cc})}{Q_e} K_H \text{COD}_B Z_{AD} \quad \text{in gCOD/d}$$

The equations 54 and 55 were compared with the  $S_m$  measured experimentally to determine which model had the best fit with the reality.

# Appendix C : AB test results

Time (h)		Temp. (°C)	Control				EFF								GLY10+R											
(hours)	(days)		pH (-)	Height (cm)	Biogas volume at 30°C (mL)	VFA (meq/L)	pH (-)	Height (cm)	Biogas volume at 30°C (mL)	VFA (meq/L)	Corrected Biogas volume (mL)	Methane (mgCOD)	VFA corrected (gCOD/L)	Cumulative Sm (gCOD)	COD-VFA produced (gCOD)	pH (-)	Height (cm)	Biogas volume at 30°C (mL)	VFA (meq/L)	Corrected Biogas volume (mL)	Methane (mgCOD)	VFA corrected (gCOD/L)	Cumulative Sm (gCOD)	COD-VFA produced (gCOD)		
0,0	0,00	28,5	7,42	0,0	0,00	19,75	7,50	0,0	0,00	39,68	0,00	0,0	2,147	0,000	0,00	7,13	0,0	0,00	44,97	0,00	0,0	2,287	0,000	0,00		
4,0	0,17	28,1		-1,3	-1,57			1,8	2,17	3,74	3,3			0,003			29,9	36,10	37,67		57,4	0,057				
8,0	0,33	28,1		0,0	0,00			4,7	5,67	5,67	8,5			0,012			64,5	77,88	77,88		118,6	0,176				
13,5	0,56	28,0		-1,6	-1,94			11,2	13,57	15,51	20,4			0,032			70,3	85,19	87,13		132,6	0,309				
16,5	0,69	28,4		1,2	1,43			7,4	8,84	7,41	13,3			0,046			65,3	78,01	76,58		116,6	0,425				
18,0	0,75	28,7		3,0	3,55			17,4	20,57	17,4	31,0			0,077			59,2	69,99	66,44		101,1	0,526				
19,0	0,79	28,6		-0,3	-0,36			16,3	19,34	19,69	29,1			0,106			48,5	57,54	57,89		88,1	0,614				
22,0	0,92	29,3		0,8	0,93			28,5	33,00	32,08	49,7			0,155			69,4	80,36	79,44		120,9	0,735				
25,0	1,04	29,6		0,2	0,23			32,5	37,25	37,02	56,1			0,212			71,9	82,42	82,19		125,1	0,860				
28,0	1,17	29,2		-2,1	-2,44			29,0	33,70	36,14	50,8			0,262			70,6	82,03	84,47		128,6	0,989				
32,5	1,35	28,7		-6,5	-7,68			40,4	47,76	55,45	71,9			0,334			70,3	83,11	90,79		138,2	1,127				
36,0	1,50	28,5		-1,3	-1,55			32,1	38,21	39,76	57,6			0,392			67,3	80,12	81,67		124,3	1,252				
38,0	1,58	28,2		-4,5	-5,41			19,6	23,58	29,00	35,5			0,427			61,2	73,63	79,05		120,3	1,372				
42,0	1,75	29,0		6,2	7,25			37,3	43,64	36,39	65,7			0,493			70,4	82,37	75,11		114,4	1,486				
44,0	1,83	29,6		4,9	5,62			23,3	26,71	21,09	40,2			0,533			58,7	67,29	61,67		93,9	1,580				
48,5	2,02	30,8		6,7	7,38			32,2	35,47	28,09	53,4			0,587			70,2	77,33	69,95		106,5	1,687				
51,0	2,13	30,2		-3,5	-3,93			41,2	46,29	50,22	69,7			0,656			68,6	77,07	81,00		123,3	1,810				
54,5	2,27	28,9		-7,5	-8,81			30,3	35,57	44,38	53,6			0,710			57,2	67,15	75,96		115,6	1,926				
59,5	2,48	28,7		-0,3	-0,35			39,7	46,93	47,29	70,7			0,781			69,3	81,93	82,28		125,3	2,051				
66,0	2,75	29,0		0,0	0,00			45,5	53,23	53,23	80,2			0,861			70,6	82,60	82,60		125,7	2,177				
68,0	2,83	29,5	7,63	3,3	3,80	23,81	7,05	18,0	20,70	16,91	31,2	2,223		0,892	2,22	6,96	16,0	18,40	14,61	61,36	22,2	3,405		3,41		
69,5	2,90	30,1		6,1	6,88			18,4	20,74	13,86	31,2			0,923			16,0	18,04	11,16		17,0	2,216				
76,5	3,19	28,7		-8,2	-9,69			37,9	44,81	54,50	67,5			0,991			46,8	55,33	65,02		99,0	2,315				
84,0	3,50	28,1		-4,3	-5,19			58,6	70,76	75,95	106,6			1,097			53,4	64,48	69,67		106,1	2,421				
92,0	3,83	30,0		6,2	7,01			45,2	51,12	44,11	77,0			1,174			46,3	52,36	45,35		69,0	2,490				
94,0	3,92	31,0		8,2	8,97			26,9	29,44	20,47	44,3			1,219			22,5	24,63	15,65		23,8	2,514				
97,0	4,04	31,1		1,1	1,20			34,8	37,97	36,77	57,2			1,276			29,7	32,40	31,20		47,5	2,561				
100,0	4,17	30,1		-7,5	-8,45			25,3	28,52	36,97	43,0			1,319			20,0	22,54	31,00		47,2	2,609				
106,5	4,44	28,5		-6,2	-7,38			43,2	51,43	58,81	77,5			1,396			48,2	57,38	64,76		98,6	2,707				
111,0	4,63	29,3		1,3	1,51			40,3	46,67	45,16	70,3			1,467			43,6	50,49	48,98		74,6	2,782				
116,0	4,83	30,3		3,8	4,26			43,6	48,82	44,57	73,5			1,540			45,7	51,17	46,92		71,4	2,853				
119,0	4,96	31,6		7,7	8,27			30,2	32,43	24,16	48,8			1,589			32,5	34,90	26,63		40,5	2,894				
121,0	5,04	31,8		0,8	0,85			19,8	21,13	20,27	31,8			1,621			16,6	17,71	16,86		25,7	2,919				
129,0	5,38	29,7		-9,6	-10,97			36,7	41,93	52,89	63,1			1,684			38,4	43,87	54,84		83,5	3,003				
141,0	5,88	31,7	7,56	7,3	7,81	16,28	7,20	61,7	66,04	24,69	58,23	99,5	0,906	1,783	3,13	7,08	63,9	68,39	34,18	60,58	92,2	1,623	3,095	5,03		
143,0	5,96	31,2		1,3	1,41			14,7	15,99	14,57	24,1			1,807			19,2	20,88	19,47		29,6	3,125				
149,5	6,23	30,2		-5,2	-5,84			40,8	45,84	51,68	69,0			1,876			43,7	49,10	54,94		83,6	3,208				
156,0	6,50	28,7		-7,2	-8,51			35,9	42,44	50,95	63,9			1,940			37,4	44,21	52,73		80,3	3,289				
163,0	6,79	30,7		9,8	10,83			36,4	40,23	29,40	60,6			2,001			39,8	43,99	33,16		50,5	3,339				
167,0	6,96	30,6		0,1	0,11			30,2	33,49	33,37	50,4			2,051			32,5	36,04	35,93		54,7	3,394				
191,5	7,98	29,8		-5,1	-5,81			33,8	38,48	44,29	58,0			2,109			55,0	62,62	68,43		104,2	3,498				
209,0	8,71	29,3	7,56	-1,3	-1,51	14,81	7,17	30,2	34,97	36,48	52,7	0,268		2,162	3,40	7,11	31,8	36,82	21,16		38,33	3,584	0,576	5,60		
211,0	8,79	29,8		1,2	1,37			7,9	8,99	7,63	13,5			2,176			12,5	14,23	12,87		19,6	3,576				
234,0	9,75	29,5		-2,4	-2,76			14,0	16,10	18,86	24,3			2,200			11,9	13,69	16,45		25,0	3,601				
261,5	10,90	29,7		0,4	0,46			17,0	19,42	18,96	29,3			2,229			14,9	17,02	16,56		25,2	3,626				
284,0	11,83	30,5	7,41	5,2	5,78	7,69	7,09	12,8	14,24	8,14	8,45	0,048		2,251	3,45	7,12	10,5	11,68	9,77		9,0	3,635	0,189	5,79		
356,0	14,83	29,3	7,30	-4,6	-5,33	1,63	6,86	-2,3	-2,66	1,63	2,66	-4,0	0,000	2,247	3,45	7,07	0,6	0,69	1,63		6,02	3,644	0,000	5,79		
429,0	17,88	28,4	7,29	-4,0	-4,78	1,63	7,00	-6,0	-7,17	1,63	-2,39	-10,8	0,000	2,236	3,45	7,10	-1,0	-1,19	1,92		3,58	3,650	0,026	5,82		
454,0	18,92	29,8		10,8	12,30			9,2	10,47	-1,82	15,8			2,252			7,2	8,20	-4,10		-6,2	3,643				
546,0	22,75	28,1		-11,3	-13,64			-19,1	-23,06	-9,42	-34,7			2,217			-7,8	-9,42	4,23		6,4	3,650				
618,0	25,75	28,2		1,5	1,80			-2,2	-2,65	-4,45	-4,0			2,213			-3,2	-3,85	-5,65		-8,6	3,641				
Average		29,5						Cumulative biogas volume at 15 day (mL)				1500,12					Cumulative biogas volume at 15 day (mL)				2397,35					
Confidence interval		2,6						Biogas production rate (Lbiogas/KgVS)				140,50						Biogas production rate (Lbiogas/KgVS)				240,22				
CV (%)		3,5																								

Table 30. AB test results.





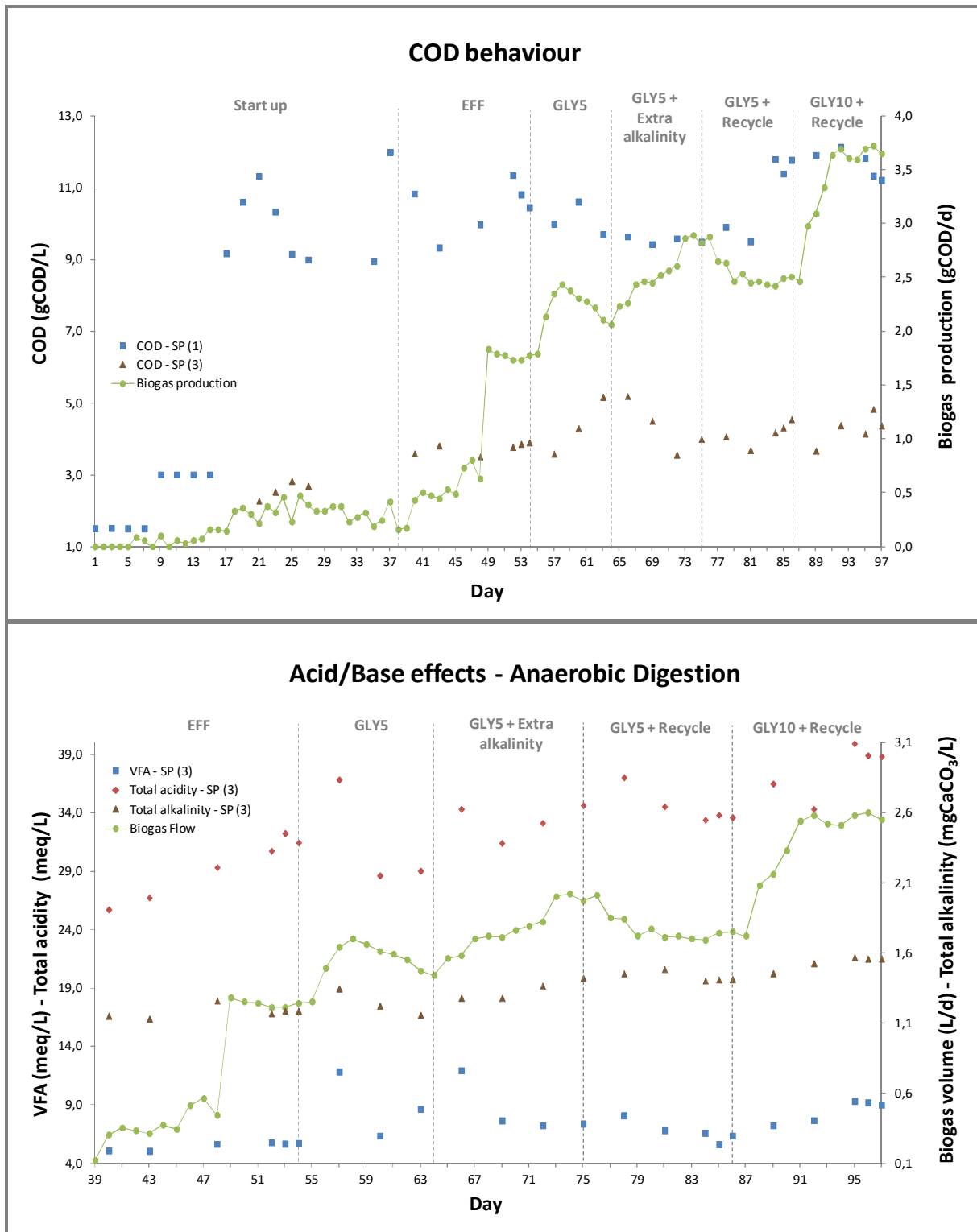
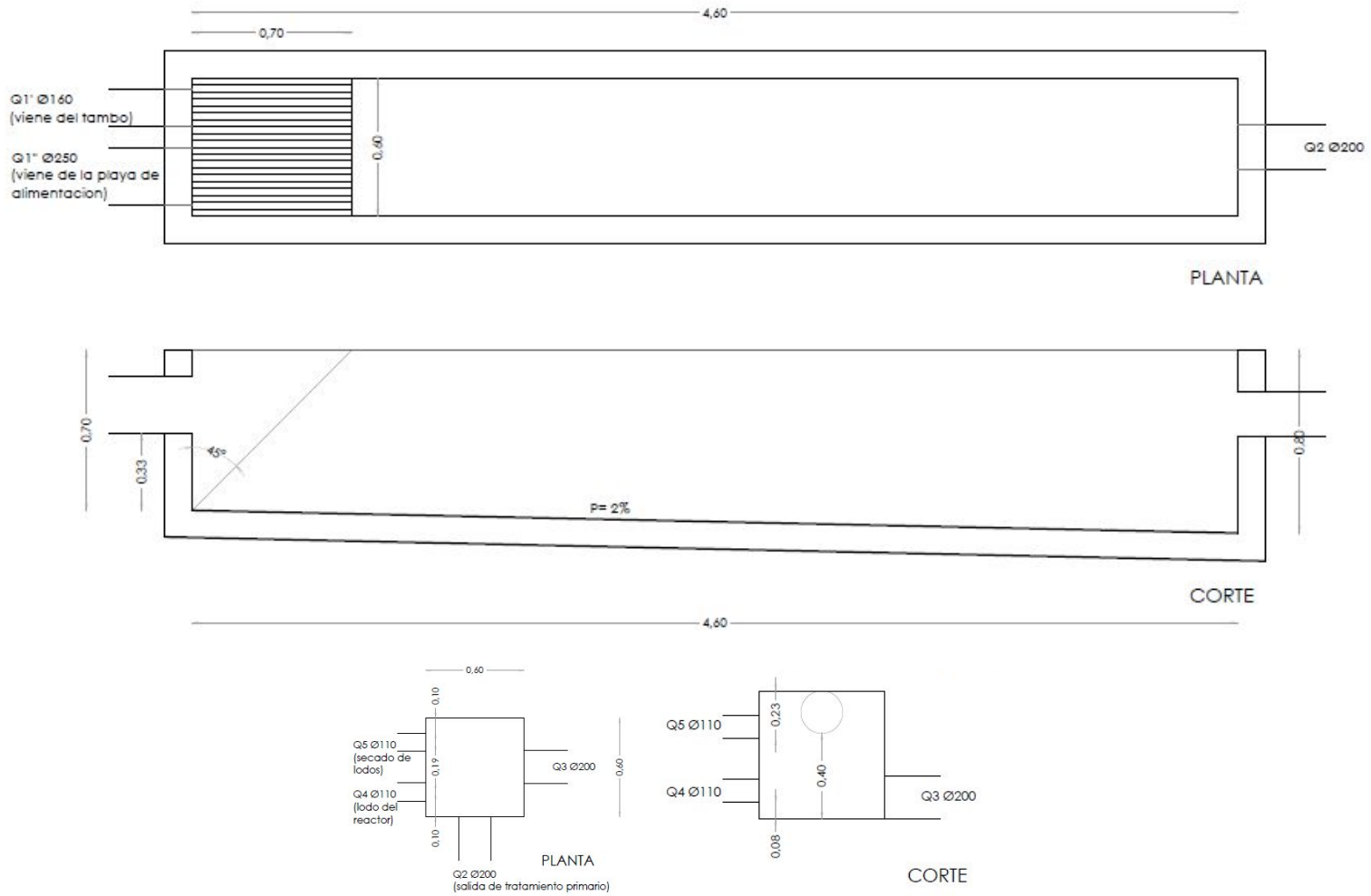

Figure 52. COD behaviour and acid/base effects in the AcD process, complete data.



## Appendix E : Design diagrams



**Figure 53.** Primary treatment design. Left: Coarse screen and grit removal. Right: Distribution box. Flow descriptions:  $Q_1'$  - from milking process.  $Q_1''$  - from feeding process.  $Q_2$  - to distribution box.  $Q_3$  - to reactor.  $Q_4$  - from sludge recycle.  $Q_5$  - from sludge dewatering runoff.

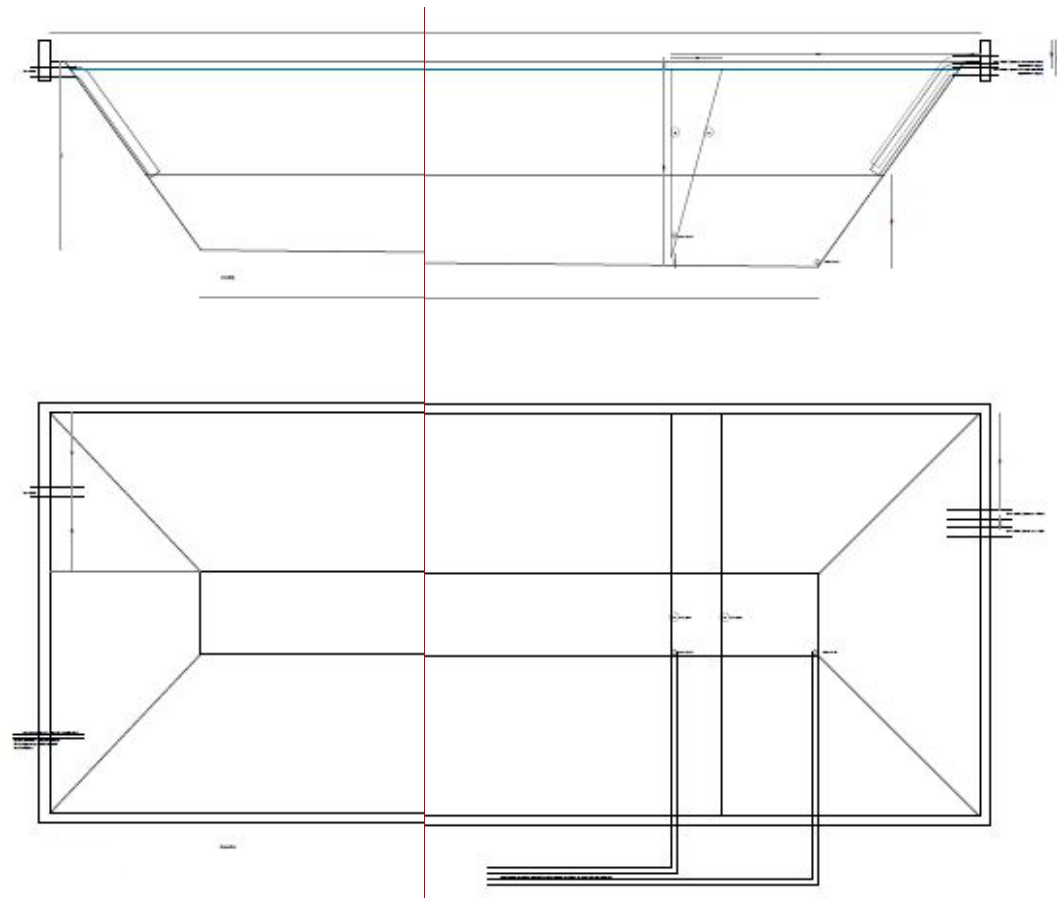
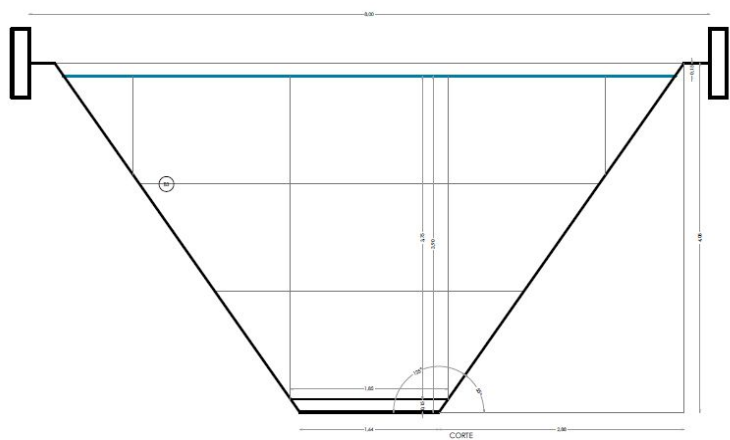

**Figure 54.** Design of the anaerobic reactor. Left: Transversal view of the reactor in the baffles installed. Right: Top view of the reactor, the draw was cut to show the details. Flow descriptions:  $Q_3$  - from distribution box.  $Q_{4A}$  - sludge line.  $Q_{4B}$  - scum recycle to distribution box.  $Q_{6A/6B}$  - to wetlands.

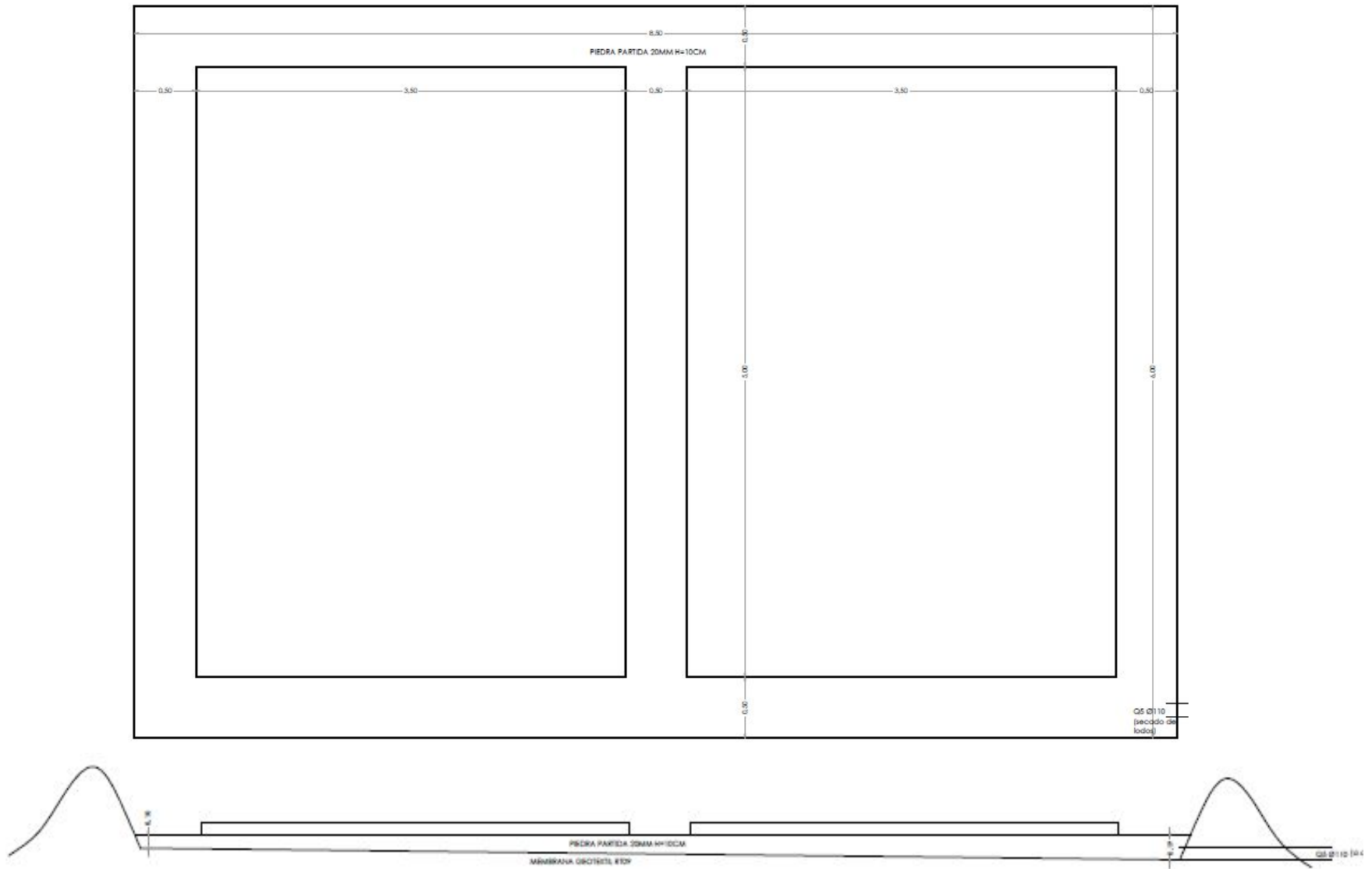

**Figure 55.** Design of the dewatering system. Above: Top view with empty membranes. Below: Transversal view. Flow descriptions:  $Q_5$  - to distribution box.

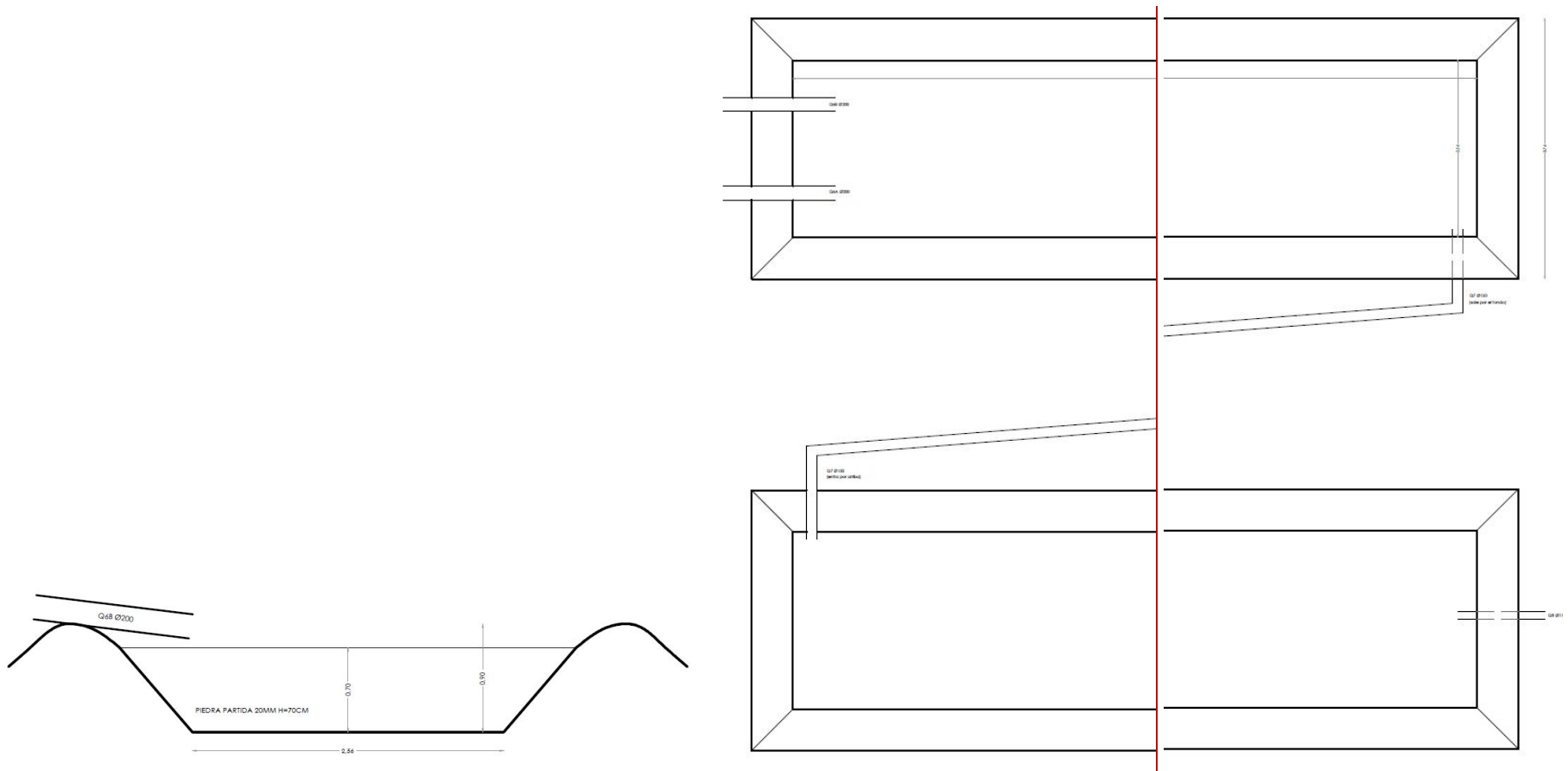

**Figure 56.** Design of the constructed wetlands. Left: Transversal view. Right: Top view. Below: Transversal view, the draw was cut to show the details. Flow descriptions:  $Q_{6A/6B}$  – from reactor.  $Q_7$  - Connection between wetlands.  $Q_8$  - to pond.

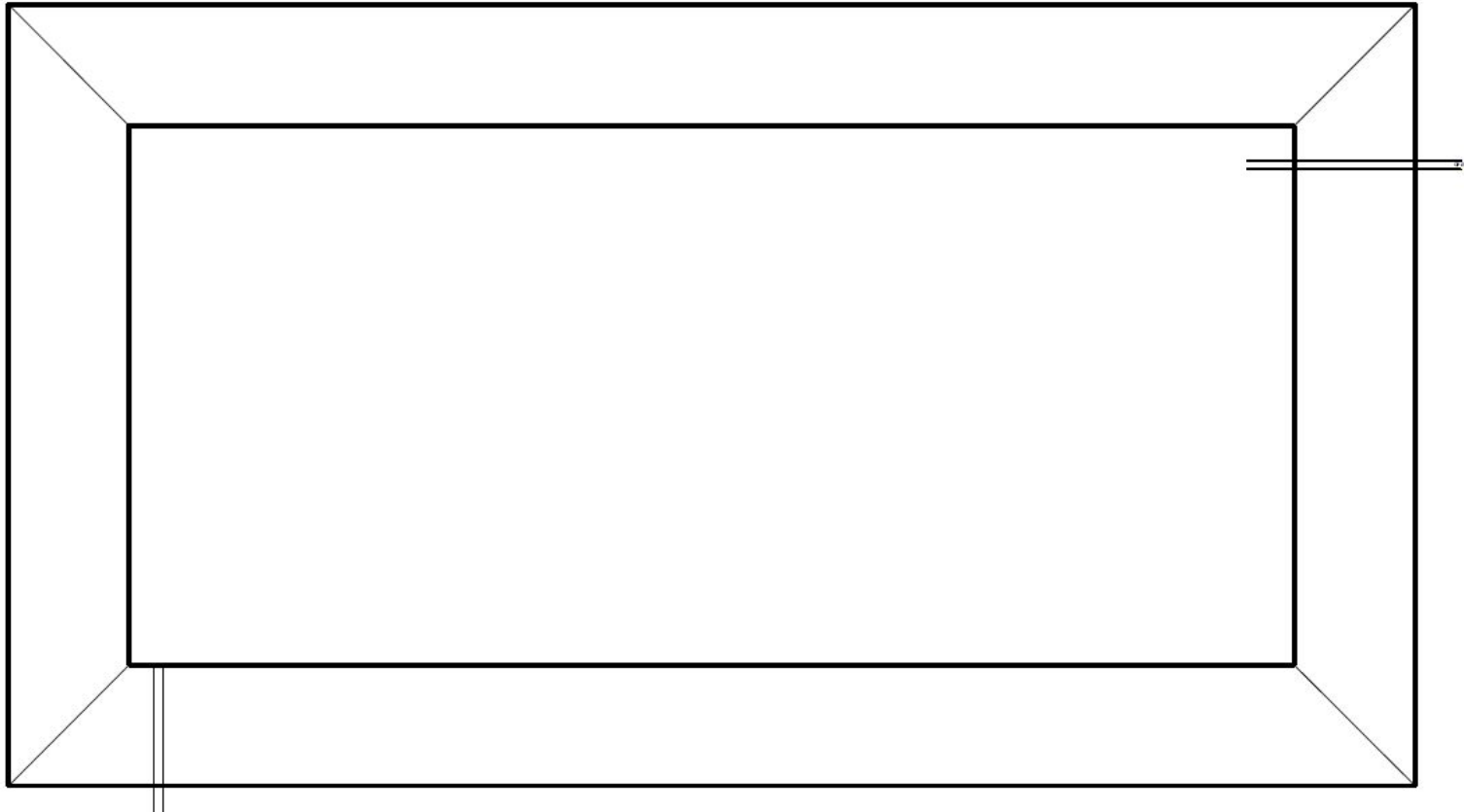

**Figure 57.** Top view of the pond design. Flow descriptions:  $Q_8$  - from wetland.  $Q_9$  - to feeding zone.