

Université de Limoges

École Doctorale Biologie et Santé (ED 524)

UMR 850 INSERM / CHU de Limoges

Thèse pour obtenir le grade de

DOCTEUR DE L'UNIVERSITÉ DE LIMOGES

Discipline / Spécialité : Pharmacologie

Présentée et soutenue par

Ofelia María NOCETI

Le 1^{er}. Juillet 2015

**Étude des relations pharmacodynamiques, pharmacogénétiques
et pharmacocinétiques des immunosuppresseurs
anticalcineurines chez les transplantés hépatiques**

Thèse codirigée par Pr. Pierre MARQUET et Pr. Patricia ESPERON

JURY:

Président du jury

Monsieur le Professeur Robert Barouki, INSERM UPD 1124, Université Paris Descartes.

Rapporteurs

Monsieur le Professeur Nassim Kamar, INSERM U563 IFR-BMT, Université Toulouse -Rangueil.

Monsieur le Professeur Jean-Luc Taupin, CNRS 5164, Université de Bordeaux Ségalen.

Examineurs

Madame la Professeur Graciela Borthagaray, Département de Biochimie Clinique, Faculté de Chimie, Universidad de la República, Uruguay.

Madame la Professeur Patricia Esperon, Département de Biochimie Clinique, Faculté de Chimie, Universidad de la República, Uruguay.

Monsieur le Professeur Pierre Marquet, UMR 850 INSERM/Université de Limoges.



A Dieu par toute l'inspiration et pour avoir rendu possible cette recherche! Pour la force et le courage à la poursuivre!



Remerciements

À Monsieur le Pr. Pierre Marquet, je vous remercie de croire à mon idée, de s'aventurer dans un domaine de recherche innovant mais dans le même temps inconnu, de votre humilité en acceptant le défi ; merci pour votre confiance, pour faire possible ce travail en termes de situation financière, scolaire, scientifique et professionnelle, d'être toujours présent malgré les distances et vos engagements de travail, pour les discussions scientifiques inestimables, pour votre convivialité et l'hospitalité. Enfin tout ce que je peux ajouter, ce serait insuffisant, car vous m'avait permis de réaliser un travail qu'il serait impossible dans mon pays et la région, et ce qui m'a mis sur un niveau à coté des autres chercheurs premiers mondiaux grâce à votre immense générosité.

À Madame le Pr. Patricia Esperón, je vous remercie d'avoir accepté le défi, pour m'a avoir permis à cette cotutelle de thèse, que contrairement elle n'e était pas possible; merci pour votre gestion inestimable à l'hôpital universitaire afin de que je pouvais accéder aux installations nécessaires pour cette recherche en Uruguay, grâce aussi pour transférer des fonds des projets propres, pour le soutien de cette recherche et la rendre possible, merci d'être toujours là et de faire face aux difficultés que ensemble nous devons dû déplacer, et pour tout le soutien au fil des ans, avec l'effort ne seulement que dans la sphère académique et scientifique, mais aussi personnelle.

À Monsieur le Pr. Robert Barouki, je vous remercie de l'intérêt que vous aviez porté à ce travail en acceptant d'être le président du jury. C'est un très grand honneur de vous compter parmi les membres du jury.

À Monsieur le Pr. Nassim Kamar, je suis très honorée que vous ayez accepté d'être rapporteur de mon travail de thèse et je vous remerci aussi de nous avoir transferé part des techniques au laboratoire.

À Monsieur le Pr. Jean-Luc Taupin, merci de m'avoir accueillie à Bordeaux pour m'aider à la mise en place de la technique du NFAT et de pouvoir vous compter parmi les membres du jury.

À Madame le Pr. Graciela Borthagaray, je vous remercie de pouvoir vous compter parmi les membres du jury et même dans ces moments difficiles à surmonter.



À Madame le Pr. Solange Gerona, je vous remercie d'avoir crue à mon projet, pour m'avoir ouvert les portes du Service de Maladies du Foie et de la Transplantation, pour m'avoir mis à disposition les ressources nécessaires à m'aider dans cette enquête, pour les échanges cliniques, pour avoir atteint mon transfert dans le Service et me soutenir dans cet effort et celles à venir.

À Monsieur le Dr. Jean-Baptiste Woillard, je vous remercie pour votre bonne disposition, votre génie et professionnalisme, pour toujours m'aider avec de la patience et transformer mes résultats en pertinents, merci aussi pour votre gentillesse, hospitalité et générosité.

À Monsieur le Pr. Nicolas Picard, je vous remercie pour votre bonne disposition, votre gentillesse et générosité, pour répondre à mes petites questions..., et pour mettre à disposition au cours de ces années les ressources nécessaires, qui ont également contribué à faire de cette recherche possible.

À Monsieur le Dr. Ahmed Boumediene, je vous remercie de m'avoir ouvert les portes du Laboratoire d'Immunologie au CHU, pour votre patience, pour les échanges scientifiques et pour m'avoir donnée accès libre au cytomètre de flux. Merci également pour votre soutien au fil des ans, votre générosité et hospitalité.

À Mademoiselle la Doctorante Lucie Pouché, je vous remercie pour votre bonne disposition, gentillesse et votre contribution à cette recherche.

À Monsieur le Technicien Jean-Hervé Compte, je vous remercie de votre volonté, professionnalisme, précieuse collaboration et gentillesse, pour toutes les fois qui vous m'avait accompagnée à la gare et même jusqu'au l'aéroport et le temps que vous avait pris pour m'amener les réactifs froids afin de que je les pouvais emporter avec moi.

À Madame Karen Poole, je vous remercie pour votre gentillesse, bonne disposition et professionnalisme, pour organiser tous mes séjours à Limoges et déplacements, ainsi que d'autres aspects administratifs de ma cotutelle de thèse ; merci de votre compréhension et hospitalité au fil des ans.



À Madame le Pr. Cristina Touriño, je vous remercie de votre gentillesse, et de m'avoir ouvert les portes du Département de Médecine Fondamentale à l'Hôpital Universitaire et me fournir de l'espace afin de développer mon travail de recherche.

À Madame le Pr. Daniela Lens, je vous remercie de votre générosité et gentillesse ; merci pour les contributions si importantes dans le domaine de la cytométrie en flux, et pour m'avoir permis d'employer votre cymomètre en flux clinique, élément imprescindible dans cette recherche.

À Monsieur le Biochimiste Gonzalo Maldonado, je vous remercie de votre gentillesse, de votre patience et bonne disposition dans ces années pour m'aider avec cette recherche.

À Madame la Clinicienne Danielle Marquet, je vous remercie pour votre hospitalité et convivialité, pour m'avoir reçu chaque année à la maison, en organisant des promenades communes, pour aider à organiser mes déménagements et prendre soin de mes affaires, enfin pour tout votre soutien pendant ces années.

À Monsieur l'Interniste et Hépatologue Marcelo Valverde à Monsieur MSc. Marcelo Vital, à Madame MSc. Lourdes Echarte, à Monsieur le Dr. Martín Rossotti, à Madame la Nurse Coordinatrice de Transplantation Sara González, aux Nurses Betti Beares et Ana Laura Ware, à Madame MSc. Eva González, à Mademoiselle la Médecine Virginia Suaya, à Madame Patricia Festa, à Madame la Dr. Jana Stojanova, à Monsieur le Dr. Sofiane Saada, à Madame la Pr.Chantal Vignoles, à Madame l'Ingénieur Catherine Ouk-Martin, pour votre gentillesse et bonne disposition au fil des ans pour m'aider chacun de son champ d'expertise et pour me permettre cette recherche.



À mon père bien-aimé que n'a pas pu arriver à connaître ce projet, mais que je suis sûre qu'il serait fier de moi.

À ma chère mère et qui n'aimait pas mes voyages pour rester aussi loin de lui, cependant elle les avait surmontées.

Aux mes cousines Ligia, Ivonne et Zuleika, qui pendant mes absences restaient attendues à ma mère.

À ma belle-mère Teresita, qui s'occupait de mon mari pendant presque tous mes stages.

Et en particulier, à mon chéri mari Christian qui m'accompagnée à surmonter mes obstacles, ma colère et mes échecs, mais qui m'avait toujours soutenu avec amour, compréhension et patience.

Et à tous que m'avaient met des obstacles, parce que m'avaient obligée à les battre.



Droits d'auteurs



Cette création est mise À disposition selon le Contrat : « **Paternité-Pas d'Utilisation Commerciale-Pas de modification 3.0 France** » disponible en ligne : <http://creativecommons.org/licenses/by-nc-nd/3.0/fr/>



Résumé

Les inhibiteurs de la calcineurine (ICN) sont les immunosuppresseurs les plus employés en transplantation d'organe et, malgré leur toxicité et leur efficacité imparfaite, ils resteront les premières options thérapeutiques dans un avenir proche. Leurs effets présentent une large variabilité intra- et inter-individuelle, qui n'est pas expliquée par les différences de doses, de concentrations ou d'aires sous la courbe des concentrations en fonction du temps, ce qui limite les bénéfices du suivi thérapeutique pharmacologique et suggère que d'autres facteurs contribuent à la variabilité de la réponse. Comme les ICN ciblent la fonction des lymphocytes T (LT), la concentration des ICN dans les LT a été étudiée comme marqueur intermédiaire de la fonction immunitaire. Effectivement, les concentrations intra-lymphocytaires de TAC chez des transplantés hépatiques montraient une plus forte association avec le rejet aigu que les concentrations dans le sang total, probablement parce qu'elles intègrent la variabilité inter-individuelle d'entrée du médicament dans les LT. De la même manière, des études antérieures ont montré que les concentrations intra-hépatiques de TAC étaient très bien corrélées avec les scores de rejet de Banff, alors que les concentrations résiduelles dans le sang ne l'étaient pas. Les deux pourraient représenter des biomarqueurs pharmacocinétiques intéressants, quoique difficiles à mesurer.

Pour se qualifier comme index d'activité immunosuppressive des ICN, un biomarqueur pharmacodynamique (PD) devrait être directement affecté par l'activité du médicament, c'est-à-dire ne pas être trop éloigné de la cible du médicament et en même temps proche de ses effets cliniques. Comme de nombreuses preuves accréditent le concept que la suppression des LT est le mécanisme clé par lequel les ICN induisent une immunosuppression permettant de prévenir le rejet cellulaire, la fonction et l'activation des LT sont des candidats séduisants pour les stratégies de suivi PD. Toutefois, à ce jour aucun biomarqueur PD ne présente tous les prérequis idéaux, c'est-à-dire est à la fois non-invasif, fiable, sensible, spécifique, reproductible et disponible rapidement. Afin d'identifier des biomarqueurs PD très spécifiques de l'inhibition de la calcineurine et reflétant une part importante de la variabilité inter-individuelle, nos travaux avaient pour objectifs d'explorer la pharmacodynamie des ICN, la force et la variabilité de la



transmission du signal le long de l'axe calcineurine, ainsi que les étapes où les sources de variabilité PD internes (génétiques) ou externes sont les plus influentes.

Dans ce but, nous avons mesuré simultanément la translocation de NFAT1 dans le noyau des cellules mononuclées du sang périphérique (PBMC) (NFAT1 étant l'isoforme prédominante de NFAT dans les LT quiescents ou activés), l'expression intracellulaire d'IL-2 dans les sous-populations lymphocytaires CD3⁺, CD4⁺ et CD8⁺, et l'expression membranaire de CD25 (IL-2R α), un marqueur de surface de l'activation des LT. Un essai clinique non-interventionnel a été mis en place chez des volontaires sains (VS), des patients inscrits en liste d'attente de transplantation hépatique (PLA) et des patients transplantés hépatiques (PTH). Une question différente a été étudiée dans chaque groupe : HS et PLA ont été inclus pour étudier la réponse des LT au tacrolimus (TAC) ex-vivo dans des conditions de stimulation, ainsi que les sources génétiques potentielles de variabilité PD, respectivement dans des conditions physiologiques et pathologiques. Les PTH ont été recrutés pour étudier les relations pharmacodynamiques, pharmacogénétiques et pharmacocinétiques dans des situations d'administration de tacrolimus ou de ciclosporine, c'est-à-dire d'activité PD résiduelle mesurée ex-vivo en conditions de stimulation ou non. Le petit groupe de PTH (n=6) inclus juste avant la transplantation et suivi de façon répétitive pendant la première année post-greffe était prévu pour explorer les relations entre PD des ICN et réponses cliniques.

L'étude chez les VS (n=35) : a exploré la PD du TAC au long de la voie calcineurine en exposant des PBMC ex-vivo au médicament ; a modélisé la transmission du signal au long de cette voie ; a examiné la variabilité inter-individuelle des paramètres pharmacodynamiques du TAC ; et a étudié les sources de cette variabilité et leur contribution à chaque étape de la voie calcineurine. De plus, elle nous a permis d'évaluer la variabilité analytique de nos techniques ainsi que la variabilité intra-individuelle des paramètres PD du TAC. Les PLA (n = 19) nous ont permis de confirmer les résultats obtenus chez les VS, ainsi que de tester l'influence potentielle de leur maladie initiale sur la pharmacodynamie ex-vivo du TAC. Les buts de l'étude transversale chez des PTH (n=80) étaient d'explorer la variabilité inter-individuelle de la PD des ICN dans des situations cliniques réalistes et les sources pharmacogénétiques potentielles de cette variabilité.



Nous avons mesuré par cytométrie en flux la présence de NFAT1 transloqué dans le noyau des PBMC (qui est très proche de l'activité phosphatase de la calcineurine et probablement plus spécifique que la mesure « directe » de son activité, qui nécessite d'inhiber d'autres activités phosphatases), ainsi que la fonction (IL-2) et l'activation (CD25) des LT comme marqueurs du statut de l'immunité cellulaire. Les PBMC ont été séparés par gradient de centrifugation à partir d'échantillons de sang total recueillis avant l'administration du médicament et à jeun. Des aliquots frais de 10^6 PBMC dans 100 μ l de RPMI supplémenté ont été employés pour toutes les analyses. Les PBMC des VS et des PLA ont été exposés ex-vivo pendant 30 min à des concentrations de TAC entre 0 et 50 ng/mL avant chaque mesure. Les mesures de NFAT1 étaient précédées d'une stimulation polyclonale par du phorbol 12-myristate 13-acétate (PMA) à 50 ng/mL et du calcium ionophore (I) à 2.5 μ g/ml, à 37°C dans une atmosphère humidifiée avec 5% CO₂ pendant 30 min, pour garantir la translocation de NFAT1 vers le noyau. Après deux lavages avec du PBS 1X froid, les cellules étaient incubées dans la glace pendant 30 min avec du tampon de lyse PIPE (pH 7,4 dans le PBS 1X) pour perméabiliser les noyaux cellulaires. Après deux nouveaux lavages avec de la BSA à 1% dans le PBS 1X, 50 μ L d'un mélange d'anticorps anti-NFAT1 à 5 μ g/ml dans le PBS 1X étaient ajoutés au milieu pour 30 min d'incubation dans la glace. Puis des Ig polyclonales à 0,33% marquées au PE (fragment F(ab')₂ de chèvres anti- IgG(H+L) de souris) étaient ajoutées. Après 15 min d'incubation dans la glace à l'abri de la lumière, le signal fluorescent résultant des noyaux de PBMC marqués a été mesuré par cytométrie de flux et l'intensité de fluorescence moyenne de NFAT1 dans les noyaux isolés utilisée pour les analyses statistiques.

La mesure d'IL-2 intra-cellulaire a nécessité 5h d'activation polyclonale avec du PMA/I et de la bréfeldine à 1 μ g/ml (pour arrêter la sécrétion de protéines) à 37% en atmosphère humidifiée avec 5% de CO₂. Les cellules étaient alors : i) marquées avec des marqueurs de surface anti-LT humain (CD3 PerCP-Cy5.5, CD4 FITC, CD8 PE-Cy7); ii) fixées : iii) perméabilisées (IntraPrep) ; iv) marquées avec des anticorps PE de rat anti-IL-2 humains et avec des IgG2a κ PE de rat comme contrôle isotypique.

Pour la mesure d'expression de CD25, des aliquots de PBMC ont été incubés pendant 72h à 37°C et 5% de CO₂ en présence de 7,5 μ g/ml de Concanavaline A dans du RPMI 1640 1X.



Après deux lavages additionnels dans le PBS 1X, un marquage direct était réalisé avec : CD3 PerCP–Cy5.5, CD4 PE, CD8 PE-Cy7 et CD25 APC. L'analyse par cytométrie de flux était pratiquée après 30 min d'incubation dans le noir et deux lavages avec de la BSA dans du PBS 1X.

De plus, pour les PLA et PTH, un aliquot de PBMC a été analysé sans stimulation ex-vivo (NS condition) pour NFAT1, IL-2 et CD25.

L'expression d'IL-2 et CD25 a été exprimée en pourcentage de cellules fluorescentes sur le nombre total de cellules CD4⁺, CD8⁺ ou CD3⁺, respectivement. Les cytomètres de flux employés pendant ce travail étaient un LSRFortessa et un Cantoll (Beckton-Dickinson), chacun équipé de 3 lasers. Les lymphocytes ont été choisis comme population de contrôle interne biologique de façon à ajuster les réglages de dispersion de la lumière du cytomètre. Comme la stabilité d'expression antigénique des lymphocytes CD4⁺ entre individus a été bien établie, nous avons décidé d'utiliser 50 000 événements CD4⁺ comme critère d'arrêt pour les mesures d'IL-2 et CD25. La spécificité de nos marqueurs était garantie par la conception de nos expériences, les sous-populations lymphocytaires ciblées, les anticorps et fluorochromes choisis, ainsi que par nos stratégies de fenêtrage (« gating ») en cytométrie en flux. La sensibilité de notre technique a été évaluée par le principe de la fluorescence de contrôles moins un (c'est-à-dire avec tous les anticorps dans le tube sauf celui d'intérêt pour chaque paramètre étudié), donnant des rapports limite de détection / limite du blanc de 0,2% pour IL-2⁺CD4⁺, 0,2% pour IL-2⁺CD8⁺ et 0,2% pour NFAT1 (étude chez les VS). La technique a été validée par l'analyse de 5 répliquas chez chacun de 5 VS, chaque jour pendant 3 jours consécutifs. Pour la plupart des biomarqueurs, la réplication des analyses les second et troisième jours n'a pas été possible, du fait de la disparition de leur expression. Toutefois, nous avons pu montrer une excellente reproductibilité analytique intra-jour.

Plus de 20 000 images ont été analysées selon la même stratégie pour tous les biomarqueurs, de façon à minimiser la variabilité du fenêtrage. Le logiciel FLOWJO nous a permis de regrouper et d'étudier simultanément un grand nombre d'images dans un environnement versatile et très opérant.



*Pour examiner la contribution des pharmacogènes à la variabilité PD des ICN, nous avons ciblé les polymorphismes situés : 1) dans les régions promotrices des gènes codant les sous-unités de la calcineurine (PPP3R1; PPP3R2; PPP3CA; PPP3CB) et les immunophilines [cyclophiline A (PPIA) et FKBP12], car ils pourraient affecter leur transcription ; 2) dans les exons et introns d'autres gènes codant les protéines directement associées à la transmission du signal dans la voie calcium/calcineurine/NFAT. Nous avons utilisé le séquençage Sanger pour les premiers et la RT-PCR pour les seconds. Les gènes NFAT1, NFAT2 et PPP3CA ont été cartographiés à la recherche des motifs impliqués dans les interactions protéiques nécessaires à la déphosphorylation de NFAT et à sa translocation dans le noyau. Concernant les gènes du métabolisme des ICN, les membres de la famille d'enzymes CYP3A sont les plus abondants CYP450 dans le foie et l'intestin humains. En particulier, un variant dans l'intron 3 de CYP3A5 (A6986>G rs776746) a été systématiquement rapporté comme étant lié au besoin de dose et à la concentration résiduelle du tacrolimus. De plus, les variants du CYP3A4 semblent participer à la variabilité PK du TAC, en particulier un SNP dans l'intron 6 (rs35599367 C>T; CYP3A4*22TT) qui a été associé à une expression réduite de l'ARNm du CYP3A4 dans le foie et à un besoin de dose plus faible du TAC que chez les porteurs homozygotes « sauvages » (CC, ou *1*1). Dans notre étude, nous avons examiné l'influence sur l'exposition aux ICN des génotypes CYP3A5*3 du donneur et du receveur, du génotype CYP3A4*22 du donneur et de trois génotypes (et de l'haplotype correspond) d'ABCB1 du receveur.*

Pour toutes les variables et groupes étudiés, la normalité de la distribution a été vérifiée à l'aide du test de Sapiro-Wilk et, si besoin, les données ont été log-transformées. Les résultats de cytométrie de flux ont été analysés en fonction du logarithme de la concentration de TAC à l'aide de modèles d'inhibition sigmoïdes (GraphPad PRISM®), pour en déduire l'activité basale (I_0), la concentration inhibitrice 50% (IC_{50}) et l'inhibition maximale (I_{max}). L'expression d'IL-2 dans les LT CD4⁺ et CD8⁺ et celle de CD25 dans les cellules CD3⁺ ont été étudiées en fonction de l'expression de NFAT1, en testant un grand nombre de modèles classiquement employés pour l'inhibition enzymatique ou pour la réponse des récepteurs, ainsi que des modèles plus simples de régression linéaire ou non-linéaire. Dans tous les cas, nous avons évalué leur adéquation ('goodness of fit') à l'aide de tests non-paramétriques.



L'influence de polymorphismes génétiques a été testée à l'aide du logiciel R version 2.15.1. La conformité des résultats de génotypage avec l'équilibre d'Hardy-Weinberg a été vérifiée à l'aide du test exact de Fisher avec le package R « SNPAssoc ». Les déséquilibres de liaison entre polymorphismes ont été recherchés pour PPP3R1 rs72174030, rs4347819 et rs4519508 et pour IL2RA rs10795791, rs11594656 et rs35285258 et les haplotypes les plus probables ont été estimés à l'aide du package « haplo.stat ». Les relations entre polymorphismes mono-nucléotidiques (SNP) ou haplotypes et paramètres PD du TAC (I_0 , IC_{50} , et I_{max}) pour les différents biomarqueurs ont été explorées par régression multilinéaire. Nous avons comparé des modèles génétiques récessifs, dominants et log-additifs sur la base du critère d'information d'Akaike. Les SNP ou haplotypes significatifs ($p < 0,05$) en analyse univariée ont été inclus dans un modèle multivarié intermédiaire et retenus dans le modèle multivarié final seulement s'ils avaient survécu à la stratégie de sélection rétrograde, sur la base du critère d'Akaike. La correction de Bonferroni a été appliquée aux modèles finaux pour prendre en compte les tests multiples. Nous avons estimé le pourcentage de variabilité expliquée par les SNP ou haplotypes dans ces modèles finaux par leur coefficient R^2 calculé par ANOVA comme le rapport entre la variabilité associée à la variable et la variabilité totale.

Pour le groupe transversal de PTH, nous avons conçu un modèle basé sur les étapes de la voie calcineurine et nous l'avons attaqué avec les covariables que nous avons jugé les plus pertinentes à chaque étape. Les relations entre SNP et haplotypes et les différents biomarqueurs PD ont également été étudiées par régression multilinéaire, avec des critères similaires à ceux décrits pour les VS et les PLA. La correction de Bonferroni a été appliquée aux valeurs p des modèles finaux pour tenir compte des 5 tests effectués pour les conditions physiopharmacologiques (sans stimulation) et les 6 tests après stimulation mitogénique des PBMC. Le pourcentage de variabilité expliquée par les SNP ou haplotypes dans ces modèles finaux a également été estimé par ANOVA.

Les différentes populations incluses dans l'étude clinique 3PIGREF ont été analysées en intention de traiter.



Résultats

Un nombre total de 35 VS et 87 patients (dont 19 PLA) ont été inclus. Parmi les 14 PLA inclus qui ont effectivement été transplantés, seuls 6 ont pu bénéficier d'un suivi pendant plus de deux visites. Toutefois, deux d'entre eux ont été rapidement convertis à l'évérolimus et ont dû être exclus de l'étude. Six autres patients ont été inclus immédiatement après la transplantation (et non avant) et ont été suivis, mais deux d'entre eux ont également été convertis rapidement à l'évérolimus et ont quitté l'étude. Comme la gestion de cette cohorte prospective a été difficile, du fait de complications post-transplantation imprévisibles et du faible nombre de sujets restant pour l'analyse statistique, les résultats préliminaires de cette partie de la recherche ne sont pas présentés dans ce mémoire, et cette partie de l'étude sera poursuivie pour inclure un plus grand nombre de patients et permettre ainsi une évaluation statistique correcte.

Ce travail est à l'origine de plusieurs nouvelles découvertes. Après l'exploration complète de la voie calcineurine par une approche PK/Pgx/PD simultanée chez l'homme ou sur des cellules humaines ex-vivo, il a montré que la pharmacodynamie du TAC était cohérente, de l'expression de NFAT1 dans les noyaux de PBMC jusqu'à celle de CD25 dans plusieurs sous-populations de LT, suivant un modèle I/I_{max} à chaque étape, et que les réponses IL-2 et CD25 dépendaient de l'inhibition de la translocation nucléaire de NFAT1 dans les PBMC selon un modèle sigmoïde allostérique. La reproductibilité analytique intra-jour présentait des coefficients de variations $< 9\%$ pour les niveaux physiologiques (I_0). La variabilité intra-individuelle estimée chez trois VS était entre 3.2 et 6.5% pour I_0 et entre 8,6 et 17% pour IC_{50} (sauf pour NFAT1, IC_{50} CV = 50%). Les niveaux I_0 des différents biomarqueurs ont montré une variabilité modérée, alors que celle des IC_{50} et I_{max} était beaucoup plus élevée. Après transformation logarithmique de tous les paramètres (car la plupart n'était pas normalement distribués), la variabilité inter-individuelle était légère à modérée pour les valeurs d' I_0 (CV = 11% à 20%) et pour les valeurs d' I_{max} de NFAT1 et CD25 (CV = 14%), mais beaucoup plus grande pour l' I_{max} d'IL-2 dans les cellules $CD4^+$ et $CD8^+$ (CV = 71% et 195%, respectivement), deux mesures très proches de la limite de détection de la technique (0,2%).



Ainsi, nous avons mis au point une technique répétable pour cette étude, comme indiqué par sa variabilité globale faible à légère, qui est moindre que la variabilité intra- et inter-individuelle et en accord avec ce que d'autres groupes ont décrit (même si les comparaisons sont difficiles du fait de marqueurs, types cellulaires et schémas expérimentaux différents). L'étude d'association pharmacogénétique chez les VS suggère que l'haplotype des alleles sauvages de trois SNP du gène codant pour CD25 diminuent (en conditions de stimulation) l'expression d'IL-2 dans les cellules CD4⁺ et la configuration muté du même haplotype diminuent celle de CD25 dans les LT. Un variant dans la région promotrice de la cyclophiline diminue l'IC₅₀ du TAC pour la translocation nucléaire de NFAT1, alors que l'I_{max} correspondante à l'expression d'IL-2 dans les CD4⁺ semble être augmentée par le polymorphisme (GCC)_{10/10} des triplets de nucléotides dans le promoteur de la sous-unité catalytique de la calcineurine.

Chez les PLA, après transformation logarithmique de tous les paramètres nous avons constaté une variabilité inter-individuelle légère à modérée (CV = 17 à 28%) de l'I₀ (en conditions stimulées) de NFAT1 et d'IL-2 dans les LT CD4⁺, alors que variabilité de l'IC₅₀ du TAC était beaucoup plus forte pour tous les biomarqueurs, ainsi que pour les biomarqueurs non stimulés (sauf pour NFAT1, CV = 12%). De façon intéressante, la variabilité inter-individuelle de l'I_{max} était faible dans le cas de NFAT1 (CV = 8.9%), modéré pour CD25 (CV = 20, 33 et 33% pour les cellules CD3⁺, CD4⁺ et CD8⁺, respectivement) et était la plus forte pour IL-2 (CV = 206% et 58% pour les LT CD4⁺ et CD8⁺, respectivement). Au niveau d'inhibition maximale de TAC, NFAT1 dans les noyaux de PBMC, IL-2 dans les CD8⁺ et CD25 dans les LT n'étaient pas complètement inhibés. L'IC₅₀ du TAC augmentait en descendant la voie calcineurine, avec des moyennes géométriques de 0,6 ng/ml pour le NFAT1 jusqu'à 1,3 ng/ml pour CD25^{High} CD4 et CD8dim. Les valeurs individuelles d'IC₅₀ variaient d'un facteur 10 pour NFAT1, 200 pour CD25 dans les LT CD4⁺, 300 pour IL-2 et CD25 dans les CD8⁺, 600 pour IL-2 dans les CD4⁺ et 1000 pour CD25 dans les lymphocytes T. Comme chez les VS, une relation sigmoïde allostérique reliant l'expression d'IL-2 et de CD25 à celle de NFAT1 dans les noyaux de PBMC a été trouvée chez les patients en liste d'attente de greffe hépatique. Le SNP PPP3CA C149278688A expliquait 77% de la variabilité des niveaux NS de l'I₀ de NFAT1 (p = 0,0019); PPIA G6850A expliquait 78% de la variabilité de l'I₀ de CD25^{High}CD3dim NS; tandis que pour les niveaux Stim PPIA G8177826C explique 83% de celle de l'I₀ de



CD25^{High}CD4dim; IL2RA T35285258C 94% de la variabilité de l'IC₅₀ de CD25^{High}CD8dim; et IL2RA T11594656A 96% de la variabilité de l'I_{max} de CD25^{High}CD4dim.

L'étude des PTH sous TAC a montré que, sans stimulation ex-vivo, les niveaux de NFAT1 dans les noyaux de PBMC (valeurs individuelles dans un rapport de 10), l'expression intracellulaire d'IL-2 dans les LT CD4⁺ et de CD25 dans les CD8⁺ (rapport de 20) présentaient une variabilité inter-individuelle faible à modérée, tandis que la variabilité de l'expression d'IL-2 dans les LT CD8⁺ (rapport 100) et de CD25 dans les CD4⁺ (rapport 300) et les CD3+ (rapport 500) était très grande.

Par comparaison, après stimulation ex-vivo la variabilité inter-individuelle des biomarqueurs était plus petite, sauf pour CD25 et IL-2 dans les LT CD8⁺ (rapport 100 pour chaque). Les niveaux stimulés d'IL-2 et CD25^{High} dans les CD8⁺ montraient la plus grande variabilité, des valeurs plus faibles étaient trouvées pour CD25^{High} dans les LT CD3⁺ et CD4⁺ et NFAT1 dans les noyaux de PBMC montraient la plus faible variabilité (comme en conditions non stimulées). De plus, aucun des biomarqueurs PD n'était complètement inhibé, à l'exception d'IL2⁺CD4⁺ en conditions de stimulation. Aucun des biomarqueurs en aval de NFAT1 ni aucune des covariables n'avait apparemment d'influence sur la PD du TAC chez les PTH.

Chez les PTH sous CsA, les niveaux d'expression stimulés ou non de NFAT1 dans les PBMC montraient une variabilité légère à modérée (CV = 15%, correspondant à un facteur 9 de variabilité), alors que des valeurs plus fortes étaient observées pour IL-2 dans les LT CD4 stimulées ou non, et pour CD25 dans les cellules CD3 et CD4 stimulées et dans les CD8 non-stimulées (CV entre 49 et 82%). Des valeurs de CV beaucoup plus élevées ont été obtenues pour IL-2 dans les CD8 stimulées (CV = 127%) et surtout pour CD25 dans les CD8 stimulées (CV = 355%) et dans les CD3 et CD4 non stimulées (CV entre 644 et 10089%). Par conséquent, la variabilité inter-individuelle des marqueurs stimulés était inférieure ou égale à celle des niveaux « physiopharmacologiques », sauf pour IL-2⁺CD4⁺ and CD25^{High}CD8dim. Les analyses multivariées ont révélé que l'âge des receveurs était associé positivement aux niveaux de NFAT1 dans les noyaux de PBMC non-stimulés et que l'étiologie HVC se montrait associée à une expression augmentée de CD25^{High} dans les LT CD8⁺ stimulées. En plus dans des conditions non-stimulées l'allele sauvage de l'ABCB1 T1128503C augmente l'expression d'IL-2 dans les cellules T CD8⁺.



Tandis que l'allele muté dans la region promotrice de la cyclophiline A G8177826A diminue l'expression de l'IL-2 dans les cellules LT CD4⁺ et CD8⁺ T et dans le CD25^{High} dans les CD3⁺ T stimulées. Pourtant, l'influence de l'allele muté de la region promotrice de la subunité regulatrice de la calcineurine T4519508C augmente l'expression de le CD25^{High} dans les LT stimulés CD4⁺. En plus de l'influence de l'HVC pré-transplantation, les polymorphismes d'ABCB1, PPIA et PPP3R1 se sont révéle des déterminants de la PD de la CsA après correction de Bonferroni. Le SNP ABCB1 1128503T expliquait 74% de la variabilité d'IL-2⁺CD8⁺ non stimulée, PPP3R1 4519508T 80% de la variabilité de CD25^{High} dans les LT CD4⁺ stimulés et la maladie HVC 76% de la variabilité de CD25^{High} dans les LT CD8⁺ stimulés. De plus, PPIA 8177826G comptait pour 87% de la variabilité d'IL-2⁺CD4⁺, pour 77% de celle d'IL-2⁺CD8⁺ et pour 83% de la variabilité de CD25^{High}CD3dim en conditions de stimulation. Aucune influence significative des caractéristiques génétiques du donneur sur la PK de la CsA n'a été trouvée.

Comme indiqué plus haut, certains des biomarqueurs PD du TAC et de la CsA ont pu être mesurés sans stimulation ex-vivo (NS), ce qui reflète peut-être plus fidèlement leur activité pharmacologique réelle qu'après stimulation par des mitogènes (stim). Ces biomarqueurs n'étaient pas influencés par les doses ou les concentrations résiduelles de TAC ou de CsA et montraient une grande variabilité inter-individuelle, à la fois en conditions NS et stim.

Discussion

Après activation de la calcineurine, les protéines NFAT sont déphosphorylées et libérées de leur mécanisme de répression, permettant ainsi leur translocation dans le noyau où, en présence de leur partenaire protéique collaboratif AP1, elles déclenchent la transcription de gènes cibles, dont IL2 et IL2R α . Notre hypothèse était que l'inhibition de la translocation de NFAT1 dans le noyau par les ICN serait un biomarqueur informatif de la signalisation CaN/NFAT, en particulier plus spécifique de l'activité immunosuppressive des ICN que l'inhibition de l'activité calcineurine elle-même, dont la mesure nécessite d'inhiber plusieurs autres phosphatases. L'IL-2 agit comme principal facteur de croissance des LT, régulant l'amplitude et la durée de la réponse immunitaire T après un stimulus antigénique. L'expression intra-cellulaire IL-2 par différentes sous-populations de LT a déjà été évaluée comme marqueur de réponse pharmacologique du tacrolimus,



avec l'hypothèse que si cette cytokine est réprimée l'activation lymphocytaire devrait l'être également. La calcineurine contrôle également l'expression de certains récepteurs de surface des lymphocytes T, à travers la transcription de gènes sous dépendance de NFAT. En particulier, l'expression de CD25, la chaîne alpha inductible et de haute affinité du récepteur à l'IL-2, reste basse dans les cellules T au repos et est augmentée précocement par l'activation du TCR. De plus, elle forme avec l'IL-2 une boucle d'auto-régulation positive pour assurer l'activation des LT. IL2 et CD25 peuvent donc être combinées comme marqueurs de la réponse des LT.

Durant un état inflammatoire, la réponse immune du receveur est dirigée par la balance entre deux forces opposées, la réaction pro-inflammatoire (Th1, impliquant les cytokines IL-2 et IFN γ), qui recrute des cellules inflammatoires vers les sites lésés, et la réponse anti-inflammatoire (conduite par TNF α , IL-1 β and IL-6), dont le rôle est de limiter les lésions tissulaires et de promouvoir la réparation. Les monocytes et les lymphocytes participent aux deux types de réaction. La résultante de ces deux voies de signalisation détermine l'étendue de la réaction inflammatoire de l'hôte et les effets cliniques. Bien que la plupart des cytokines pro-inflammatoires ou d'immunorégulation soient augmentées pendant les rejets aigus cellulaires (RAC) du greffon, elles ne permettent pas de faire la distinction entre RAC et infections, ce qui limite leur utilité clinique. En transplantation d'organe, l'un des objectifs des ICN est de réduire la production d'IL-2 (fonctionnalité des LT), de façon à minimiser l'inflammation et le rejet du greffon. Au contraire, dans la mesure où une association significative entre l'expression d'IL-2 dans les lymphocytes infiltrant le greffon et le rejet aigu du greffon a été rapportée dans la littérature, l'expression intra-cellulaire d'IL-2 pourrait mieux refléter les effets des ICN chez les patients transplantés.

Dans notre travail, l'expression d'IL-2 dans les cellules Th1 de PTH sous TAC était assez élevée, atteignant les mêmes valeurs que chez les VS non exposés au médicament. Ceci pointe vers l'existence d'un état activé/inflammatoire chez ces patients, probablement lié au conflit immunologique entre le greffon et le système immunitaire du receveur, malgré l'action des immunosuppresseurs. De plus, des études antérieures par Canivet et coll. ont montré que l'expression de CD25 dans les LT était diminuée chez les patients avec une maladie hépatique en liste d'attente de TH, ce que notre étude a confirmé.



Ceci pourrait expliquer en partie les plus faibles besoins d'immunosuppression chez les PTH par rapport aux receveurs d'autres organes transplantés. Par ailleurs, dans notre étude les PTH avec des niveaux de $CD25^{High}CD4^{dim} < 1,2\%$ sans stimulation, ou $< 3\%$ avec, ont développé par la suite au moins un épisode de RAC. Nous avons trouvé une association significative entre l'existence d'un hépatocarcinome pré-transplantation et les niveaux de $CD25^{High}CD8^{dim}$ sans stimulation, ce qui est cohérent avec le fait que les cellules cytotoxiques $CD8^+$ contribuent au développement de l'HCC.

Des études antérieures ont discuté de l'influence de l'âge du donneur et du receveur sur la survie du greffon, du fait des modifications fonctionnelles des leucocytes qui pourraient être partiellement responsables de l'immunodéficience cellulaire et humorale du sujet âgé. Böhlet et coll. ont postulé que l'âge exerçait une influence sur les fonctions spécifiques des LT et que l'augmentation de l'expression des cytokines pro-inflammatoires avec l'âge pourrait affecter la survie des greffons. De plus, ils ont suggéré que la corrélation positive entre les cellules T activées $CD25^{High}$ et l'âge qu'ils avaient trouvé chez les patients transplantés pourrait induire la prolifération des lymphocytes T en réponse à l'IL-2. Nous avons également trouvé une corrélation positive entre l'âge des receveurs et l'expression de CD25 dans les cellules $CD3^+$ et $CD4^+$ non stimulées chez les PTH sous TAC. D'autre part, comme Bohler et coll et Lemaire et coll, nous n'avons trouvé aucune relation significative entre les concentrations résiduelles de tacrolimus et les biomarqueurs de fonction ou d'activation des lymphocytes T.

Différents variants dans la région promotrice des gènes de la cyclophiline A et des sous-unités catalytique et régulatrice de la calcineurine sont capables d'influencer l'activation ou la fonction des lymphocytes T (mesurées avec ou sans stimulation). Les patients transplantés portant l'allèle sauvage d'ABCB1 (codant pour la protéine d'efflux P-gp) avaient une fonction et une activation cellulaire T accrue. Des travaux précédents ont mis en évidence l'influence importante de l'expression de CYP3A5 à la fois dans le foie greffé et dans l'intestin du receveur. En effet, les receveurs porteurs du seul génotype CYP3A5*1 intestinal nécessitaient déjà de plus fortes doses de TAC et présentaient des rapports concentration/dose plus faibles que les non-expresses. En transplantation hépatique, les activités enzymatiques CYP3A5 intestinale du receveur et hépatique du donneur peuvent prendre en charge le métabolisme du médicament de façon



synergique, d'où l'importance de caractériser les deux, si possible avant ou pendant la transplantation de façon à optimiser la dose initiale d'ICN.

D'autres sources de variabilité de la réponse des LT au ICN, en lien avec le TCR, CaM, calcineurine, l'expression des différentes isoformes de NFAT, IL-2, ainsi que les niveaux physiologiques de lymphocytes T et Treg ont été identifiées. Les différences de réponse aux ICN sont probablement dues à la grande variabilité inter-individuelle à tous les niveaux de ce réseau complexe.

La position de l'activité CaN, ainsi probablement que celle du NFAT, est trop haute dans ce réseau pour intégrer ces sources de variabilité, au contraire d'IL-2 et de CD25. De plus, comme ces deux dernières sont responsables de la fonction et de l'activation des cellules T, respectivement, elles sont plus proches de la réponse immune et leur mesure pourrait permettre de mieux prédire les effets cliniques.

Au total, notre étude ex-vivo de PBMC de volontaires sains a principalement montré : que l'inhibition de NFAT1 dans les noyaux de PBMC et celle de l'expression d'IL-2 et CD25 dans différentes sous-populations de LT suivaient un modèle I/I_{max} ; que les réponses IL-2 et CD25 à l'inhibition de NFAT1 suivaient un modèle sigmoïde allostérique ; et que plusieurs polymorphismes dans les gènes impliqués dans la pharmacodynamie des ICN participaient à la variabilité inter-individuelle de ces biomarqueurs. Chez les patients en liste d'attente de transplantation hépatique nous avons pu : mesurer les paramètres PD des ICN avec ou sans stimulation ex-vivo, reflétant ainsi probablement l'activité résiduelle et la réserve immunologique des biomarqueurs PD après exposition à des concentrations croissantes de TAC, respectivement ; mettre en évidence des relations PG/PD ainsi que des interactions PD/PD au sein de la voie calcineurine. Les PTH sous CsA présentaient une plus grande variabilité inter-individuelle que ceux sous TAC et des régulations apparemment différentes au sein de la voie calcineurine.

En résumé, IL-2 et CD25 dans les LT CD8⁺ et CD25 dans les LT CD4⁺ pourraient être des biomarqueurs fiables de l'activité des ICN, présentant les plus hauts niveaux de variabilité inter-individuelle. De plus, quelques cas cliniques suggèrent que la concentration de NFAT1 dans les noyaux de PBMC pourrait permettre de prédire les épisodes d'infection, tandis que la diminution des Treg et une forte expression d'IL-2 dans les LT CD8⁺ pourraient précéder les rejets aigus cellulaires.



Summary

Calcineurin inhibitors (CNI) are the immunosuppressants most employed in solid organ transplantation and despite their toxicity and suboptimal efficacy they will remain the first therapeutic option for time ahead. Their effects show huge intra- and inter-individual variability, not explained by differences in drug doses, concentrations or areas under the concentration-time curve, limiting the benefits of therapeutic drug monitoring and suggesting that other factors contribute to response variability. As CNI target T cell function, CNI concentration in lymphocytes was studied as a surrogate marker of the immune function. Actually, intra-lymphocyte TAC levels in liver transplant patients were better associated with acute rejection than whole blood levels, probably because they integrate potential inter-individual variations of drug entry into the lymphocytes. In the same line, previous studies showed that intrahepatic TAC levels displayed excellent correlation with the Banff rejection scores, whereas trough blood levels did not. Both may represent interesting, although difficult to assess, pharmacokinetic biomarkers.

To qualify as an index of CNI immunosuppressive activity, a pharmacodynamic biomarker should be directly affected by drug activity, i.e. not too far from the drug target and at the same time close to its clinical effects. As a large amount of evidence supports the concept that T cell suppression is the key mechanism by which CNI achieve immunosuppression to prevent cellular rejection, T cell function and activation are attractive candidates for pharmacodynamic monitoring strategies. However, so far no single pharmacodynamic (PD) biomarker has met all the ideal requirements, i.e. non-invasiveness, reliability, sensitivity, specificity, reproducibility and short analytical time.

Objectives and populations

To search for suitable PD biomarkers, i.e., with high specificity for calcineurin inhibition and most affected by inter-individual variability, our works aimed at exploring the pharmacodynamics of CNI, the strength and variability of signal translation along the calcineurin pathway, as well as the steps where sources of internal (genetic) or external variability are the most influential. In order to achieve this, we assessed simultaneously NFAT1 translocation into the nucleus of peripheral blood mononuclear cells (PBMC) (NFAT1 being the main NFAT isoform in resting and activated lymphocytes), the intracellular expression of IL-2 in CD3⁺, CD4⁺ and CD8⁺ T cell subsets and the membrane



expression of CD25 (IL-2R α), a surface marker of T cells activation, in T cells at large. A non-interventional clinical trial was set up in healthy volunteers, patients registered on a liver transplantation waiting list (WLP) and liver transplant recipients (LTR). A different question was addressed in each group: The healthy volunteer study (n=35): explored TAC PD along the calcineurin pathway by exposing PBMC ex-vivo; modelled signal translation along this cascade; examined the interindividual variability of TAC PD parameters; and investigated the sources of the variability observed and their contribution at each step of the calcineurin pathway. Furthermore, it allowed us to evaluate the analytical variability of our techniques as well as the intra-individual variability of TAC PD parameters. WLP (n=19) were enrolled to confirm in patients with liver diseases the results obtained in healthy volunteers, as well as to test the potential influence of their initial disease on the ex-vivo pharmacodynamics of TAC. The aims of the transversal study of LTR on CNI (n=80) were to further explore the interindividual variability in the PD of CNI in realistic clinical conditions, i.e. in situations of residual PD activities under tacrolimus or cyclosporine exposure, and the potential pharmacogenetic (PG) sources of such variability. The (still small) group of liver transplant patients (n=6) enrolled immediately before transplantation and followed-up with serial monitoring along the first year post-transplantation was intended to explore the relationships between CNI PD and clinical responses.

Material and methods

We measured by flow-cytometry the presence of NFAT1 translocated in the nucleus of PBMC (very close to calcineurin phosphatase activity and probably more specific than “direct” activity measurement that requires inhibiting other phosphatase activities), as well as T cell function (IL-2) and activation (CD25) as final markers of the cellular immune status. PBMC were separated from whole blood samples drawn in fasting conditions and pre-dose by gradient of centrifugation. Fresh PBMC aliquots of 10⁶ cells in 100 μ l of supplemented RPMI were employed for all the determinations. PBMC from healthy volunteers and WLP were exposed ex-vivo for 30 min to TAC concentrations ranging from 0 to 50 ng/ml prior to launching each assay.



NFAT1 measurement was preceded by polyclonal stimulation with phorbol 12-myristate 13-acetate (PMA) 50 ng/ml and calcium ionophore (I) 2.5 µg/ml at 37°C in a humidified atmosphere with 5% CO₂ for 30 min to guarantee NFAT1 translocation to the nucleus. After two washes with cold PBS 1X, cells were incubated 30 min on ice with PIPES lysis buffer (pH 7.4 in PBS 1X) to permeabilize nuclei. Subsequently to two extra washes with BSA 1% in cold PBS 1X, 50 µL of a mix of anti-NFAT1 antibodies at 5 µg/ml in PBS 1X was added to the medium for another 30 min incubation on ice and then stained with PE polyclonal IgG (Goat F(ab')₂ fragment anti-mouse IgG(H+L) at 0.33%. After 15 min incubation on ice in the dark, the resulting fluorescent signal of labeled PBMC nuclei was measured by flow cytometry, and the mean NFAT1 fluorescence intensity in the separated nuclei used for statistical analysis.

Intracellular IL-2 determination required 5h of polyclonal activation with PMA/I and brefeldin 1 µg/ml to stop protein secretion at 37°C in a humidified atmosphere with 5% CO₂. Cells were then: i) stained with anti-human T lymphocyte surface markers (CD3 PerCP-Cy5.5, CD4 FITC, CD8 PE-Cy7); ii) fixed; iii) permeabilized (IntraPrep); iv) labeled with PE Rat Anti-Human IL-2 and PE Rat IgG2a κ as isotype control; and v) analyzed by flow cytometry.

For CD25 expression measurement, PBMC aliquots were incubated for 72h at 37°C and 5% CO₂ in the presence of 7.5 µg/ml Concanavalin A in RPMI 1640 1X. After two additional washes in PBS 1X, direct staining was performed using: CD3 PerCP-Cy5.5, CD4 PE, CD8 PE-Cy7 and CD25 APC. After 30 min of incubation in darkness, and two washes with BSA in PBS 1X, flow cytometry analysis was performed.

In addition, for WLP and LTR an aliquot of PBMC was analyzed for NFAT1, IL-2 and CD25 without ex-vivo stimulation (NS condition).

IL-2 and CD25 expression in the different cell subsets was reported as the percentage of fluorescence-positive cells over the total number of CD4⁺, CD8⁺ or CD3⁺ cells, respectively. The flow cytometers employed during this research were an LSRFortessa and a Canto II systems (Becton-Dickinson), each equipped with 3 lasers. Lymphocytes were chosen as an internal biological control population in order to place adequately the light scatter settings of the flow-cytometer.



As the stability of antigen expression of CD4⁺ T cells across individuals has been well established, we decided to 50.000 events in CD4⁺ as our stopping gate for IL-2 and CD25 measurements. The specificity of our markers was guaranteed by the design of our experiments, the targeted cell subsets, antibodies and fluorochromes chosen, as well as by our gating strategies. Our technique sensitivity was determined by the principle of fluorescence minus one control (i.e., where all antibodies are present in the tube except the one of interest in each case), giving LOD/LOB (limit of detection/limit of blank) values of 0.2% for IL-2⁺CD4⁺, 0.2% for IL-2⁺CD8⁺ and 0.2% for NFAT1 (data obtained from the healthy volunteers study). The technique was validated by analyzing 5 replicates in each of 5 healthy volunteers, each day for 3 consecutive days. For most of the biomarkers, replication on the second and third days was not possible, due to abrogated expression, thus invalidating the trial. However, we were able to demonstrate excellent intra-day analytical reproducibility.

More than 20,000 images were analyzed using the same strategy for all the biomarkers in order to minimize gating variability. The FLOWJO flow-cytometry computer algorithm allowed us to merge and to study simultaneously a larger number of images in a versatile and highly operative environment.

*To examine the contribution of the pharmacogenes to CNI PD variability, we focused on the polymorphisms located: (i) within the promoter regions of the genes coding calcineurin subunits (PPP3R1; PPP3R2; PPP3CA; PPP3CB) and immunophilins [cyclophilin A (PPIA) and FKBP12], as they could affect their transcription; and (ii) in the exons and introns of other genes encoding the proteins directly associated to downstream signaling in the calcium/calcineurin/NFAT cascade. We used Sanger sequencing for the former and RT-PCR for the latter. NFAT1, NFAT2 and PPP3CA genes were mapped for the motifs involved in the protein interactions required for NFAT dephosphorylation and then for its translocation into the nucleus. Regarding CNI metabolism genes, members of the CYP3A enzyme family are the most abundant CYPs in human liver and small intestine. In particular, a variant in intron 3 of CYP3A5 (A6986>G rs776746) has been systematically linked to TAC dose requirements and trough blood levels. In addition, CYP3A4 variants may participate in TAC pharmacokinetic variability, especially a SNP in intron 6 (rs35599367 C>T; CYP3A4*22 TT) which has been associated with a reduced expression of CYP3A4 mRNA in the liver and lower tacrolimus dose requirement compared to wild*



type carriers (*1*1, CC). In our study, we examined the influence on CNI exposure of: recipient and donor CYP3A5*3 genotype, donor CYP3A4*22 as well as recipient ABCB1 genotypes and their corresponding haplotype.

For all the variables and groups studied, distribution normality was tested using the Shapiro–Wilk test and, when needed, data were log-transformed. Flow cytometry results were analyzed vs. the logarithm of TAC concentration using sigmoidal inhibition models (GraphPad PRISM®), to derive basal activity (I_0), 50% inhibitory concentration (IC_{50}), and maximal inhibition (I_{max}). IL-2 in $CD4^+$ and $CD8^+$ cells and CD25 in $CD3^+$ cells were studied as a function of NFAT1 expression, testing a large variety of models classically employed for enzyme inhibition or receptor response, as well as simpler linear and nonlinear regression models. In all cases, we evaluated goodness of fit using nonparametric tests. The influence of gene polymorphisms was examined with R software version 2.15.1. Conformity of genotyping data with Hardy–Weinberg equilibrium was verified using the Fisher exact test with the “SNPassoc” package. Linkage disequilibrium between polymorphisms was investigated for PPP3R1 rs72174030, rs4347819 and rs4519508 and for IL2RA rs10795791, rs11594656 and rs35285258, and the most probable haplotypes were inferred using the “haplo.stat” package. The relations between single nucleotide polymorphisms (SNPs) or haplotypes and TAC pharmacodynamic parameters (I_0 , IC_{50} , and I_{max}) for the different biomarkers were explored using multiple linear regression. We compared recessive, dominant and log-additive genetic models on the basis of the Akaike information criterion. SNPs or haplotypes significant ($P < 0.05$) in univariate analysis were included in an intermediate multivariate model and retained in the final multivariate model only if they survived backward selection on the basis of the Akaike criterion. Bonferroni correction was applied to the final models to account for multiple testing. We estimated the percentage of variability explained by the SNPs or haplotypes in these final models through their R^2 coefficients calculated using ANOVA as the ratio of variability associated to the variable and total variability.

For the transversal group of LTR, we conceived a model based on the steps of the calcineurin pathway, and we fed it with the covariates that we understood were the most pertinent at each step. The relations between SNPs or haplotypes and the different pharmacodynamic biomarkers were also investigated using multiple linear regression and criteria similar to those described for healthy volunteers and WLP. Bonferroni



correction was applied to the p values of the final models to account for the 5 tests performed for the physiopharmacological (unstimulated) conditions and the 6 tests after mitogenic stimulation of PBMC. The percentage of variability explained by the SNPs or haplotypes in these final models was also estimated by ANOVA.

The different populations enrolled in the 3PIGREF clinical trial were analyzed in the intention-to-treat approach.

Results

A total number of 35 healthy volunteers and 87 patients (including 19 from the waiting list) were enrolled. From the 14 patients of the waiting list included in the study and who underwent transplantation, only 6 had serial monitoring over more than two visits; however, two of them were rapidly switched to everolimus and terminated their participation in the study. Six other patients were enrolled immediately after transplantation (instead of before) and were followed-up, but two of them were also switched to everolimus early and left the study. As the management of this cohort was quite difficult because of imponderable post-transplantation complications and of the limited number of individuals left for the statistical analysis, the preliminary results of this part of the research are not presented in this work, and this arm of the investigation will be pursued to include larger number of patients to allow proper statistical assessment.

This work has produced several new findings. After complete exploration of the calcineurin pathway by simultaneous PK/PD/PG approach in humans or in human cells ex-vivo, it showed that TAC pharmacodynamics was consistent from NFAT1 in PBMC nuclei down to CD25 in several T cell subsets, following an I/I_{max} model at each step, and that IL-2 and CD25 responses depended on inhibition of NFAT1 nuclear translocation in PBMC, following an allosteric sigmoid model. Intra-day analytical reproducibility yielded coefficients of variation at physiological levels (I_0) less than 9%. The intra-individual variability estimated in 3 healthy volunteers ranged from 3.2 to 6.5% for I_0 and from 8.6 to 17% for IC_{50} (except for NFAT1, IC_{50} CV = 50%). I_0 levels of the different biomarkers showed moderate, and IC_{50} and I_{max} much larger, variability.



After log transformation of all parameters (as most were not normally distributed), mild to moderate inter-individual variability was found for the I_0 values (CV = 11% to 20%) as well as for NFAT1 and CD25 I_{max} values (CV = 14%), whereas inter-individual variability was much larger for IL-2 I_{max} in CD4⁺ and CD8⁺ cells (CV = 71% and 195%, respectively), two readouts very close to the detection limit of the technique (0.2%). Hence, we set-up a repeatable technique for this study as evidenced by its overall low to mild analytical variability, which was less than the intra-individual and inter-individual variability and consistent with what other researchers described (although comparisons are difficult owing to different markers, cell types and experimental schemes). The pharmacogenetic association study in healthy volunteers suggested that the wild type haplotype of three SNPs present in the CD25 coding gene downregulates (in stimulated conditions) the expression of IL-2 in CD4⁺ cells and when mutated it downregulates CD25 expression in T lymphocytes. A variant within the promoter region of cyclophilin diminishes tacrolimus IC_{50} for NFAT1 nuclear translocation, whereas IL-2 expression in CD4⁺ T cells I_{max} seems to be increased by the nucleotide triplet (GCC)_{10/10} polymorphism in the calcineurin catalytic subunit promoter.

In WLP, after log transformation of all parameters we found mild to moderate inter-individual variability (CV = 17% to 28%) of I_0 (without TAC exposure but in stimulated conditions) for NFAT1 and IL-2 in CD4 T cells, while much larger inter-individual variability was found for all biomarkers at tacrolimus IC_{50} , as well at I_0 unstimulated, physiological levels (except for NFAT1, CV = 12%). Interestingly, the inter-individual variability of I_{max} was low in the case of NFAT1 (CV = 8.9%), moderate for CD25 (CV = 20, 33 and 33% for CD3⁺, CD4⁺ and CD8⁺, respectively), and the largest for IL-2 (CV = 206% and 58% for CD4⁺ and CD8⁺, respectively). At TAC maximal inhibition, NFAT1 in PBMC nuclei, IL-2 in CD8⁺ T cells and CD25 in T cell subsets showed incomplete inhibition. TAC IC_{50} augmented along the CaN pathway, from a geometric mean of 0.6 ng/ml for NFAT1 up to 1.3 ng/ml for CD25^{high} in CD4 and CD8dim. Individual IC_{50} values varied 100-fold for NFAT1, 200-fold for CD25 in CD4⁺, 300-fold for IL-2 and CD25 in CD8⁺ cells, 600-fold for IL-2 in CD4⁺ cells, and 1000-fold for CD25 in T lymphocytes. As in healthy volunteers, an allosteric sigmoidal relationship between IL-2 and CD25^{high} with NFAT1 in PBMC nuclei was found here in patients on the LT waiting list. PPP3CA C149278688A SNP accounted for 77% of the variability of NS I_0 levels of NFAT1 in PBMC nuclei ($p=0.0019$);



PPIA G6850A explained 78% of $CD25^{High}CD3dim$ NS I_0 variability; PPIA G8177826C 83% of $CD25^{High}CD4dim$ I_0 variability; IL2RA T35285258C 94% of $CD25^{High}CD8dim$ IC_{50} variability; and IL2RA T11594656A 96% of $CD25^{High}CD4dim$ I_{max} variability.

The study of LTR on TAC showed that the unstimulated levels of NFAT1 in PBMC nuclei (individual values in a 10-fold range), intracellular IL-2 in $CD4^+$ T cell subset and CD25 expression in $CD8^+$ T cells (20-fold range) exhibited mild to moderate interindividual variability, whereas variability in IL-2 expression in $CD8^+$ T cells (400-fold), CD25 in $CD4^+$ (300-fold) and $CD3^+$ (500-fold) cells was very large. In comparison, the interindividual variability of stimulated markers was lower, except for CD25 and IL-2 in $CD8^+$ T cells (100-fold each). Stimulated levels of IL-2 and CD25^{High} in $CD8^+$ T cells showed the largest variability, lower CV% values were found for CD25^{High} in $CD3^+$ and $CD4^+$ T cells, and NFAT1 in PBMC nuclei exhibited the lowest variability (similar to unstimulated conditions). Moreover, none of the PD biomarkers was completed inhibited, except IL-2⁺ $CD4^+$ in unstimulated conditions. None of the biomarkers downstream NFAT1 nor any other covariate apparently influenced TAC PD in LTR.

In LTR on CsA, non-stimulated and stimulated levels of NFAT1 in PBMC nuclei exhibited mild to moderate interindividual variability (CV = 15%, corresponding to a 9-fold range), whereas larger values were observed for IL-2 in stimulated and non-stimulated $CD4$ T cells, CD25 in stimulated $CD3$ and $CD4$ lymphocytes and in non-stimulated $CD8$ lymphocytes (CV between 49 and 82%). However, much higher CV% values were found for IL-2 in stimulated $CD8$ T cells (CV = 127%) and above all for CD25 in stimulated $CD8$ T cells (CV = 355%), and in non-stimulated $CD3$ and $CD4$ T lymphocytes (CV between 644 and 10089%). As a consequence, the inter-individual variability of stimulated markers was less than or equal to that of “physio-pharmacological” levels, except for IL-2⁺ $CD4^+$ and $CD25^{High}CD8dim$. Multivariate analysis revealed that recipient age positively correlates with the unstimulated levels of NFAT1⁺ in PBMC nuclei as well the wild-type allele of ABCB1 T1128503C upregulates IL-2 expression in $CD8^+$ T cells and that HCV etiology increases $CD25^{High}$ expression in stimulated $CD8^+$ T cells. On the contrary, the mutated allele in the promoter region of cyclophilin A G8177826A downregulates IL-2 expression in $CD4^+$ and $CD8^+$ and in $CD25^{High}$ in $CD3^+$ stimulated T cells. Furthermore a mutated allele in the promoter region of calcineurin regulatory subunit PPP3R1 T4519508C increases the expression of $CD25^{High}CD4^+$ stimulated T cells. Together with the influence of HCV pre-



transplantation status, polymorphism in ABCB1, PPIA and PPP3R1 emerged as relevant determinants of CsA pharmacodynamics after Bonferroni's correction. ABCB1 1128503T explained 74% of the variability of non-stimulated IL-2⁺CD8⁺, PPP3R1 4519508T 80% of that of stimulated CD25^{High} expression in CD4⁺ T cells and HCV 76% of the variability of stimulated CD25^{High} expression in CD8⁺ T cells. Furthermore, PPIA 8177826G accounted for 87% of the variability in IL-2⁺CD4⁺, 77% of that of IL-2⁺CD8⁺ and 83% of the variability of CD25^{High}CD3dim lymphocytes in stimulated conditions. No significant influence from donor genetic characteristics on CsA PK was found.

As shown above, some of these TAC and CsA PD biomarkers could be measured without ex-vivo stimulation (NS), which may reflect more faithfully their actual pharmacological activity than after mitogenic stimulation (stim). These biomarkers were not influenced by TAC or CsA doses or trough blood levels, and displayed a large inter-individual variability in both NS and stim conditions.

Discussion

After calcineurin activation, NFAT proteins are dephosphorylated and released from their repression mechanism enabling their translocation into the nucleus where, in the presence of the AP1 cooperative protein partner, they trigger the transcription of target genes, including IL2 and IL2R α . Our hypothesis was that the inhibition of NFAT1 nuclear translocation by CNI would be an informative biomarker of CaN/NFAT pathway signaling, in particular more specific of the immunosuppressive activity of CNI than the inhibition of calcineurin activity itself, the measurement of which requires inhibiting many other phosphatases. IL-2 acts as the principal growth factor for T lymphocytes, regulating the magnitude and duration of the T cell immune response following an antigenic stimulus. Intracellular IL-2 expression by different T cell subsets was previously assessed to monitor the extent of tacrolimus pharmacological response, with the assumption that if this cytokine is downregulated lymphocyte activation should be as well. Calcineurin also controls the expression of certain T cell surface receptors, through NFAT-induced gene transcription. In particular, the expression of CD25, the high-affinity inducible IL-2 α chain receptor, remains low in resting T cells and is upregulated early upon TCR activation. Moreover, together with IL-2 it forms a positive auto-regulatory



loop to ensure T cell activation. IL-2 and CD25 can thus be combined as tools to assess T cell responsiveness.

During an acute inflammatory state, the recipient immune response is directed by the balance of two opposing forces, the pro-inflammatory (Th1) reaction (involving the cytokines IL-2 and IFN γ), which recruits inflammatory cells to damaged sites and the anti-inflammatory response (led by TNF α , IL-1 β and IL-6), whose role is to limit tissue injury and promote healing. Monocytes and lymphocytes participate in both reaction mechanisms. The resulting balance of these two cascades determines the extent of host inflammatory reaction and clinical outcomes. Although most pro-inflammatory and immunoregulatory cytokines are upregulated during acute cellular rejection (ACR) of the transplant, they cannot distinguish between ACR and infections, limiting their clinical utility. In organ transplantation one of the purposes of anticalcineurin drugs is to reduce IL-2 production (T cell function and consequently T cell activation), in order to minimize inflammation and graft rejection. It has been reported that IL-2 levels in serum or plasma are not accurate to diagnose rejection. On the contrary, as significant association between IL-2 expression in lymphocytes infiltrating the liver graft and ACR has been reported, intracellular IL-2 expression in PBMC may thus better reflect CNI immunosuppressive effect in allograft recipients.

In our research, IL-2 expression in Th1 cells of LTR on TAC was quite elevated, reaching the same values as in healthy volunteers without exposure to the drug. This points out to the existence of an activated/inflammatory status in the patients, probably linked to the immunological conflict between the graft and the recipient immune system, despite the action of immunosuppressants. Moreover, previous studies by Canivet et al. showed that CD25 expression by T cells was diminished in patients with liver disease on a waiting list for liver transplantation, which our study confirmed. This might partly explain the lower requirements of immunosuppression in LTR compared to recipients of other allografts. Besides, in our population, LTR with CD25^{High}CD4dim levels < 1.2% without stimulation, or < 3% after mitogen stimulation, further developed at least one episode of rejection. We found a significant association between pre-transplant HCC and unstimulated CD25^{High}CD8dim levels, which is coherent given that CD8⁺ cytotoxic cells contribute to HCC development. Both CD8⁺ and NKT cells induce liver damage, and NF κ B participates in the transition towards HCC.



Previous studies have discussed the influence of donor and recipient age on graft survival, owing to functional changes in white blood cells which may be partially responsible for cellular and humoral immunodeficiency in the elderly. Böhler et al. postulated that age exerts an influence on specific T cell functions and that the increase of pro-inflammatory cytokine expression with age would affect allograft survival. Furthermore, they suggested that the positive correlation between CD25^{High} activated T cells and age they found in transplant patients may upregulate T cell proliferation in response to IL-2. We also found a positive correlation between recipient age and CD25^{High} expression in unstimulated CD3⁺ and CD4⁺ T cells in LTR on TAC. On the other hand, like Böhler et al. and Lemaitre et al., we did not find any significant relationship between tacrolimus trough levels and biomarkers of T cell function or activation.

Different variants within the promoter region of cyclophilin A and within the catalytic and regulatory calcineurin subunits are capable to influence T cell activation and function (measured either with or without ex-vivo stimulation). Recipients carrying the wild type allele of ABCB1 (coding the P-gp drug efflux protein) had increased T cell function and activation. Previous researches have emphasized the important influence of CYP3A5 expression in both the graft liver and the native intestine. Indeed, recipients carrying only the intestinal CYP3A5*1 genotype already required higher doses of tacrolimus and show lower tacrolimus concentration/dose ratio than non expressors. In liver transplantation, where the recipient's intestinal and the donor's hepatic CYP3A5 enzymatic activities may synergize in overall drug disposition, there is added value of assessing both, better before or during the transplantation procedure in order to optimize the CNI starting dose.

Further sources of variability of T lymphocyte response to CNI, related to TCR, CaM, calcineurin, expression of different NFAT isoforms, IL-2, as well as physiological levels of T lymphocytes and Tregs have been identified. The differences in drug responses are probably due to high interindividual variability at all levels of this complex web. CaN activity is too high in this network to integrate these sources of variability, and NFAT1 translocation probably as well. On the contrary, IL-2 and CD25 probably integrate most of these sources. Furthermore, as they are responsible for T cell function and activation respectively, they are closer to the immune response and their determination might better predict clinical outcomes.



To conclude our main results in healthy volunteers' PBMC ex-vivo study showed: that the inhibition of NFAT1 in PBMC nuclei and of IL-2 and CD25 expression in different subsets of T lymphocytes followed I/I_{max} model; that IL-2 and CD25 responses to NFAT1 inhibition fitted an allosteric sigmoid model; and that several polymorphisms in genes involved in CNI PD participated in the inter-individual variability of these biomarkers. In patients on the waiting list of liver transplantation we were able: to measure CNI PD parameters without as well as with ex-vivo stimulation, hence probably addressing the residual activity and immunological reserve capacity of the PD biomarkers after exposure to increasing concentrations of tacrolimus, respectively; to show PG/PD relationships, as well as PD/PD interactions within the pathway. LTR on CsA showed more inter-individual PD variability than those on TAC and apparently different regulations within the pathway.

In summary, IL-2 and CD25 in CD8⁺ T cells and CD25 in CD4⁺ T cells may be reliable biomarkers of CNI activity, with the largest inter-individual variability. Moreover, a few clinical cases suggest that NFAT1 levels in PBMC nuclei might help to anticipate infection episodes, while Tregs diminution and high levels of IL-2 expression in CD8⁺ T cells might predict acute cellular rejection.



Contents

<i>Remerciements</i>	3
<i>Droits d'auteurs</i>	7
<i>Résumé</i>	8
<i>Summary</i>	21
Contents	33
Introduction	38
I. CALCINEURIN PATHWAY	42
<i>I.1. T CELL ACTIVATION</i>	<i>42</i>
<i>I.2. CALCIUM SIGNALS</i>	<i>47</i>
<i>I.3. CALMODULIN: A VERSATILE Calcium SENSOR</i>	<i>54</i>
<i>I.4. CALCINEURIN</i>	<i>56</i>
<i>I.5. IMMUNOPHILINS</i>	<i>61</i>
II. THE NFAT FAMILY	66
<i>II.1. NFAT STRUCTURE AND ACTIVATION</i>	<i>68</i>
<i>II.1.1. NFAT Dephosphorylation/Activation</i>	<i>68</i>
<i>II.1.1.1 Calcineurin docking</i>	<i>70</i>
<i>II.1.1.2. Calcineurin – NFAT interaction</i>	<i>71</i>
<i>II.1.1.3. Transactivation domain</i>	<i>73</i>
<i>II.2. NFAT REGULATION: CALCIUM, CALCINEURIN AND NFAT KINASES</i>	<i>74</i>
<i>II.2.1. NFAT translocation model</i>	<i>74</i>
<i>II.2.2. NFAT Kinases: NFAT phosphorylation</i>	<i>76</i>
<i>II.2.3. NFAT Transport regulation</i>	<i>79</i>
<i>II.2.3.1. Importins and Exportins</i>	<i>79</i>
<i>II.2.3.2. Polyribosylation</i>	<i>79</i>
<i>II.2.3.3. RNA-protein scaffold complex</i>	<i>79</i>
<i>II.2.3.4. Sumoylation</i>	<i>80</i>
<i>II.2.3.5. 14-3-3 binding: a key regulator of signal transduction events</i>	<i>82</i>



II.2.3.6. Other mechanisms modulating NFAT trafficking	82
II.3. NFAT2 SELFREGULATION: AN ISOFORM-SPECIFIC MECHANISM.....	83
II.4. NFAT TRANSCRIPTIONAL ACTIVITY	85
II.4.1. CaN/NFAT signaling and Thymocyte development	89
II.4.2. NFAT and T helper differentiation	89
II.4.3. NFAT and T regulatory FOXP3 cells	91
II.4.4. NFAT control of T cell fate: Activation or Anergy?	94
II.4.5. Redundant vs. non-overlapping functions of NFAT proteins	96
II.5. NFAT AND INNATE IMMUNITY	98
II.6. ONCOGENIC POTENTIAL OF NFAT SIGNALING	99
III. CALCINEURIN/NFAT REGULATORS	105
III.1. NEGATIVE REGULATORS OF T CELL ACTIVATION.....	105
III.2. ENDOGENOUS REGULATORS OF CALCINEURIN.....	111
III.3. OTHER REGULATORS OF THE CALCINEURIN/NFAT PATHWAY.....	114
III.3.1. Tob-SMAD Complex.....	114
III.3.2. DREAM Transcriptional repressor	114
III.4. EXTRINSIC INHIBITORS OF CALCINEURIN/NFAT SIGNALING: ANTICALCINEURIN DRUGS	116
IV. INTERLEUKIN 2.....	118
IV.1. INTERLEUKIN 2 SIGNALING.....	118
IV.2. IL-2 SIGNALS CONTROL CD4⁺ T CELL SUBSETS	121
IV.3. IL-2 OPTIMIZES CD8⁺ T CELL RESPONSES.....	123
IV.4. IL-2 HOMEOSTASIS	124
IV.4.1. FOXP3 Transcription factor: a Negative regulator of IL-2.....	124
IV.4.2. SIVA gene: Negative regulator of IL-2.....	124
IV.5. INTRACELLULAR IL-2 EXPRESSION AND ACUTE REJECTION	124
V. INTERLEUKIN 2 ALPHACHAIN RECEPTOR, Surface Marker of Activated T Cells	125
V.1. CD25 SIGNALING	125
V.2. IL-2Rα TRANSCRIPTIONAL REGULATION.....	127



I. PHARMACODYNAMIC INVESTIGATIONS - JUSTIFICATION	130
II. PHARMAOGENETIC INVESTIGATIONS - JUSTIFICATION	132
II.1.PROMOTER SEQUENCING.....	134
II.2.GENOTYPING STRATEGY.....	134
II.3.BINDING SITES VARIANTS OF NFAT1, NFAT2 AND PPP3CA	135
II.3.1.NFAT Mapping	135
II.3.2.PPP3CA Mapping	136
II.4. DONOR–RECIPIENT SECREENINGS AND CNI METABOLISM	136
II.4.1. ABCB1 Transmembrane Multi Drug Resistant Pump (P-gP).....	137
II.4.2.CYP3A5	138
II.4.3.CYP3A4*22	140
III. MATERIALS and METHODS.....	141
III.1.PHARMACODYNAMIC RESEARCH	141
III.1.1. Study design and subjects - 3PIGREF Clinical trial	141
III.1.2.Chemicals and reagents	141
III.1.3.PBMC Separation	142
III.1.4.Ex-vivo TAC exposure in Healthy Volunteers	142
III.1.5.NFAT1 translocation to the nucleus of PBMC cells.....	142
III.1.6.Intracellular IL-2 expression in CD4 ⁺ and CD8 ⁺ T cell subsets	143
III.1.7.IL-2R α expression at the surface of CD3 ⁺ T cells	143
III.2. PHARMAOGENETIC STUDY	144
III.2.1.Promoters sequencing.....	144
III.2.2.Genotyping assays	147
III.2.3.Binding Site Variants of NFAT1, NFAT2 and PPP3CA	148
III.2.4. Donor – Recipient Pharmacogenetics of CNI metabolism and transport proteins: ABCB1, CYP3A5 and CYP3A4*22	149
III.3. STATISTICAL METHODS	151
III.3.1 Healthy Volunteers and Patients of the Waiting List for Liver Transplantation	151
III.3.2. Transversal Group of Liver Transplant Patients	152



IV. RESULTS	153
<i>IV.1.HEALTHY VOLUNTEERS (ARTICLE N°2).....</i>	<i>154</i>
<i>IV.2.BINDING SITE VARIANTS of NFAT1, NFAT2 and PPP3CA.....</i>	<i>157</i>
<i>IV.3. REPLICATION OF PK/PD/PG STUDY IN PATIENTS OF THE WAITING LIST (ARTICLE N°3 - DRAFT) ...</i>	<i>158</i>
IV.4. LIVER TRANSPLANT PATIENTS TRANSVERSAL GROUP	171
<i>IV.4.1. LIVER TRANSPLANT RECIPIENTS on TACROLIMUS (ARTICLE N°4 – DRAFT).....</i>	<i>171</i>
<i>V.4.2.LIVER TRANSPLANT PATIENTS on CYCLOSPORINE (ARTICLE N°5 - DRAFT)</i>	<i>202</i>
IV.5. LONGITUDINAL COHORT OF LIVER TRANSPLANT PATIENTS.....	214
V. DISCUSSION.....	215
<i>V.1. PD BIOMARKERS OF CALCINEURIN AND T CELL RESPONSIVENESS</i>	<i>215</i>
V.2.PRE ANALYTICAL CONSIDERATIONS	216
<i>V.2.1.Stimulating Agents.....</i>	<i>216</i>
<i>V.2.2.AntiCD4 Antibody Clone.....</i>	<i>216</i>
V.3. ANALYTICAL CONSIDERATIONS	219
<i>V.3.1.Flow Cytometry Performance and Standardization</i>	<i>219</i>
<i>V.3.2.Flow Cytometry gating strategy</i>	<i>221</i>
<i>V.3.3. Assay Validation.....</i>	<i>221</i>
V.4. POST ANALYTICAL CONSIDERATIONS	223
V.5. NEW DISCOVERIES IN TAC PK/PD/PGX RELATIONSHIPS	223
V.6. FURTHER SOURCES OF VARIABILITY OF CNI.....	228
REFERENCES.....	232
Abbreviations.....	247
SUPPLEMENTAL MATERIALS	259
S1.STRATEGY FOR THE STUDY OF POLYMORPHISMS IN NFAT and CALCINEURIN CRITICAL REGIONS OF INTERACTION	259
<i>S1.1.NFAT CRITICAL REGIONS OF INTERACTION WITH CaN and OTHER PROTEINS.....</i>	<i>259</i>
<i>S1.2.PPP3CA CRITICAL REGIONS OF INTERACTION WITH NFAT and OTHER PROTEINS</i>	<i>263</i>



S2.FLOW CYTOMETRY GATING STRATEGY	266
S2.1.NFAT1 in PBMC Nuclei.....	266
S2.2.Intracellular IL-2 in CD4 ⁺ and CD8 ⁺ T cell subsets	266
S2.3.CD25High in CD3dim, CD4dim and CD8dim T cell subsets	267
S3. PUBLISHED ARTICLE ABOUT EX-VIVO TACROLIMUS PHARMACODYNAMICS IN HEALTHY VOLUNTEERS' PBMC.....	268
S4.TAC INDIVIDUAL PD PARAMETERS IN WLP	270
S5.VALORISATION DES COMPÉTENCES, Nouveau Chapitre de la Thèse	276



Introduction

The calcineurin inhibitors (CNI) cyclosporine and tacrolimus are the immunosuppressants mostly used for preventing graft rejection in solid organ transplantation, alone or combined with other immunosuppressive (IS) drugs. Combined therapies enhance T cell inhibition through the complementarity of drug actions and help to reduce anticalcineurin drug doses and minimize their side effects.

Despite advances in therapeutic drug monitoring of immunosuppressant drugs, the efficacy and toxicity of these drugs in transplantation remain a great issue. The huge intra and inter-individual variability in drug effects observed in graft recipients, not explained by differences in drug doses, concentration levels or even the area under the concentration-time curve (AUC), represents the limitation of therapeutic drug monitoring and suggests that other factors than drug exposure influence drug response. Overexposure leads to toxicity, whereas concentrations below therapeutic drug levels favor graft rejection, so that the balance of this equation is a transplantologist's fine art because most of the biochemical or immunological biomarkers employed in clinical practice show little association clinical outcomes. Consequently, graft histopathology remains the best practice to diagnose acute and chronic rejection, as well as other graft lesions. However, making graft biopsies is an invasive procedure with all the risks that the recipient must face, and histopathological reading has limitations pertaining to tissue sample characteristics and pathologist expertise.

For the above mentioned reasons, better strategies for treatment optimization are therefore needed; these could include the identification and validation of pharmacodynamic biomarkers or direct measurement of drug concentrations at the target sites, i.e., allograft tissue and lymphocytes.(1)

Different pharmacodynamic (PD) markers of calcineurin (CaN) inhibition have been studied (including calcineurin phosphatase activity, T cell function, T cell activation and gene expression), some of which were correlated with CNI exposure and/or clinical outcome, but none has been fully validated in clinical practice, and their measurement is still time-consuming.(2)



In order to seek for the best panel of biomarkers for diagnosis and /or predictive outcome, it is crucial to obtain results that could reflect their purpose and been robust enough to compare them between different centers. In this objective, analytical methods and equipments should been harmonized or standardized in order to allow comparison of results obtained in different centers. Hence, during the validation process, experiments must be designed in conditions as close as possible to the real assay performed in routine; however, this could raise constraints depending on the starting sample material, such as the feasibility of working with living cells, or the possibility on maintaining biomarker levels as on the day of sampling. It is therefore crucial that biomarkers with potential clinical uses must be robust and reproducible enough under in daily routine conditions.

Different biomarkers at pharmacodynamic, genetic and proteomic levels, have been proposed in order to predict the risk of transplant rejection events.(3)(4)(5)(6)(7)(8)(9)

Rejection being a multifactorial process, its early detection seems to require a panel of markers, rather than a precise indicator which probably would not be able to integrate the miscellaneous contributions to which it is subjected; in this regard, genetic factors maybe involved during the conditioning of the individual response. The evidence compiled up to date in liver transplantation points that eosinophilia (10), calcineurin activity (11) , soluble TGF β (12), intracellular IL-2 and IFN γ expression in CD8 $^+$ T subset (12)(13), V δ 1 $^+$ /V δ 2 $^+$ cells ratio (14), DSA and C4d (9)(15)(16), NFAT residual expression of regulated genes (17), micro RNAs (18)(19) and graft-derived cell-free DNA (20) arise as the most promising biomarkers to predict liver acute cellular rejection. NFAT residual expression of regulated genes (21)(22) and intracellular ATP in CD4 $^+$ T cells (3) are both useful predictors of infection, and the former of malignant processes too. It is noteworthy that some of these markers have failed to prove their predictive utility in liver transplantation (LT); however they showed association in kidney transplantation (KT). Moreover, some of them have proven their diagnostic utility in combination rather than isolated, since they can be expressed in other liver disorders; in this regard, DSA, C4d and intracellular ATP are the most controversial.



Capron et al. showed that diminished tacrolimus concentration in recipient's PBMC associates with clinical rejection.(1) Naturally, TAC exposure is also involved in TAC pharmacodynamics: Vadafari et al. found that the ratio of C_0 TAC over the expression of IL-2 in CD8⁺ T cells in kidney graft recipients (KTR) with *ABCB1* 3435CC genotype was higher compared with mutated allele carriers, meaning that these patients require more CNI to inhibit IL-2 production.(23) Furthermore Dessilly et al., have found in human embryonic kidney recombinant cells that *ABCB1* 1199A mutated allele has a deleterious effect on *ABCB1* ability to pump tacrolimus out of the cell.(24) Sigdel et al. arrived to discriminate nine urine proteins with high specificity for renal acute rejection.(25)

Up to date there is no single biomarker currently available that meets all of the ideal requirements, i.e. non-invasive, reliable, sensitive, reproducible, specific, whose results can be obtained with a reasonable turnaround time to make decisions opportunely. In addition, no study has investigated all the possible PD biomarkers along the calcineurin/nuclear factor of activated T cells (NFAT) pathway.(2)

We believe that the knowledge of the strength and variability of signal translation along the calcineurin pathway, as well as of the steps where sources of internal (genetic or epigenetic) or external (environmental) variability are the most influential, is necessary to select the best PD biomarkers, i.e., those with high specificity for CaN inhibition and most affected by inter-individual variability.(2) Canivet et al. initiated investigations of CNI pharmacodynamics biomarkers in liver transplantation(26) but no study has investigated all the possible PD biomarkers along the calcineurin/nuclear factor of activated T cells (NFAT) pathway.(2) Therefore, the purpose of this research is to study the pharmacodynamic (PD) cascade of CNI immunosuppressive activity, the signal transduction along this calcineurin pathway, the links of these PD biomarkers with CNI dose and systemic exposure, and the pharmacogenetic contributions to CNI pharmacodynamics inter-individual variability.

In a first part of this thesis, we will present a literature review about the extremely complex regulation mechanisms of the calcineurin pathway, in a second part our personal works on the subject and finally conclusions and perspectives. **(ARTICLE N°1 - DRAFT)**



Part I: State of the Art



I. CALCINEURIN PATHWAY

I.1. T CELL ACTIVATION

During T cell activation two different signals are required: one provided by T cell receptor (TCR) in the course of recognition of an antigen peptide presented by the antigen-presenting cells (APC) through binding of the MHC (Major Histocompatibility Complex) and the other resulting from the interaction of co-stimulatory receptors like CD28:B7. Furthermore, a stable immunological synapse at the contact interface between T cell and antigen presenting cell (APC) is mandatory in order to warrant the efficiency of signal transduction. Costimulatory mechanisms modulate the strength of the TCR signal and promote genetic expression of several cytokines like interleukin-2 (IL-2) and factors involved in T cell proliferation and differentiation. TCR engagement triggers the signaling necessary for the transcription of multiple genes committed to direct cell proliferation, immunologic function, and apoptosis. This differentiation process requires almost 2 weeks for completion and cooperation with many cell types to program cell surface homing receptors, cytotoxic molecules, and other secreted proteins required for enabling an effective immune response. One of the destinies of T cells is apoptosis, which is most influenced by the Fas receptor and its ligand; and whose role consists to remove those clones of antigen responsive cells no longer needed.(27)

Antigen recognition by TCR engagement (antigen/MHC complex on APC cells) and CD28 receptors initiates a number of signaling cascades that involves the activation of proximal tyrosine kinases and adaptor proteins in T lymphocytes which ultimately determine cell fate through control of cytokine production, cell survival, proliferation, and differentiation by means of the activation of the transcription factors Nuclear Factor of Activated T cells, Nuclear Factor kappa-light-chain-enhancer of activated B cells (NF- κ B) and Activator Protein 1 (AP1) essential for signal propagation from TCR to the nucleus.(27)(28)

NFAT1 is the principal transcription factor directly activated downstream of the Ca^{2+} /Calcineurin (CaN) interaction which has a critical role in dictating activation or tolerance, two potential outcomes initiated by TCR-MHC contact.



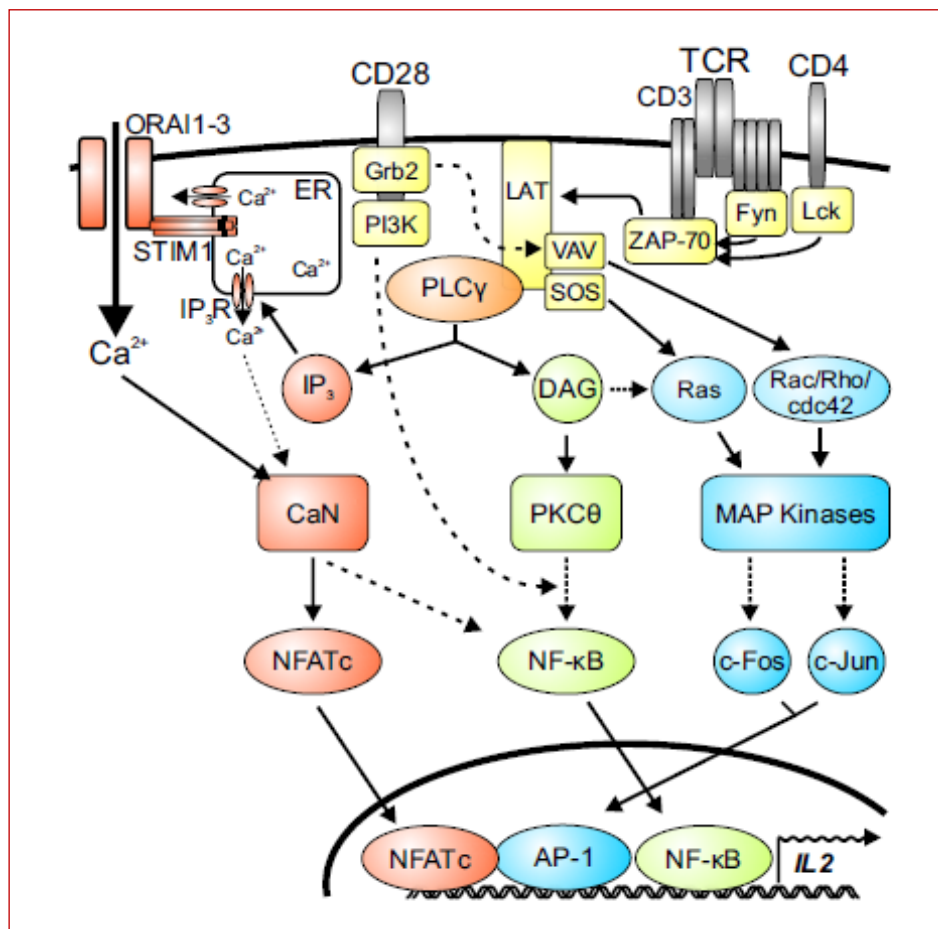

Figure 1. Schematic representation of TCR signalling.(29)

TCR activation also triggers an initial cytoplasmic calcium Ca^{2+} signal via the activation of phospholipase Cy (PLC γ), hydrolyzing phosphatidyl-4,5-bisphosphate (PIP2) into diacylglycerol (DAG) and inositol-1,4,5-trisphosphate (IP3). IP3 binding to its receptor (IP3R) on the endoplasmic reticulum (ER) membrane induces Ca^{2+} efflux from the ER. This depletion is sensed by an N terminal EF-hand protein, the stromal interaction molecule 1 (STIM1), and further transmitted to the STIM1 cytoplasmic domain where it is recognized by stromal interaction molecule 2 (STIM2) to activate the pore forming subunit of the calcium release-activated calcium channel protein 1 channels (Orai1), (in the plasma membrane) which opens the store-operated Ca^{2+} entry (SOCE) channels, allowing a sustained increase of intracellular calcium levels.



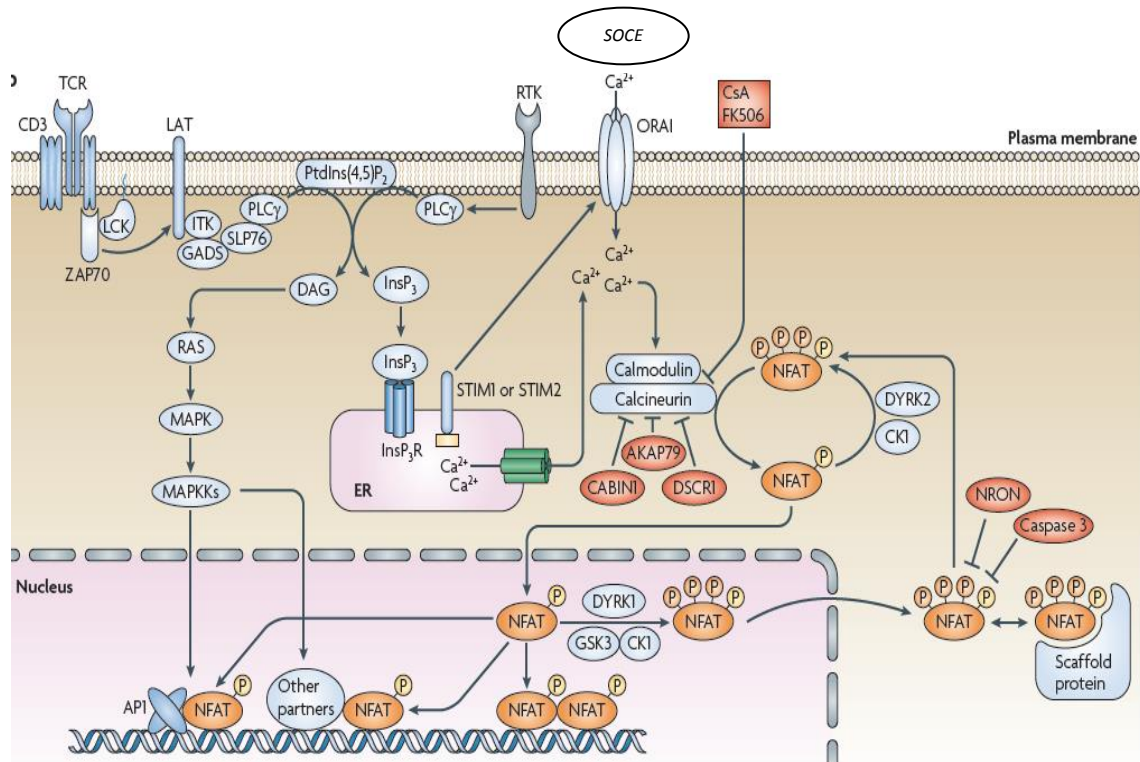

Figure 2. TCR activation and Ca^{2+} signaling.(30)

Calcineurin activity is regulated by several endogenous repressors, like calcineurin-binding protein 1 (CABIN1), calcipressins (CSPs), A-kinase anchor protein 79 (AKAP79) and Down's syndrome critical region 1 (DSCR1),(31) (Figure 2) but also is target of pharmacological inhibitors such as cyclosporine A (CsA) and tacrolimus.(30)

When Ca^{2+} binds to calmodulin (CaM) a calcium sensor protein, activates calcineurin (CaN) and initiates a sequence of downstream signaling events comprising the activation of a family of transcription proteins NFAT by dephosphorylation of conserved phosphoserine residues in their regulatory domain.

This leads to a conformational change which unmasks NFAT's nuclear localization sequence (NLS), enabling NFAT translocation into the nucleus. Once there, NFAT proteins need the cooperation of other multiple transcriptional partners (e.g., AP1) to trigger gene expression through binding to the composite sites of the promoters of its target genes.(30)(32) Ca^{2+} influx increases $[Ca^{2+}]_i$ activating CaN/NFAT cascade as well exerting regulation of other pathways, such as the Ras/MAPK cascade.(33) Ras/ mitogen-activated protein kinase (MAPK) signaling, protein kinase C (PKC) and other ancillary pathways are involved in the activation of NFAT partners after TCR engagement.



Two outputs are possible from Ca^{2+} signals and NFAT transcription factors, one may lead to the control of many cellular processes including gene transcription, protein secretion, cell metabolism and differentiation, and the other to induced cell death or T cell unresponsiveness.(34)

In helper T cells (Th) calcium signaling directs the production of IL-2 and other cytokines implicated in the amplification of the immune response through clonal expansion. If co-stimulation is missing, Ras/MAPK pathway disability leads to deficient AP1 activation, and under these circumstances NFAT proteins could form heterodimers and even complexes with other transcription factors redirecting its activity towards a specific set of anergy-inducing genes.(28) This state of unresponsiveness could also exhibited as a result of sustained calcium signaling through upregulation of other transcription factors, amplifying T helper 1 (Th1) or T helper 2 (Th2) specific gene programs. (35)

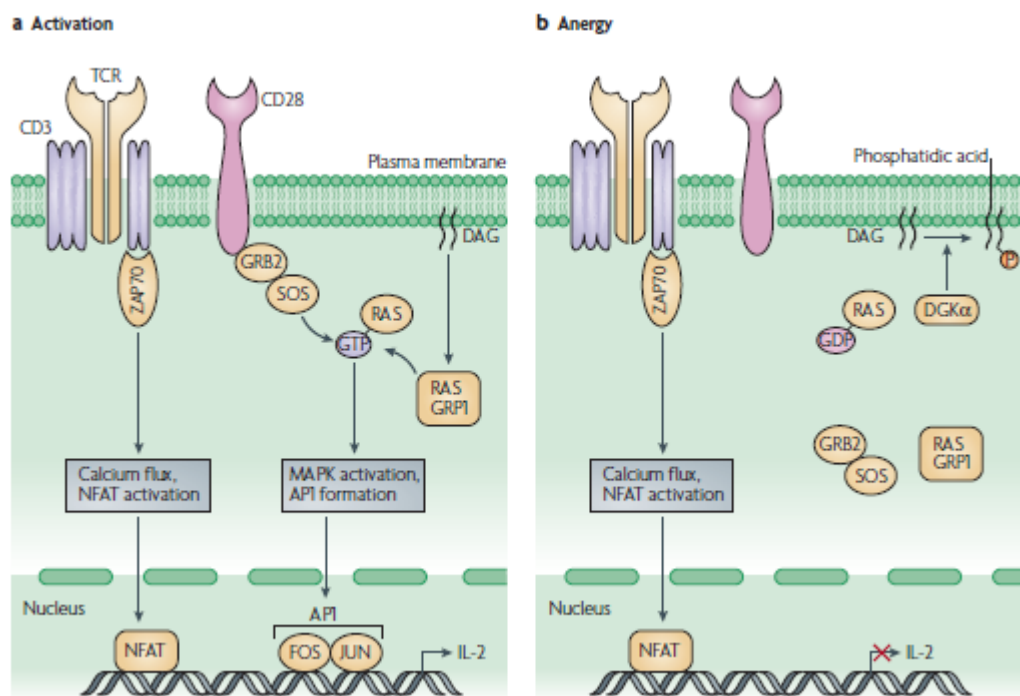

Figure 3. T cell fate according to NFAT transcriptional partners involved upon microenvironmental conditions. (36)



Several kinases, such as glycogen-synthase kinase 3 (GSK3), casein kinase 1 (CK1), and dual-specificity tyrosine-phosphorylation regulated kinase 1 (DYRK1) and DYRK2, help to maintain NFAT phosphorylated in the cytosol (maintenance kinases) or induce NFAT nuclear rephosphorylation commanding the exposure of a nuclear-export signal (NES) to translocate NFAT back to the cytosol (export kinases).(32)(31)(37)

GSK3 is negatively regulated by protein kinase B (PKB/AKT), the activation of which is linked to CD28 engagement, a critical costimulatory factor for proper T cell activation which also binds B7.1 and B7.2 molecules expressed on antigen-presenting cells.(31)

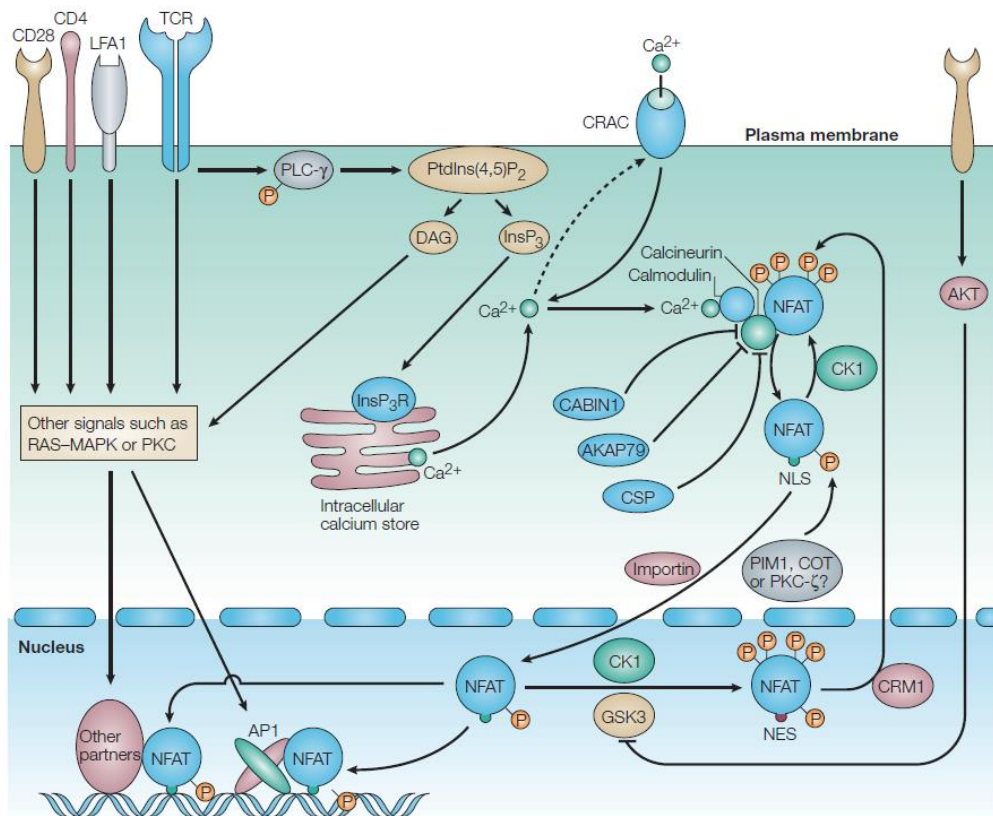

Figure 4. GSK3 and AKT intercation.(31)

Different scaffold proteins also interact with NFAT members to regulate their activity such as RNA non-coding repressor of NFAT (NRON) and caspase 3 which are negative regulators of NFAT activity.(30) (Figure 2)



I.2. CALCIUM SIGNALS

Ca^{2+} is a universal second messenger used by practically all cell types, whose extraordinary biological versatility is the consequence of the different patterns of spatial and temporal regulation.(38) A rise in cytosolic Ca^{2+} concentration is employed as a common signaling mechanism to control biological processes as diverse as exocytosis, contraction, cell growth and cell death.(32)

At least a three-dimensional signaling network with many cross connections among the transducers have been identified downstream to Ca^{2+} signaling: Ras/MAPK, Ca^{2+} /CaM/CaN and Ca^{2+} /CaM/calmodulin dependent kinase IV (CAMKIV) some of which probably enforce the signaling system by means of functional redundancy, while others may be linked to intricate circuit building capable to recognize and interpret subtle differences in the extracellular environment and together integrate the intrinsic states of the responding cell.(32)

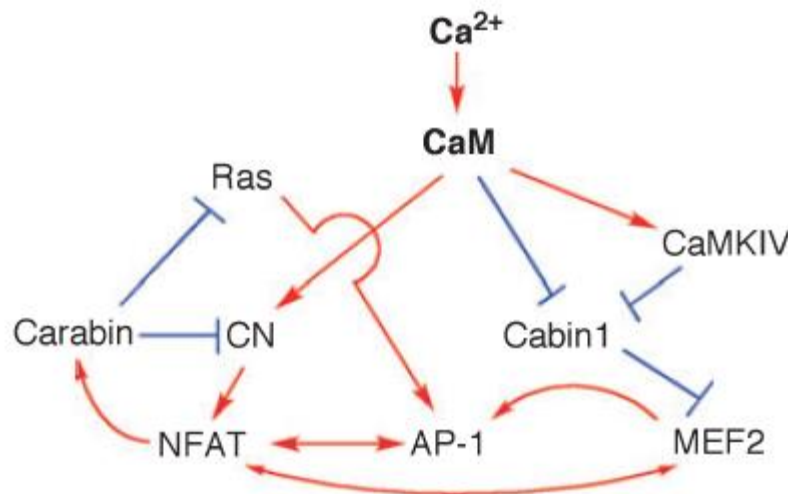

Figure 5. Calcium signal transducers network in T cells.(32)

Ca^{2+} signals are presented to cells as Ca^{2+} oscillations, with signaling information encoded in both the amplitude and frequency of the Ca^{2+} spikes.(39) Ca^{2+} oscillations in particular regulate numerous processes including gene expression, exocytosis, and excitation-contraction coupling; in general, oscillatory signals are biological regulators which through single message allow to encode different types of information through



variations in the frequency, amplitude, and spatial characteristics of the signal, thereby enhancing the specificity and efficiency of Ca^{2+} regulated processes.(38)(40)

Ca^{2+} influx into the cytosol occurs after antigen binding to T cell receptor (TCR), B cell receptor (BCR), tyrosine kinases receptor (RTK) or chemokine receptor.(41) They all activate PLC- γ pathway, opening IP3 receptor, allowing Ca^{2+} efflux from ER Ca^{2+} stores.(43) Only chemokine receptors couple to heterotrimeric G proteins and activate phospholipase C- β (PLC- β)(34). In T cells Ca^{2+} reservoirs in lymphocytes are small, and the Ca^{2+} ER contribution to overall cytoplasmic Ca^{2+} concentrations increase is limited.(43)

Ca^{2+} oscillations enhance CaN-mediated transcriptional regulation and Ca^{2+} oscillatory frequency is a critical determinant of calcineurin-dependent outcomes. A single signal of calcium wave is capable to launch different responses in the same target molecule depending on its subcellular location.(38) During physiological conditions Ca^{2+} oscillation is regulated by a balance between cytoplasmic and ER Ca^{2+} concentrations. $[\text{Ca}^{2+}]_i$ in the microenvironments near the calcium release-activated calcium channels (CRAC) are more important for NFAT nuclear translocation than a global increase of Ca^{2+} , highlighting the importance of local Ca^{2+} concentrations in T cells. Ca^{2+} may influence the stability of the immunological synapse by suppressing T cell motility indirectly.(40) Moreover, abnormal Ca^{2+} signals result in several immunodeficiency and autoimmune disorders.(41)

Ultimately gene expression pattern is set by the strength and duration of the Ca^{2+} signal provided by the TCR and SOCE/CRAC channels. In particular, intracellular Ca^{2+} decrease promotes NFAT rephosphorylation and export from the nucleus; explaining why NFAT gene transcription requires sustained elevation of $[\text{Ca}^{2+}]_i$.

In addition, Ca^{2+} requirements may differ between cell types besides the demand in resting cells and in storage compartments; in the immune system, SOCE flux through CRAC channels constitutes the principal input pathway for proliferation and activation process. (33)(34)



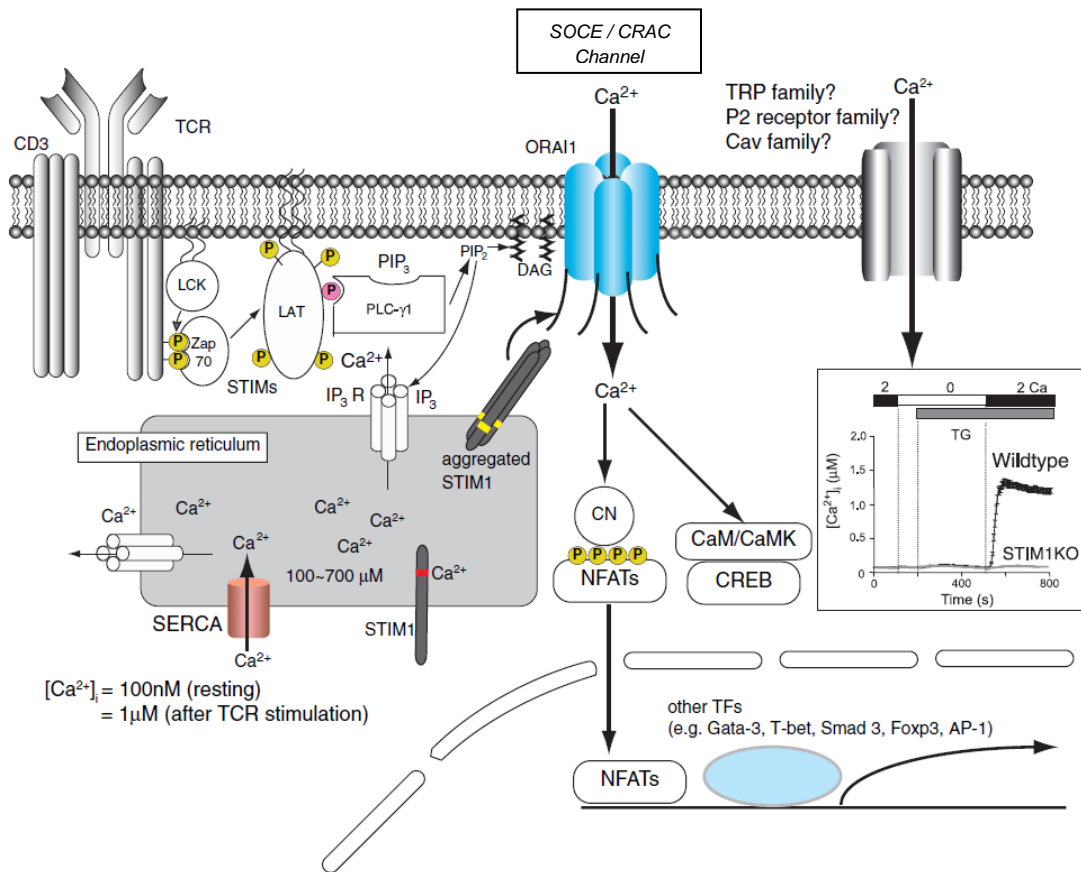

Figure 6. Representation of store operated calcium entry in T cells. (33)

In T cells, STIM1 and Orai1 are both recruited to the immunological synapse colocalizing with TCR, costimulatory molecules and tyrosine-phosphorylated molecules. STIM1 and Orai1 form a cap that may serve as a store for preassembled Ca^{2+} channel components which are feasible to be delivered to newly immunological synapses. IP3R1 also colocalizes with TCR after stimulation, and its phosphorylation at tyrosine 353 seems to increase CRAC channel sensitivity to IP3 activation and decrease its sensitivity to Ca^{2+} inactivation towards elevated Ca^{2+} levels. This colocalization process argue for Ca^{2+} influx availability at the synapse interaction site, thus facilitating long-term activation of antigen-stimulated T cells.(33)

Stromal interaction molecules STIM1 and STIM2 recognize the Ca^{2+} depletion in the ER via their paired N-terminal EF hands in the lumen. Once Ca^{2+} dissociates from the EF hands, STIM transmembrane type I proteins aggregate into small clusters in the ER membrane and STIM1 binds to the N- or C-terminus of tetrameric Orai1 to activate CRAC channel. STIM1 and STIM2 are functional ER Ca^{2+} sensors capable of SOCE regulation through CRAC channels in activated (store depleted) cells. SOCE opening



ensures prolonged increases in intracellular calcium concentration $[Ca^{2+}]_i$ and facilitates cell transcriptional reprogramming.(34) STIM1 triggers SOCE during the initial phase of the response, because STIM2 is not as effective to sense initial Ca^{2+} depletion. However, STIM2 operates in resting cells (Ca^{2+} replete stores) controlling basal Ca^{2+} influx and during the final stages when ER is being refilled. At these late stages, STIM1 is inactivated by Ca^{2+} rebinding, whereas STIM2 remains active due to its Ca^{2+} lower affinity.

Dependent and independent Ca^{2+} signals are required during the activation of naïve T cells. Ca^{2+} dependent transcriptional responses influence cytokine gene expression patterns of lymphocyte effector functions, anergy regulation, naïve T cells differentiation into Th1 or Th2 cells and the development of immature T cells.(41) Some of the cascades dependent on calcium influx for activation comprise: CaN/NFAT, CaN/CaMK/MEF2 (myocyte enhancer factor 2A), CaMK/CREB (cyclic AMP-responsive element-binding protein), NFkB and AP1.(34)(33)(41)

Strength, Duration and Amplitude of Ca^{2+} signals

TCR signaling strength also influences naïve T cells destiny, because strong TCR stimulus triggers a robust Ca^{2+} signal with IL-2 production leading to Th1 cell differentiation, whereas weak signals bias toward a Th2 response.(41)

Short Ca^{2+} signals occur within minutes and are implicated in processes that not involve gene transcription such as acute secretion; however sustained Ca^{2+} signals are required during T and B cell activation and differentiation and unresponsive state, due to several sequential rounds of gene transcription. (33)(34)

Some cellular activities might better respond to Ca^{2+} microdomains than to global oscillations in $[Ca^{2+}]_i$. These local Ca^{2+} signals can activate a gamut of cellular processes, varying enormously in both distance from the Ca^{2+} microdomain and the time-course of development as is the case of gene expression, which can occur hours after a brief burst of Ca^{2+} entry than only lasts just a few seconds.(39)



After TCR engagement during T cell proliferation and cytokine production, at least 10h of sustained increase of $[Ca^{2+}]_i$ is required for IP3 pathway.(34) APC and $CD4^+$ T cells interaction exiges a sustained increase of $[Ca^{2+}]_i$ of several hours in order to induce changes in gene expression; whereas cytotoxic T lymphocytes (CTL) mediated cytotoxicity (sinapse formation, release of lytic granules and first signs of cell death), occurs within the first 5 minutes of target cell recognition.(41)

Transient high Ca^{2+} spikes call up sustained activation of C-JUN N-terminal kinase (JNK) and NF- κ B, but not NFAT, whereas prolonged low increases in $[Ca^{2+}]_i$, are not enough to activate JNK or NF- κ B, but adequate for NFAT activation.(38)



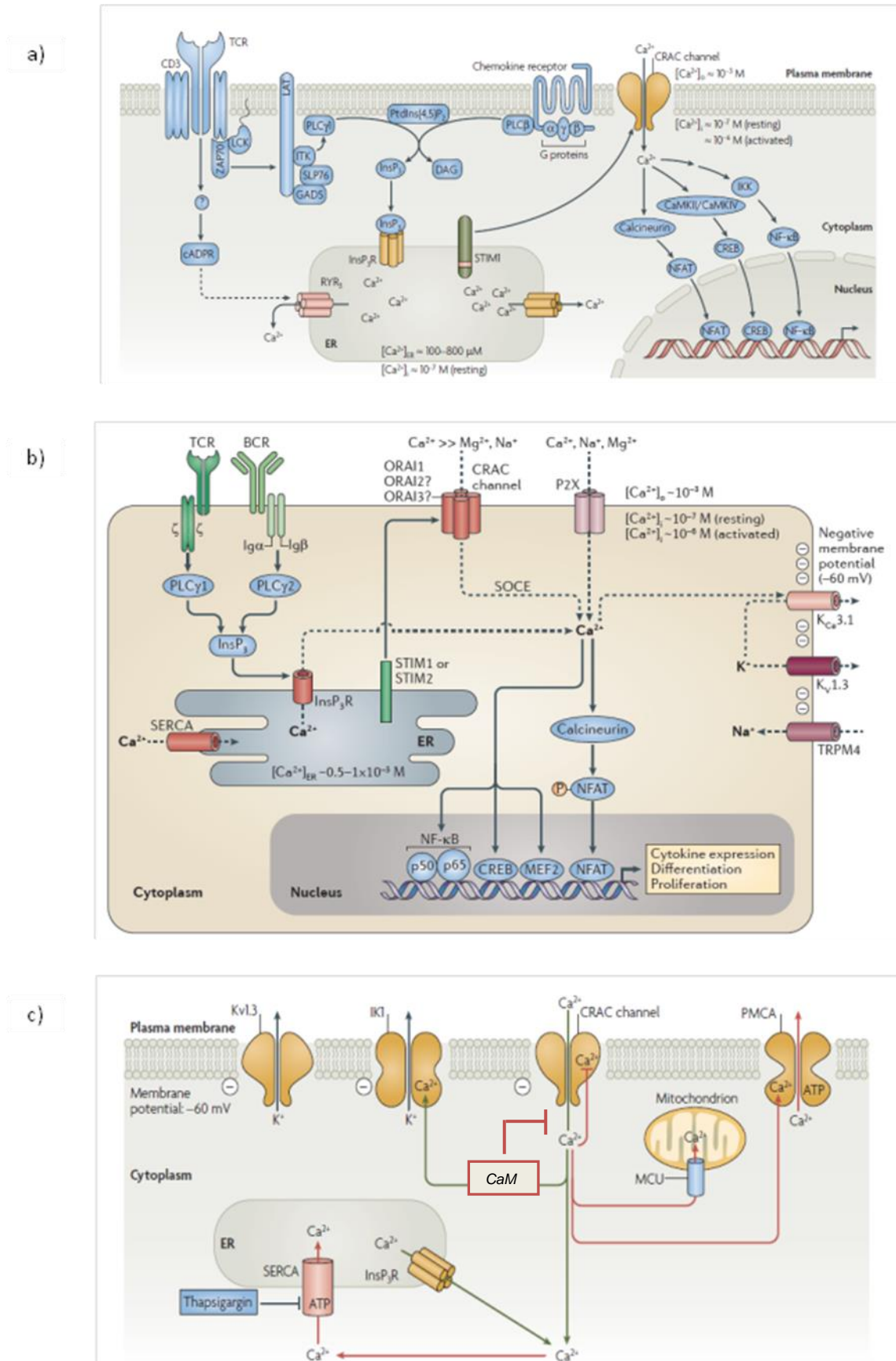

Figure 7. Calcium signaling and ion channel regulation in T lymphocytes. (40)(42) Pathways upregulating and downregulating intracellular Ca^{2+} levels are drawn in green and red, respectively.



Ca^{2+} oscillations could be the result of fluctuations in membrane potential, (repetitive opening and closing of voltage-gated Ca^{2+} channels) or more frequently of the activation of cell surface receptors capable to upregulate IP3 levels.(39)

As it has been mentioned amplitude and pattern (oscillation frequency, sustained levels, and microdomains) of Ca^{2+} signaling influence diverse downstream signaling pathways. In T cells Ca^{2+} entry via CRAC channels occurs at specific locations such as the site of ORAI1 and STIM1 clustering. [(Figure 8a)] Besides ATP P2X receptors, non-selective Ca^{2+} channels are activated by extracellular ATP.(Figure 8b) Figure 8c illustrates pathways upregulating and downregulating intracellular Ca^{2+} levels. (42)

In lymphocytes Ca^{2+} influx depends on the gradient between the extracellular ($\sim 100 \mu M$) and the intracellular ($\sim 0.1 \mu M$) Ca^{2+} concentration and the gradient established by two K^+ channels ($K_V1.3$ and $K_{Ca}3.1$) and the Na^+ permeable channel transient receptor potential cation channel M4(TRPM4). These two types of K^+ channels maintain the negative membrane potential (approximately -60 to -70 mV) required for Ca^{2+} influx through CRAC channels. Cell depolarization reduces the driving force for Ca^{2+} entry, which is balanced by the opening of $K_V1.3$ channels. Moreover IK1 (intermediate conductance calcium-activated potassium channel protein 1) channels open in response to Ca^{2+} influx and to increase intracellular Ca^{2+} concentration. Several mechanisms end or reduce the rise in $[Ca^{2+}]_i$ capturing Ca^{2+} from the cytoplasm and driving it into the ER and other intracellular Ca^{2+} stores, forcing it out from the cytoplasm by means of calcium⁺-ATPase pumps, or by protein hijacking.(34) Two types of ATP-dependent Ca^{2+} pumps are involved: sarco/endoplasmic reticulum Ca^{2+} ATPase (SERCA) in ER and the plasma membrane Ca^{2+} -ATPase (PMCA); this latter critical for dampening early peak of Ca^{2+} influx. In addition, mitochondria translocation into the immunological synapse benefits local Ca^{2+} entry and inhibits the negative feedback mechanism via PMCA.(40) Mitochondria sequester Ca^{2+} from the cell by two means: in the cytoplasm through a mitochondrial Ca^{2+} uniporter (MCU) and in the plasma membrane due to its proximity to CRAC channels withdrawing local Ca^{2+} and restraining CRAC channels inhibition feedback.(38) CaM was also identified as a negative regulator of CRAC channels, but at elevated $[Ca^{2+}]_i$ binds the N terminus of ORAI1 inducing fast Ca^{2+} dependent inactivation of the channel.(40)



I.3. CALMODULIN: A VERSATILE Calcium SENSOR

CaM is the common sensor for intracellular Ca^{2+} (calcium channels) allowing cells to decode Ca^{2+} oscillation signals from the cytoplasm to the nucleus. Ubiquitous CaM binds up to 4 calcium ions, one on each its EF hand motif.

CaM could be either cytosolic or membrane-bound, the latter often involving a CaM-binding motif (IQ motif), which consensus sequence "IQXXRGXXX" is found in many calmodulin-binding proteins, including voltage-gated Ca^{2+} channels. The on/off rate for Ca^{2+} binding to CaM are ~70-fold and ~170-fold faster in the amino-terminal than that in the carboxy-terminal domain, suggesting that both regions may respond differently to distinct temporal patterns of Ca^{2+} signaling, which is in line to CaM intra-molecular location of Ca^{2+} -binding sites.(43) The regulation of the amino-terminal domain requires a sustained rise in $[Ca^{2+}]_i$ provided by a global signal rather than by transient local Ca^{2+} signals, a characteristic of brief channel openings. By contrast, the carboxy-terminal lobe responds to transient local Ca^{2+} entry through P/Q-type Ca^{2+} channels.

In resting T cells calcium concentration in the cytoplasm is low, and Ca^{2+} /CaM binding sites are partially occupied, but after TCR signaling Ca^{2+} influx to the cytosol fulfills the 4 calcium-binding sites in CaM, undergoing to a significant conformational change, binding to and activating several target proteins to transmit signal downstream to the nucleus, to enable transcriptional activation of genes.(32)

CaM also couples CRAC channel during NFAT activation pathway. CaM colocalizes with the CRAC channel for sensing Ca^{2+} and when occupied by Ca^{2+} activates CaN. ORAI1 the pore forming subunit of the CRAC channel binds CaM at the amino-terminal end, enabling Ca^{2+} microdomains closely to CRAC channels to activate CaN. CaN bound to CaM directs NFAT translocation to the nucleus and colocalizes too. CRAC channel expression level will significantly impact on the rate and extent of NFAT movement.(44)

Ca^{2+} /CaM especially act as a highly localized signal, but fast, long-range signaling may require active transporting of CaM to other parts of the cell. CaN activity is proportional to CaM concentration and the limitant factor for its activation is Ca^{2+} /CaM availability.



In the cytosol and at the plasma membrane, Ca^{2+} oscillations upregulate calcineurin activity, but at organelle surface within the cell (ER and mitochondria), CaM is less available for CaN activation so CaN activity in the surrounding organelles could be more exposed and susceptible of being suppressed by other proteins. However when CaM concentration threshold is attainable this inhibition does not take place. In this sense Ca^{2+} /CaM spatial compartmentalization is plays an important role in CaN signaling regulation.(38) CaN is differently activated within the cell, and subcellular components are adjusted during the regulation of the diverse CaN targets. As calcineurin activation differs in the ER and cytosol, CaN may remain activated for longer periods in the cytosol than at the ER, making cytosolic calcineurin less susceptible to PKA activity; therefore oscillatory signals can spatially restrict enzyme activity towards local ER and mitochondrial targets.



I.4. CALCINEURIN

Calcineurin (PP2B) is a serine-threonine phosphatase activated by Ca^{2+} /CaM binding, capable to transmit signals to the nucleus via dephosphorylation and subsequent translocation of NFAT family of transcription factors. It is ubiquitously expressed and one of the rate-limiting signal transducers during T cell activation. The protein is composed by two principal domains: the catalytic (CaNA, with phosphatase activity) and the regulatory (CaNB, which resembles CaM) both of which exist in multiple isoforms.

Interestingly, CaN makes part of the group of the intrinsically disordered proteins (IDP), those which are biologically active but without stable secondary and or tertiary structure, a feature that challenges the classical paradigm "sequence \rightarrow structure \rightarrow function". This structural plasticity may represent a major functional advantage which impact on its folding mechanisms and function. Contiguous to these disordered (flexible) regions locate the sites for protein interaction. Furthermore the same flexible region of these proteins can fold distinctly according to their partners, and different amino acid sequences can take advantage of this flexibility to fold onto a common binding site on the same protein. In addition, this particular structure has also been implicated in loci alternative splicing and in enzyme posttranslational modifications such as phosphorylation, methylation, or acetylation. The rich binding sites localized in these flexible regions can be controled or removed by posttranslational modification and by alternative splicing, a phenomena critical for signaling diversity. Disordered regions characterizes for not binding to any partner, however they retain important functions such as providing flexible linkers between structured domains or tails which serve to the regulation of structured domains. CaN crystal structure has revealed four disordered regions, whose lengths are 95, 35, 13, and 4 residues and by which exerts signaling and regulation. (45) Calcineurin B regulatory subunit is a calmodulin homolog that also has 4 calcium binding sites.(46)



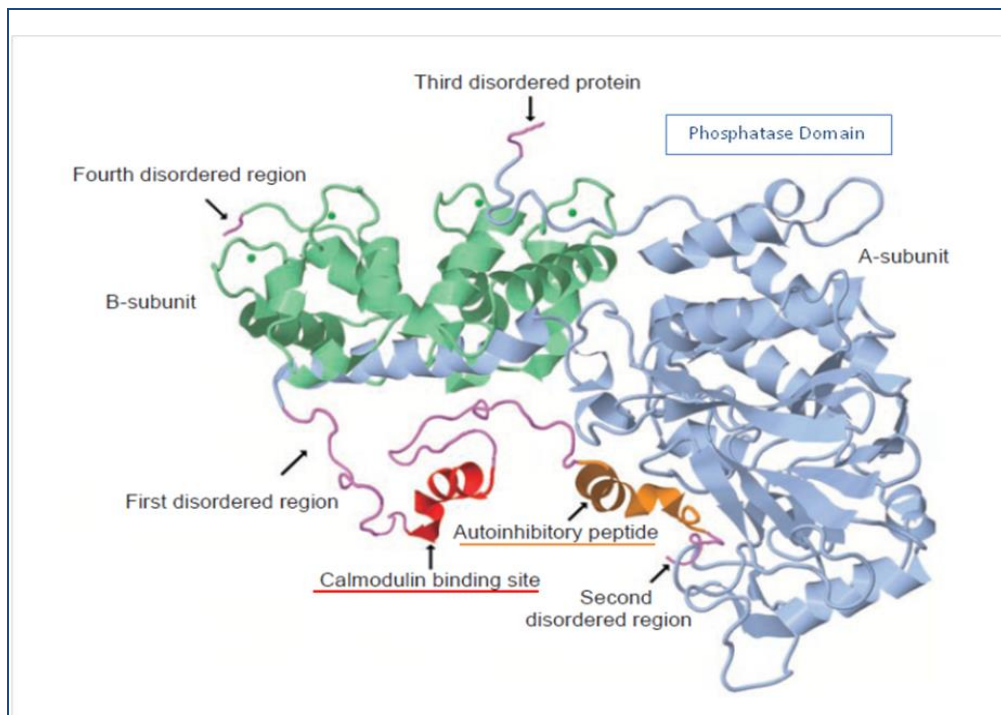

Figure 8. Ribbon representation of Calcineurin subunits and critical binding sites.(45)

Biochemical and biophysical studies have shown that the 4 calcium sites in CaNB are communicated within each other and together they articulate a conformational change on this lobe, which is pivotal for substrate recognition.(47) Low affinity sites in CaNB subunit serve as Ca^{2+} sensors, which regulate the occupancy of the other two sites upon an increase of calcium levels. (46)



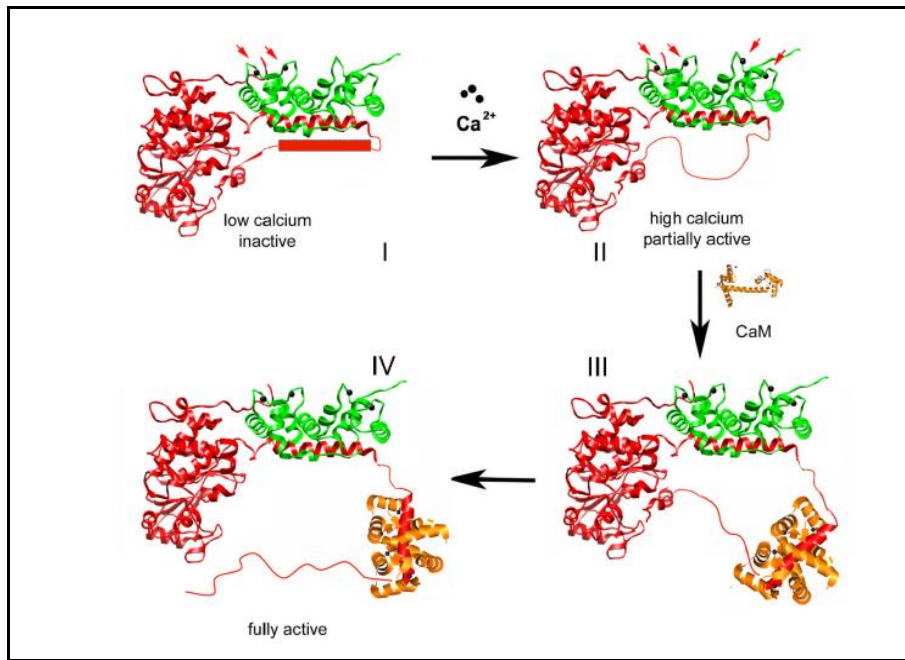

Figure 9. Sequential concerted conformational changes during Calcineurin activation.(37)

CaNA can be divided into 4 distinct domains: the catalytic at the very N-terminus; the B subunit-binding; the CaM- binding and the C-terminal autoinhibitory peptide (AIP) domain, which has 19-residue of length and lies between the first and second disordered regions. On the contrary, CaNB is composed of 4 tandem EF-hands (34), a motif extensively employed for Ca^{2+} binding; Ca^{2+} binding sites experiment conformational changes to expose the desired surface for target interaction(46).

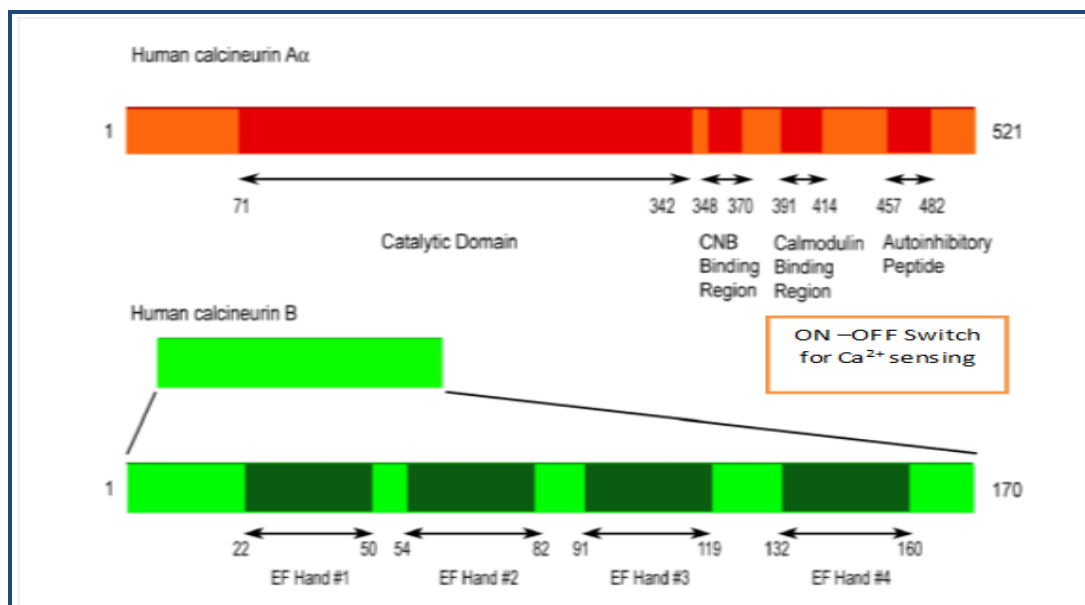

Figure 10. Calcineurin structure diagram, showing catalytic (A) and regulatory (B) subunits composition.(37)



In resting cells, only the 2 of the 4 Ca^{2+} with moderate-affinity binding sites of CaNB are occupied keeping CaN inactive because the AIP still lays over the CaNA active site. Nevertheless, when physiological signaling increases $[\text{Ca}^{2+}]_i$ the other two low-affinity sites become fully or partially occupied; those sites and their associated binding surfaces in the N-terminal half of CaNB suffer significant conformational changes, triggering further conformational change in CaNA which results in the exposure of the CaM-binding region.(46) CaNB-CaM-binding site locates within the first disordered region which probably adopts a helical conformation upon CaM binding, and due to its vicinity to the AIP domain causes a further conformational change displacing the AIP from its site (acts as a pseudosubstrate), turning on CaN enzymatic activity.(45)(46) Upon binding CaM encloses CaN localizing its binding site within a region of disorder giving access to CaN whenever is required. Consequently, this linking region becomes essential to CaN regulation by Ca^{2+} /CaM.(32)(34)(37)(45)(47)

In fact CaM-binding domain and the C-terminal AIP together form an intramolecular switch for Ca^{2+} -sensing, whereas the principal CaN/NFAT interaction region involved in downstream signaling is a main conserved motif in the N-terminal regulatory domain of NFAT.(48)

In humans, the catalytic subunit has 3 identified isoforms: α , β and γ ; while 2 in the regulatory subunit: CaNB1 and CaNB2; however, in lymphocytes only α , β and CaNB1 isoforms are the most relevant.(32)

Despite CaNA α sustains more than 70-80% of CaN activity in peripheral T cells, its disruption does not lead to significant changes in overall T cell function. Nevertheless, isoform β (which accounts for 20–30% of the calcineurin activity) stands up as the major functional variant of CaNA in both T and B cells, since more severe T cell development and functional defects are seen from knockout experiments during thymocyte activation and negative selection(48) and since absence or mutations of β isoforms downregulate cell proliferation and IL-2 production in response to TCR stimulus; however both isoforms are important to TCR signaling.(32)



CaN is directed to NFAT interaction by the recognition of 2 conserved docking sequences: PxlxIT and LxVP near the N terminus and C terminus of the highly conserved NFAT regulatory region respectively. In T cells if these docking sites are mutated (34), CaN/NFAT signaling could be interrupted, even if PxlxIT-binding site does not belong to calcineurin catalytic site. PxlxIT recognition sequence interacts with the β -strand 14 of CaNA through a parallel alignment in a β -sheet conformation.(48)

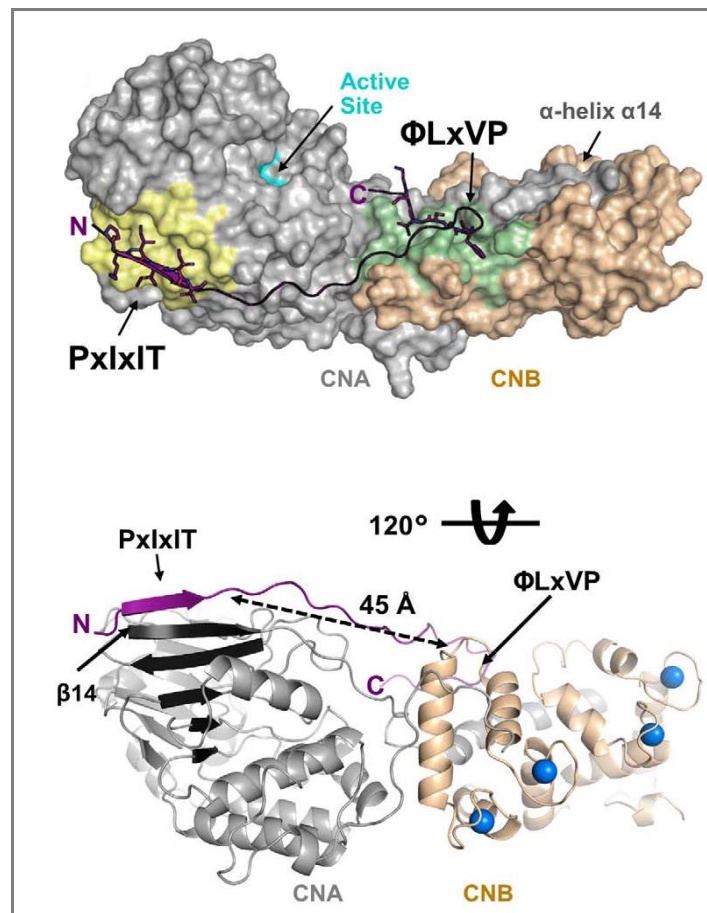

Figure 11. Model of both calcineurin docking sequences PxlxIT and LxVP in NFAT. (49)



I.5. IMMUNOPHILINS

Immunophilins are peptidyl–prolyl cis–trans isomerases (PPIs) which include cyclophilins (CyPs), TAC binding proteins (FKBPs) and parvulins. Their physiological role is to stabilize the cis-trans transition state and accelerate isomerization, very important during protein folding, and the assembly of multidomain proteins.(50) In addition to protein folding, FKBP12 are involved in several biochemical processes, including receptor signalling, protein trafficking and transcription.(51) Both CyPs and FKBP12 express several isoforms.(51)

Immunophilins are more abundant in the nervous system than in immune tissues, suggesting their biological significance in neurons.(51)

CsA and TAC form a ternary complex with immunophilins: cyclophilin A (CyPA) and FKBP12 respectively to bind to CaN and to exert inhibitory effects. The two PPIs have different dissociation constants (Kd) with their pharmacological ligands: 2nM for CyPA-CsA and 0.4nM for FKBP12-TAC.(51)

Among the different FKBP12s identified in cellular compartments (FKBP12, FKBP13, FKBP25 and FKBP59), only the FKBP12:TAC complex inhibits CaN activity.(32)(46)

CyPA and FKBP12 interact with calcineurin even in the absence of exogenous ligands (CNIs).(32)(46) The CyPA:CaNA complex is more robust and is less enhanced by CsA binding than the FKBP12:CaNA complex is by TAC.(46) The binding sites for CNIs are not occupied in the independent pre-formed complexes, but once they are bound, they intensify calcineurin inhibition.(46) CaNB and FKBP12 compete for CaNA binding. The different structures of the FKBP12:CaNA and FKBP12:TAC:CaN complexes suggest the involvement of different FKBP12 residues.

The two structurally distinct [immunophilin–drug] complexes compete for overlapping binding sites on calcineurin, and their association with CaN is mutually exclusive. In fact, both [PPIs-calcineurin] complexes are disrupted by the action of CNIs.(46) Each CNIs-dependent complex binds to the composite surface formed by the B subunit-binding domain (in the form of an amphipathic peptide) of CaNA and the bound regulatory subunit CaNB. These interactions outside of the catalytic and AIP domains,



create an allosteric impairment that impedes larger substrates such as NFAT to approach to the active site of CaN.(32)

Two models have been postulated to explain how immunophilins modulate calcineurin activity. One possibility relies on immunophilins action during calcineurin assembly by which FKBP12 may antagonize the binding of CaNB regulatory subunit to CaNA catalytic domain, inhibiting the enzyme. Aligned to this, Cardenas et al. found that [FKBP12:CaNA] complex increases 10-fold in vivo in the absence of CaNB. In contrast, CyPA could promote the assembly of the two subunits; taken all together, calcineurin activity might be controlled by the assembly rate of both subunits and by this means immunophilins would be able to inhibit or catalyze calcineurin assembly respectively.(46) The second postulate argues in favour of immunophilins calcineurin function regulation through dynamic protein interactions, with a direct participation in signal transduction.(46) Anyway, both alternatives are not mutually exclusive.

PPIs could also form ligand-independent complexes with other proteins. Under physiological conditions, FKBP12 binds to ryanodine receptors (RyRs), which is one of the major Ca^{2+} releasing channels in the sarcoplasmic reticulum (SR). FKBP12 stabilizes the RyR channel, favoring its opening.(46)(51)(52)(53)(54)

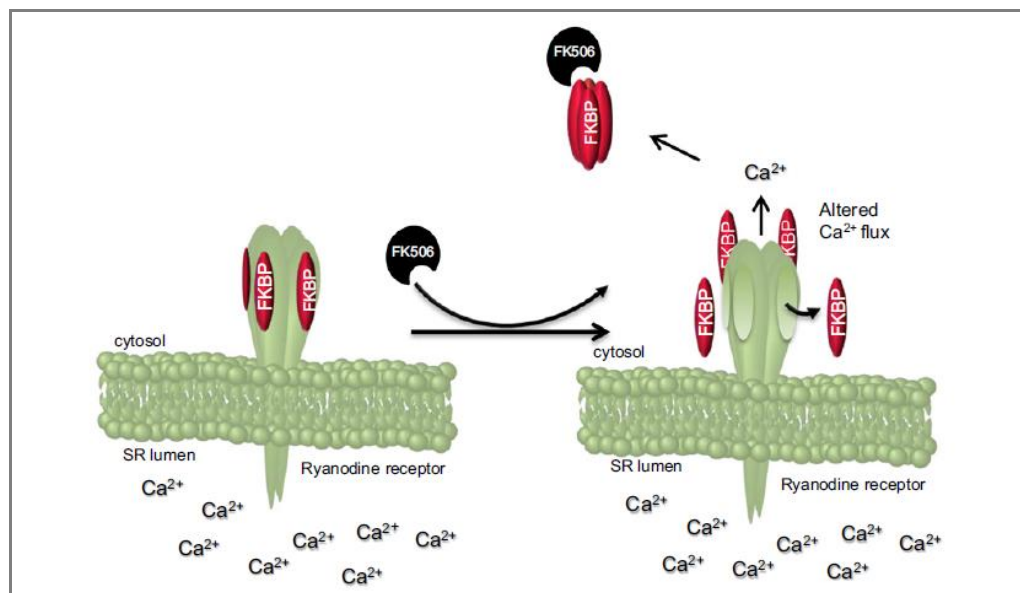

Figure 12. FKBP12 association with ryanodine receptors in Sarcoplasmic Reticulum's membrane and the mechanism of action of tacrolimus (FK506).(52)



Four ryanodine receptor subunits in a single tetrameric channel structure are associated to FKBP12 in a ratio 1:1. This interaction is susceptible to disruption by TAC, removing the protein from the channel, and consequently altering Ca^{2+} flux through the channel.(52)

FKBP12 also acts as a natural ligand for TGF β which regulates a wide range of biological processes.(51)

Human cyclophilins consist of 16 family members that are structurally distinct in their subcellular localization and binding affinity to CsA. From this family, 7 are the most important: CyPA, B, C, D, E, 40 and NK. Cyclophilins are engaged in a diversity spectra of cellular functions, such as cell growth, proliferation and motility.(53)

CyPA is the most abundant member of the cyclophilin family in human tissues and is the principal target of CsA.(53) In humans CyPA is allocated in the cytoplasm of all tissues, whereas the others belong to the ER (CyPB and C), the mitochondria, or the nucleus (CyPE).(50) Among the different cellular functions of CyPA, it is highlighted in protein folding, trafficking, assembly, immune-modulation, and cell signaling.

Even though CsA is able to inhibit both CyPA and CypB, it is more selective for the former while the latter increases cellular sensitivity to CsA.

Many inflammatory diseases, like severe sepsis, rheumatoid arthritis, and vascular smooth muscle cell disease relate to high levels of extracellular cyclophilins.(55) This augmented expression of CyPA correlates with poor prognosis of the inflammatory pathological condition. Under inflammatory conditions, CyPA is secreted from cells and plays as an autocrine and paracrine factor exacerbating the oxidative stress and inflammation status.(56) In the extracellular microdomain CyPA has shown a dual effect, by promoting cell proliferation and migration at low doses, but cytotoxic effects at higher doses. Furthermore, CyPA acts a non-receptor tyrosine kinase is involved in the regulation of T cell-specific IL-2 tyrosine kinase (Itk); Itk is engaged to thymocytes' maturation and intracellular signaling events leading to T cell activation. If the interaction between Itk and CyPA is disabled, the result is an increase in the production of Th2 cytokines'levels(56) which are responsible for antibody production, eosinophil



activation, and the inhibition of several macrophage functions impacting on immune response.

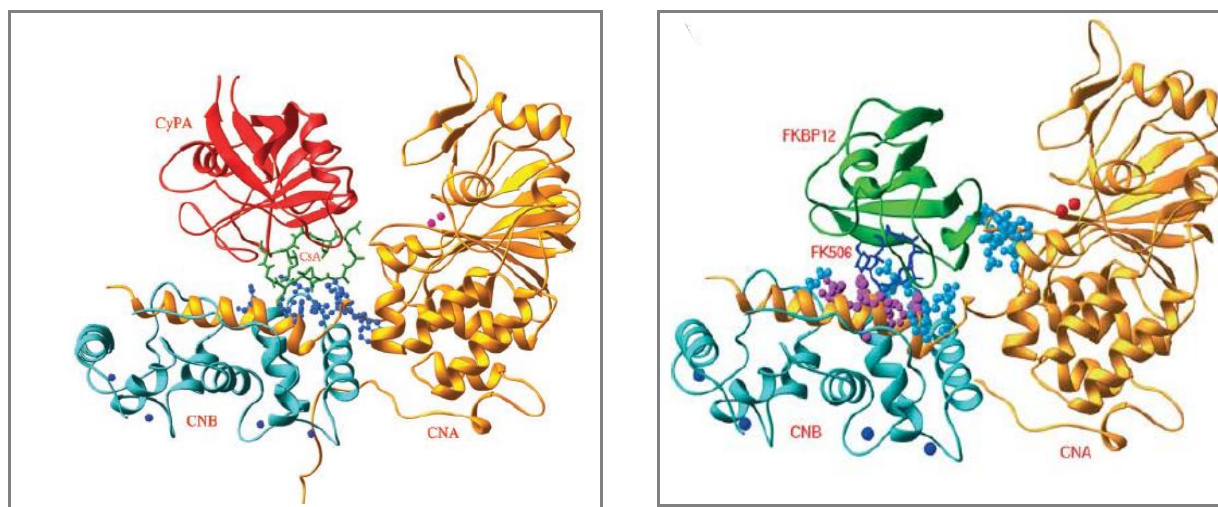

Figure 13. Ribbon representation of the complex [CyPA-CsA-CaN] (57) and [FKBP12-TAC-CaN] (47).

CaNA, gold; CaNB, cyan; CsA, green; CyPA, red; Zn^{2+} and Fe^{3+} , pink balls; Ca^{2+} blue balls. The residues from calcineurin involved in binding of PPIA-CNIs are shown as blue balls.

Protein secondary and quaternary molecular structure are affected during CaN/NFAT recognition, entailing hydrogen bonds, van der Waal forces, protein-protein and hydrophobic interactions.(47) A comparative study on the CaN residues involved in CyPA:CsA and FKBP12:TAC binding showed that 20 out of a total 25 CaNA residues participate in hydrophilic or hydrophobic interactions with both immunophilin:immunosuppressant complexes. Among the 20 commons, Trp352 and Phe356 of CaNA and Met118 and Val119 of CaNB emerge to be the main residues for their multiple hydrophobic contacts with residues 2–6 of CsA or a group of atoms of TAC.(47)

The 5 exclusive residues by which CyPA:CsA complex intercates with CaNA subunit are Arg-122, Tyr-315, Trp-342, and Thr-362 and Lys-164 on CaNB, whereas for FKBP:TAC complex on CaNA are Asp-313, Met-347, and Thr-351 and on CaNB Asn-121 and Gln-127. Despite of the similarities of CaN binding residues both immunophilin–drug complexes recognition patterns are quite different regarding how they establish hydrogen bonds and van der Waals interaction with such residues.



Curiously, of the 9 hydrogen bonds set up between CyPA:CsA:CaN, only 4 are shared by FKBP:TAC, distinguishing the poorer degree of conservation of hydrogen bonds and exhibiting high flexibility for diverse protein binding. Even more, disruption in van der Waals contacts between residues of the calcineurin catalytic subunit and immunophilin leads to distinct T lymphocytes CNIs resistance pattern. If Trp-352 which is a critical residue of CaNA subunit and commonly recognized by both CNIs is removed, this will cause a loss of the binding energy between FKBP:TAC and CaN translated as a selective resistance to the drug, due to is the only aminoacid that forms a hydrogen bond with TAC; however, the same removal is compensated in CsA because it establishes another hydrogen bond with Tyr-341. Similarly mutagenesis on CaNB residues alter calcineurin drug-immunophilin binding affinity. The loop Asn-121 and Gln-127 forms 3 hydrogen bonds and several van der Waals interactions with TAC and FKBP, then an insertion between those residues results in significative distortion of FKBP binding; nevertheless the same effect does not occur with CsA which has practically no interaction with the loop.(57)

Differences in drug-immunophilin interactions seem to lie in the tertiary structure of the complex. The superimposing of CyPA:CsA or FKBP12:TAC to calcineurin does not change the overall conformation of the enzyme, but CaNB binding helical domain (BBH) displaces towards immunophilins after the binding of the immunophilin–drug complexes.(47) Moreover, during this structural interaction the AIP domain of CaN overlaps with CyPA and FKBP12, suggesting that the binding of the immunophilin–drug complexes impacts on the conformation of the autoinhibitory motif.(47)



II. THE NFAT FAMILY

In immune cells NFAT proteins are implicated in several processes including T cell activation, differentiation of Thelper (Th) cells and effector function (cytokine production), as well as in self tolerance.(48)

NFAT functional versatility is revealed by its regulation mechanism and its capacity to integrate Ca^{2+} signaling downstream and with other pathways.(31)

The NFAT family is composed of 5 isoforms, with only 4 regulated by calcium signaling: NFAT1 (NFATp or NFATc2), NFAT2 (NFATc or NFATc1), NFAT3 (NFATc4) and NFAT4 (NFATx or NFATc3). The fifth one, NFAT5, recognized as the tonicity-responsive enhancer-binding protein (TonEBP; also known as OREBP) is present in almost all cells and obeys to osmotic stress stimuli. Particularly in lymphocytes, NFAT5 controls the osmotic stress-induced expression of several cytokines, including tumour-necrosis factor (TNF) and lymphotoxin- β . (31) NFAT1, 2 and 4 are the most related to T cells, whereas NFAT3 is not expressed in the immune system. NFAT1 is characteristic of peripheral T cells and in $CD4^+$ and $CD8^+$ single positive (SP) thymocytes; furthermore in resting T cells NFAT1 is the foremost factor which is responsible for up to 90% of total NFAT/ DNA binding activity.(48) NFAT2 is found mainly in $CD4^-CD8^-$ double-negative (DN) and in activated peripheral T cells. (33) TCR stimulation also induces the expression of a short isoform of NFAT (NFAT2A α) which enhance T cell activation more than the other NFAT family members by bearing proliferation and protecting against cell death.(40). Finally NFAT4 is found in double positive (DP) thymocytes but less in the periphery.(33)

Each protein has two or more alternatively spliced forms, resulting in variations at the amino (N) and carboxyl (C) termini but with the core region conserved.

NFAT proteins conserved region consists of two tandem domains: a regulatory domain [NFAT-homology region (NHR)], and the REL-homology region (RHR), which binds DNA. The NHR is pretty conserved among NFAT proteins; it allocates the transactivation domain (TAD) and the docking sites for CaN and NFAT kinases interaction, necessary for protein–protein recognition during NFAT activation, and contains the serine residues which are dephosphorylated in activated T cells.(33)



However, RHR domain is the unifying characteristic of NFAT proteins, conferring them common DNA-binding sequence specificity(31) and contains the interaction sites for *FOS* and *JUN* genes to allow the formation of the synergistic NFAT:FOS:JUN:DNA quaternary complex.(31)

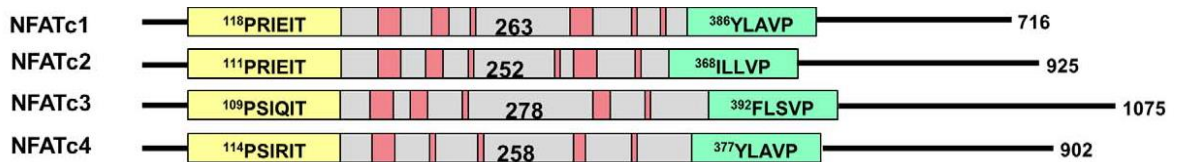
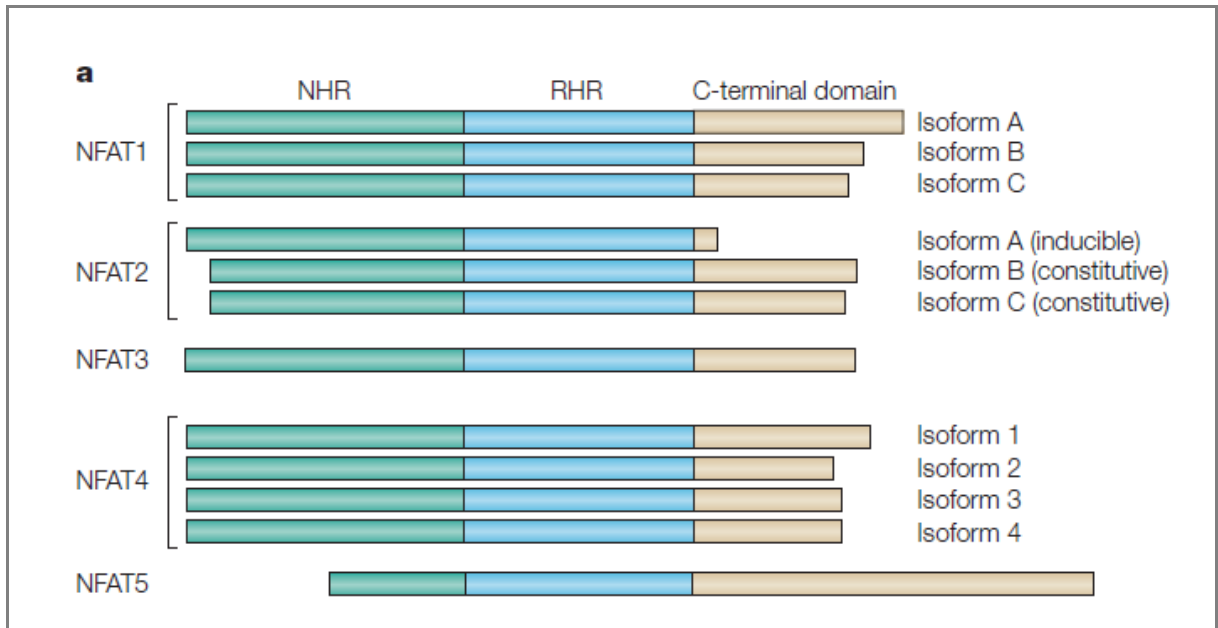

Figure 14. Schematic structure of NFAT family of transcription factors aligned by their REL-homology domain.(31)(49)

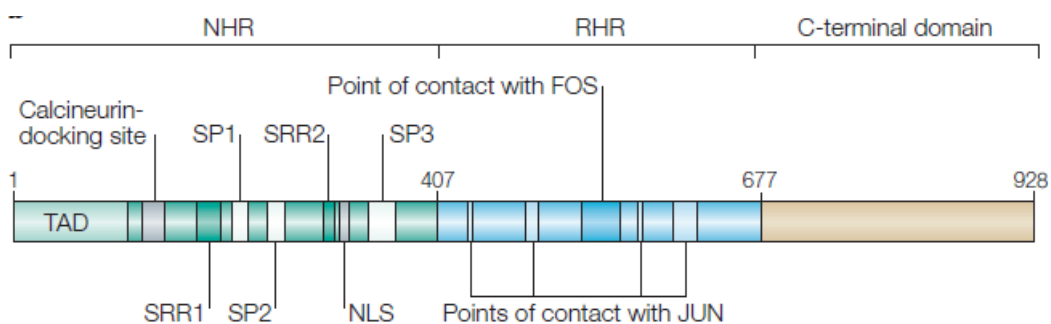

Figure 15. DNA binding motif structure.(31)



II.1. NFAT STRUCTURE AND ACTIVATION

Summarizing during T cell activation, TCR engagement triggers the calcium–calcineurin–NFAT pathway, by means of PLC- γ activation, which hydrolyses phosphatidylinositol-4,5-bisphosphate to produce IP3 and diacylglycerol. IP3 drives the release of calcium from intracellular stores, opening the CRAC channels in the plasma membrane, increasing and sustaining the intracellular concentration of calcium. Calcium is now recruited to calmodulin low affinity sites enabling the protein to bind to calcineurin. Once calcineurin is activated, it could dephosphorylate the entire pool of phosphoserines in the regulatory domain of NFAT of T or B cells within 1–2 min, due to a strong Ca^{2+} mobilization, leading to NFAT nuclear translocation.(34)

In the nucleus, NFAT proteins cooperate with multiple transcriptional partners preactivated in response to TCR and co-stimulatory signaling, such as AP1, forkhead box P-family proteins (FOXP2 and FOXP3, winged-helix 2 and 3) of transcription factors and proteins of the GATA family, to initiate and maintain specific transcriptional programmes depending on cell type and stimuli nature.(30)(31) After stimulus stop, NFAT kinases such as GSK3, CK1, and DYRK1A, mask NFAT nuclear localization sequence and NFAT is exported to the cytoplasm. In sum NFAT activation results from the balance of dephosphorylation and competing rephosphorylation processes.

II.1.1. NFAT Dephosphorylation/Activation

NFAT activation is initiated by dephosphorylation of the NFAT regulatory domain, at a conserved ~300-aminoacid region located N-terminal to the DNA-binding motif with the consensus sequence PxlxIT, where x denotes any amino acid (SPRIEIT). (31)(58) CaN docking site on NFAT differs from the calcineurin catalytic site.(31)

To dephosphorylate NFAT, CaN must first dock at a specific motif in the regulatory domain. In fact 2 docking sites have been recognized for calcineurin binding on NFAT regulatory region: the PxlxIT motif near the N terminus and an LxVP motif more near the C terminus.(37)

Proline kinase sites allocate in a conserved tandemly repeated motif termed serine/proline (SP) repeat which control NFAT nuclear localization and are



simultaneously kinase and calcineurin substrates. Serine-rich region (SRR) is another conserved motif, with a group of possible kinase sites.(27)

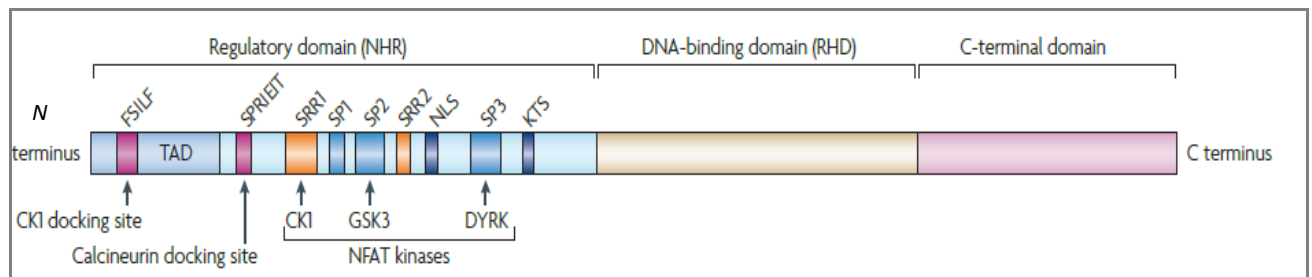
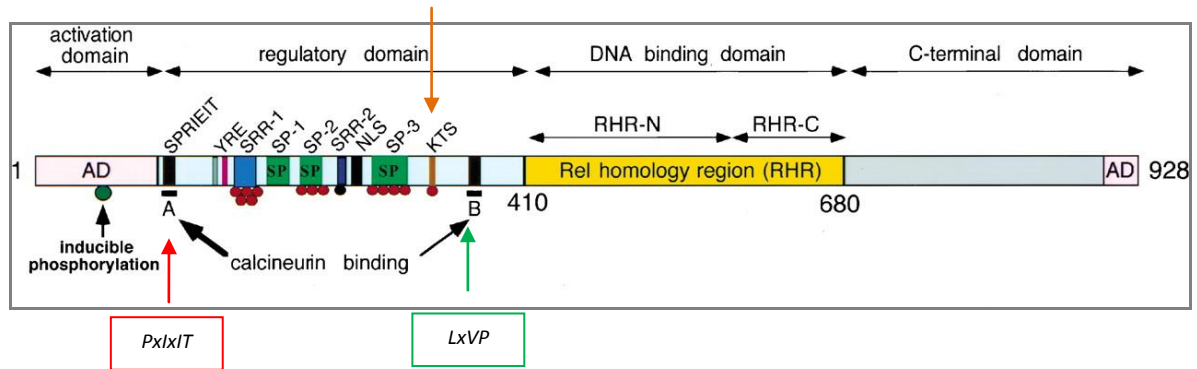

Figure 16. Diagram structure of phosphorylation sites on NFAT.(30)(59)

Phosphorylated residues are represented as filled circles. Conserved phosphoserines that suffer dephosphorylation upon activation are in red, non-conserved phosphoserines in gray, the conserved phosphoserine in N-terminal to the NLS in black; and the inducible phosphorylation site in the N-terminal transactivation domain in green.

The NHR holds an N-terminal TAD, the docking site for CK1, termed FSILF, multiple serine-rich motifs (SRR-1 serine rich region1, serine proline repeat motif 1 SP-1, SP-2, SRR-2, SP-3 and KTS, lysine-threonine-serine sequence) and a nuclear localization sequence. A short conserved region including the sequence YREPLCLSPASSGSS (YRE, yeast *apc1* response element) within the SRR1 has been shown to be involved in NFAT retention in the cytoplasm. Furthermore changes in Arg-164 residue or in serine residues subject to phosphorylation/dephosphorylation, induce NFAT partial nuclear translocation in resting cells.(60)



The phosphoserines targeted by calcineurin dephosphorylation are in the SRR1, SP2 and SP3 motifs. These serines are phosphorylated in the cytosol by maintenance kinases and in the nucleus by export kinases. GSK3 phosphorylates NFAT to maintain it in the cytosol.

Motif	Amino-acid sequence	Maintenance kinase	Export kinase
SRR1	SPASSGSSASFISD	CK1	CK1
SP2	SPRTSPIMSPRT	ND	GSK3
SP3	SPQRSRSPSPQPSP	ND	ND (GSK3 for NFAT2)

Figure 17. Serine rich and proline motifs and associated kinases.(31)

It has been postulated that CaN binding to the NFAT docking sequence intensify dephosphorylation efficiency at the multiple sites, facilitating subsequent dephosphorylations.(27) Dephosphorylation of the first residues may have a lower calcium requirement whereas the subsequent unmasking of the NLS may require stronger calcium stimulus.(58)(61)

II.1.1.1 Calcineurin docking

Additionally to PxlIT sequence, a second CaN-binding motif, named CaN binding region 2 (CNBR2), contains the «LxVP» near the C terminus after the third SP repeat of the highly conserved NFAT regulatory region. This motif contributes to calcineurin interaction facilitating NFAT2 and NFAT4 proteins dephosphorylation. Furthermore, LxVP motif is homologous to the endogenous calcineurin inhibitor calcipressin family (Csp/DSCR1/MCIP1).(31)(37)(48)

Contrary to PxlIT, LxVP sequence contains peptides for inhibiting CaN/NFAT interaction and calcineurin phosphatase activity. These peptides bind to a site localized near the calcineurin B-binding helix and the active site of calcineurin (see Figure 12).



The existence of these two distinct docking sites in NFAT may allow a dynamic movement of the substrate relative to CaN and allowing different responses.(32) Additionally, it was recognized an interaction between LxVP peptides and calcineurin regulator proteins (RCANs).(37)

CaN /NFAT crystal structure analysis revealed that PxlIT peptide makes contact to a second calcineurin A molecule, which might be implicated in the assembly of some larger calcineurin complexes.(37)

II.1.1.2. Calcineurin – NFAT interaction

Mass spectrometric analysis of NFAT1 bring to light at least 22 phosphorylation sites, 18 of which are located in the N-terminal regulatory domain, (62)(63) while any were found within the N-terminal transactivation domain (residues 1–98) or in the DNA binding domain (residues 399–680) while 3 were recognized within the C-terminal domain. (63) However, and inducible phosphorylation site was found in the TAD also involved in transcriptional activity.(63)

14 phosphorylated conserved phosphoserine residues in the NFAT regulatory domain keep NFAT in the cytoplasm in resting T cells.(34) CaN dephosphorylates up to 20 serine residues on the serine-rich region 1 (SRR1) and the serine proline repeat motifs (SP) of NFAT1.(62)(61) Dephosphorylation in response to calcineurin activation leads to conformational changes, exposing one or more of the NLS to the nuclear import machinery.(27) Fully phosphorylated NFAT is capable of entering the nucleus by a very slow calcineurin-independent import, but it still counts on NLS recognition.(60)

Until now it is not known if dephosphorylation process follows an orchestrated order, but mass spectrometry experiments have suggested that the SRR1 region (nearer to PxlIT docking site) is preferentially dephosphorylated at low calcineurin activity.(63) However, the most remarkable feature was the selectivity of the phosphorylation.(60) SRR-1 region is phosphorylated on only 5 of its 7 conserved serines, SRR-2 contains only a single phosphate, SP1 is not phosphorylated, and the second and third SP-repeat motifs (SP2 and SP3) are phosphorylated on 3 (of 4) and 4 (of 5) serines, respectively. Apparently SRR-1 region seems to regulate NFAT1 active conformation.



At low stimulus strengths SRR-1 region was more susceptible to dephosphorylation than the SPxx-repeat motifs. SRR-1 region dephosphorylation promotes further dephosphorylation of the SRR-1, SP-2, and SP-3 regions required for NFAT full activation.(60) At this state a NLS in the regulatory domain is exposed while the nuclear export sequence (NES) remains masked.(33)(60)

The phosphorylation status of the regulatory domain determines DNA-binding affinity, as well as the relative exposure of NLS and NES sequences.

In resting cells the conserved phosphoserines of the regulatory domain are all stoichiometrically phosphorylated; however the nonconserved phosphoserine residues could be partially phosphorylated. Only the phosphoserine at position 245, next to NLS site in the SRR-2 region does not require stimulation for being dephosphorylated.(60)

Intermediate dephosphorylation levels determine a series of transitional conformations on the path towards the fully active form.(60)

Beals et al. proposed a model for NFAT translocation in which CaN dephosphorylation unmask 2 NLS partially redundant: KRK at position 265-267 in the N terminal regulatory domain of NFAT, and KRKK at position 682-685 in C-terminal domain.

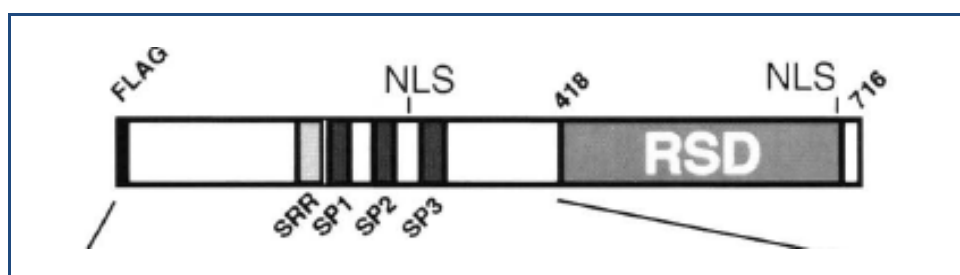

Figure 17. Localization of the two NLS in NFAT2.(27)

SRR-1 dephosphorylation partially exposes the NLS sequence and increases NFAT1 susceptibility to calcineurin dephosphorylation at the SP-repeat motifs. On the other hand, DNA binding affinity of NFAT proteins could be controlled by the phosphorylation status of the SP-repeat motifs.(63)

Focal mutations on those residues subjected to phosphorylation and calcineurin dephosphorylation, lead to constitutive partial nuclear localization of NFAT1 in resting



cells. NFAT full nuclear translocation requires additional dephosphorylation by calcineurin. When SRR-1 is mutated, further mutations on SP-2 and SP-3 increase nuclear localization.(60)

NFAT nuclear localization is accompanied by some relocalization of calcineurin from the cytoplasm into the nucleus. Calcineurin in the nucleus of stimulated cells maintains the dephosphorylated status and the nuclear localization of NFAT until Ca^{2+} entry is ended or calcineurin activity is inhibited. Once NFAT is rephosphorylated it is sending back to the cytoplasm ($t_{1/2} \sim 15\text{-}20$ min) by means of the nuclear export receptor Crm1 transporter.(60)(64) NFAT1: Crm1 interaction depends on NFAT phosphorylation state; phosphorylated NFAT1 exposes a Crm1-binding NES (nuclear export signal), while dephosphorylation results in loss or masking of a NES, preventing NFAT1 binding to Crm1. In this way, dephosphorylation regulates both the nuclear import and the nuclear export of NFAT1 by inducing an active conformation state that simultaneously exposes an NLS and masks an NES.(27)(60)(62)

II.1.1.3. Transactivation domain

Recent evidence suggests that NFAT transcriptional activity could be enhanced by modifications in the transactivation domains, which include an inducible phosphorylation site within residues 53–56 and certain kinases directed to N-terminal site. It is possible that depending on cell type, different kinases could exert their action on the inducible phosphorylation site of NFAT TAD. Such differential phosphorylation may recruit to the regulatory regions of NFAT target genes specific cell-type cofactors.(60)

If a mutation occurs in these serines NFAT transcriptional activity is suppressed. Cot-1 and Pim-1 kinases phosphorylate NFAT1 and NFAT2 respectively at positions different from those recognized by calcineurin. This phosphorylation results in an improvement of NFAT1 and NFAT2-dependent transactivation.(58)(62)



II.2. NFAT REGULATION: CALCIUM, CALCINEURIN AND NFAT KINASES

Different pathways could be implicated during Ca^{2+} /CaN signaling regulation. In T cells TGF- β suppresses tyrosine-protein kinase Tec kinase activity and thus Ca^{2+} influx; calcineurin independent control may be achieved by the Down syndrome critical region protein 1/Myocyte enriched calcineurin-interacting protein-1(DSCR1/MCIP1) family of endogenous calcineurin inhibitors, which sets up a negative feedback circuit where calcineurin/NFAT signals upregulate DSCR1/MCIP1 expression, to downregulate calcineurin activity(58).

II.2.1. NFAT translocation model

NFAT nuclear compartmentalisation constitutes the main mechanism for NFAT regulation, bypassing Ca^{2+} stimulus requirement for NFAT transcription genes and IL-2 production. NFAT nuclear accumulation depends on the maintenance of Ca^{2+} /CaN signaling level. (27)

Nuclear localization of NFAT1 occurs in two distinct steps. TCR ligation causes a conformational shift in NFAT1, and/or induces the release of a binding partner; this event seems to be calcium flux-independent or at least has relatively low threshold, because it is observed in both naïve and anergic T cells. The second step is the dephosphorylation and subsequent translocation of NFAT1, which obeys to calcium increase, and does not occur in anergic T cells. Both steps are independently regulated by multiple pathways.(61)

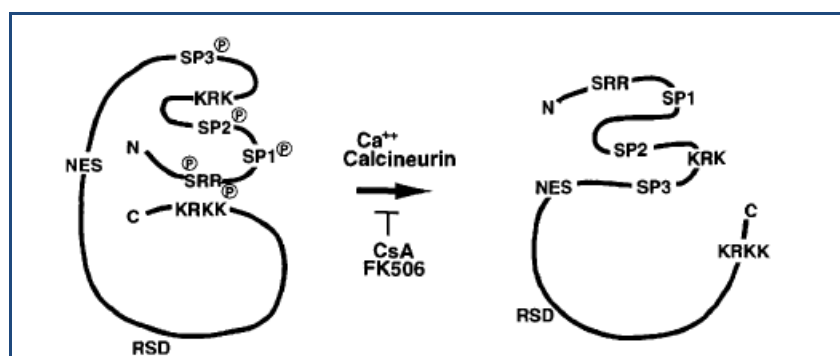

Figure 18. An hypothetical mechanism for NFAT translocation to the nucleus by means of 2 nuclear localization sequences.(27)



Multiphoton intravital microscopy in T cells has evidenced that while NFAT nuclear import was fast ($t_{1/2 \text{ max}} \sim 1 \text{ min}$), nuclear export was slow ($t_{1/2} \sim 20 \text{ min}$)(64). This seems consistent with the fact that in the nucleus NFAT must recruit the machinery for gene transcription.

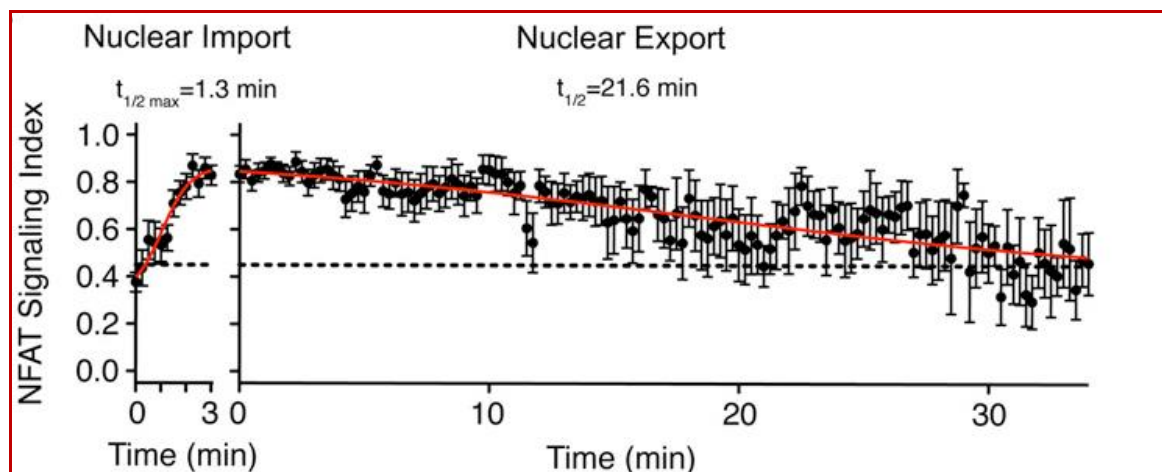

Figure 19. NFAT shuttling in T cells.(64)

$[Ca^{2+}]_i$ drops with a $t_{1/2}$ less than 3min, however after stimulus stops dephosphorylated NFAT persists in the nucleus for approximately 20min before being exported to the cytoplasm.(60) During this period nuclear NFAT continues to be transcriptionally active (NFAT memory phase) bound to gene-regulatory sequences for some time even after CaN inactivation or stimulus suppression (in particular by the disengagement of T cells from APCs)(64). However, not all NFAT target genes could be expressed during this lap, specially effector genes like $IFN\gamma$ suggesting a mechanism by which dynamic cell interaction variations translates into different gene expression programs(64). Indeed, not only the secretion but also the expression of $IFN\gamma$ is tightly linked to APC interactions. Then NFAT remains transcriptionally active for those genes that do not require AP1 cofactoring, like early growth response 2 protein (Egr2) which is a rapidly expressed gene and associates to tolerance. Depending on NFAT binding status at gene transcription will be the program to be activated; NFAT dimmers launch T cell tolerance gen transcription, whereas other NFAT DNA-binding factors, such as AP1, facilitate the activation of effector programs.(64)



Stable T cell-APC contacts may be necessary for T cells to receive instructive signals through means of secreted cytokines to the APC immune synapse. On the contrary, less stable contacts and more frequent APC disengagement increase the time a T cell spends in NFAT memory phase during its migration between APC encounters compared to the time due to direct APC contact. NFAT transcription course during memory phase together with the balance among APC interaction and NFAT memory times will contribute to shape the extent to which NFAT can cooperate with its different transcriptional partners to induce immunity or tolerance.(64) The brief biochemical effect of new APC encounters makes possible the expression of the EGR2 tolerance factor, but not of the immunity effector gene IFN γ , then under conditions leading to unstable APC interaction, NFAT activation in T cells is not reduced, but spread into a tolerogenic program, possibly enhancing the transcription of tolerance genes during NFAT memory phase.(64)

II.2.2. NFAT Kinases: NFAT phosphorylation

Phosphorylation determines subcellular distribution, DNA binding affinity, and NFAT proteins transcriptional activity.

In resting cells, constitutive maintenance kinases act in the cytosol to keep NFAT in a fully phosphorylated state inhibiting its translocation into the nucleus, while the synchronized action of several inducible and/or constitutive export kinases rephosphorylates NFAT in the nucleus and promotes its nuclear export and relocalization into the cytoplasm.(30)(40)

NFAT phosphorylation kinases are: CK1, protein kinase A (PKA), MAPK [p38, JNK], GSK3, mitogen activated protein kinase kinase (MEKK), extracellular-signal-regulated kinases (ERK), and DYRK 1A and 2. Some of them have a priming role, like DYRK1A and 2 and PKA, while CK1 and GSK-3 enable the phosphorylation of most of sites.(32)(63)



NFAT kinase	Kinase type	Substrate	Phosphorylation site
GSK3	Export	NFAT1	SP2
		NFAT2	SP2 and SP3
CK1	Export and maintenance	NFAT1	SRR1
DYRK1	Export	NFAT1 and NFAT2	SP3
DYRK2	Maintenance	NFAT1 and NFAT2	SP3

Figure 20 NFAT kinases and substrates.(30)

NFAT kinases insure NFAT cytosolic localization and reversible nuclear NFAT recycling into the cytosol once calcium signaling terminates.(32)

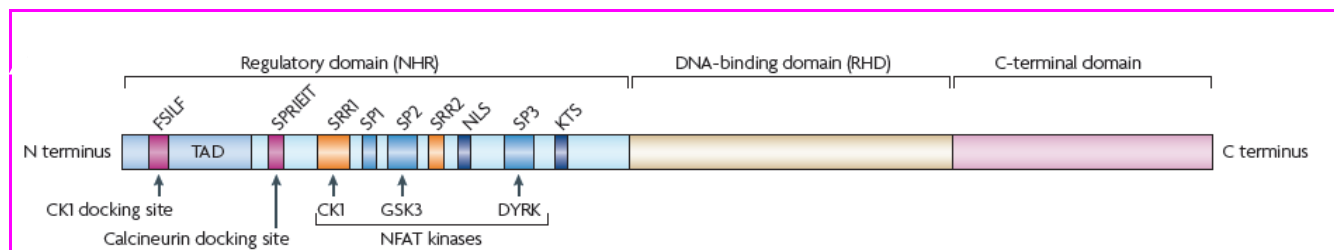

Figure 21. Kinases docking sites in NFAT structure.(30)

Comparative sequence analysis of NFAT isoforms, reveal that SRR1 region is extended in NFAT2–4, whereas SP2 and SP3 motifs are truncated in NFAT3, suggesting that NFAT proteins may be controlled by superposition of different assortment of constitutive and inducible kinases.(58)

CK1 and GSK3 are constitutive kinases implicated in NFAT nuclear export. CK1 is a maintenance and export kinase for SRR1 domain and anchors at a conserved motif near the N terminus of NFAT proteins; GSK3 acts only as an export kinase for the SP2 motif of NFAT1 and for the SP2 and SP3 motifs of NFAT2. GSK3 docking sites appear after “priming” phosphorylation by PKA or DYRK1A. CK1 and GSK3 phosphorylation of the SRR1 and SP2 motifs respectively, require priming phosphorylation of SP3 domain by DYRK1A and DYRK2 kinases. DYRKs kinases exert their roles depending on their



subcellular localization; cytoplasmic DYRK2 works as maintenance kinase, while nuclear DYRK1A is implicated in NFAT nuclear export.(30)

During TCR stimulation CD28 costimulatory receptor enhances PI3 kinase activation pathway and consequently AKT/PKB pathway. AKT activation hampers GSK3 and therefore NFAT nuclear export to the cytoplasm, enlarging NFAT nuclear residency.(58)

SP2 and SP3 kinases which retain NFAT1 in the nucleus and SP3 kinase involved in NFAT1 exit from the nucleus are not yet identified.

Mitogen-activated protein kinases (p38 and JNK) are inducible kinases engaged in NFAT nuclear export, by selective phosphorylation of NFAT proteins at the first serine of SRR1 motif; p38 phosphorylates NFAT1 and NFAT3, whereas JNK1 phosphorylates NFAT2 and NFAT4. This mechanism could facilitate the phosphorylation of the remaining serines in SRR1 by CK1. Therefore, depending on which MAPK pathways are switched on, a cell could express several NFAT proteins, but at a specific time only one isoform could be in the nucleus (although more than one isoform could coexist in the cytoplasm) which is responsible for the transcriptional activity. This postulate could serve to explain certain isoform-specific functions observed of NFAT proteins.(31)

JNK1 phosphorylates residues within the calcineurin binding domain of NFAT2, impeding CaN/NFAT2 interaction; however, the homolog region of NFAT1 is not phosphorylated, meaning that family members are under distinct regulation. Export kinases selective activation argues in favour of the fact that NFAT proteins may be susceptible of particular regulation in a single cell type.(62)



II.2.3. NFAT Transport regulation

II.2.3.1. Importins and Exportins

The nuclear–cytoplasmic ratio achieved by an NFAT protein includes CaN and NFAT kinase activities as well as the import and export rates of NLS- and NES-exposed forms. So far NFAT import receptor has not been established, but some authors have argued in favour of α subunit of the RCH1 (Rag cohort 1, also named LRR receptor-like serine/threonine-protein kinase RCH1) receptor; whereas the nuclear export receptor seems to be Crm1, the target of the nuclear export inhibitor leptomycin B, which preferentially binds phosphorylated NFAT1. In fact, CaN and the Crm1 compete for binding to NFAT through means of a nuclear export signal of NFAT to promote NFAT transcriptional function.(63) NFAT activity is then set by the balance of the import and export kinetics.(58)

II.2.3.2. Polyribosylation

Polyribosylation of the RHR domain of NFAT proteins by the poly-adenosine diphosphate -ribose polymerase 1 (PARP-1), stabilizes NFAT proteins and promote their activity in T cells, enhancing DNA-binding, modulating the expression of certain cytokines transcribed (i.e. IL-2 and IL-4) and influencing NFAT1 nuclear export.(30)

II.2.3.3. RNA-protein scaffold complex

NFAT nuclear import and trafficking are also regulated through a mechanism mediated by non-coding RNAs. Under resting conditions, NFAT proteins are kept in the cytoplasm, phosphorylated and making part of a complex composed by the NRON and several proteins also implicated in NFAT nuclear translocation. (28)(30)

The RNA-protein scaffold complex holds: phosphorylated NFAT; the long intergenic noncoding RNA (lincRNA), NRON; a scaffold protein IQ motif with GTPase activating protein (IQGAP); NFAT kinases (CK1, GSK3 and DYRK); a leucine rich repeat kinase 2 (LRRK2); and calmodulin to assist during phosphorylation/dephosphorylation events.(40)(65)



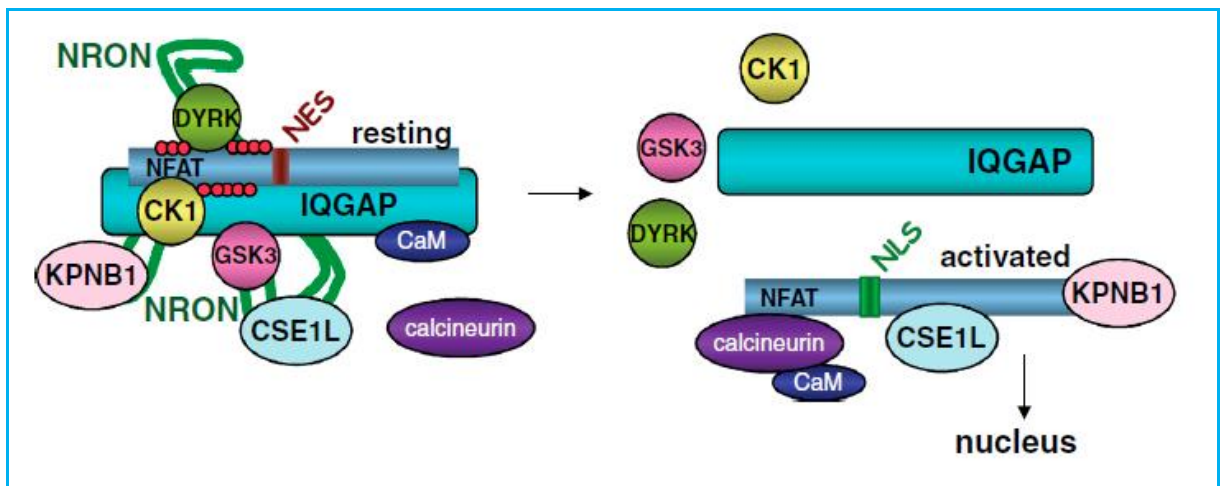

Figure 22. NFAT RNA-scaffold protein complex before and after activation.(65)

This scaffold complex localizes NFAT adjacent to the maintenance kinases (to keep it inactive in the cytoplasm, preventing from CaN access and to store nuclear transport factors), and calmodulin required for calcineurin activity.(65) In resting cells NRON stabilizes IQGAP protein in the scaffold complex. Under stimulated conditions calcineurin interaction, dephosphorylates NFAT triggering a conformational change by which NFAT is released from IQGAP1 and NFAT kinases control, allowing association with nuclear import proteins, and finally with other transcriptional regulators in the nucleus.(65)

II.2.3.4. Sumoylation

Sumoylation is a post-translational modification of proteins that serves to regulate protein-protein interactions by the covalent fixation of small ubiquitin like modifier (SUMO).(28)

In the case of NFAT sumoylation influences nuclear retention and transcriptional activity.(28) NFAT1 carboxy-terminal domain contains sumoylation sites, which are not conserved among all NFAT proteins, suggesting the existence of a specific regulatory mechanism that differentially controls NFAT1 and NFAT2B nuclear exit.(28)(31)



NFAT1

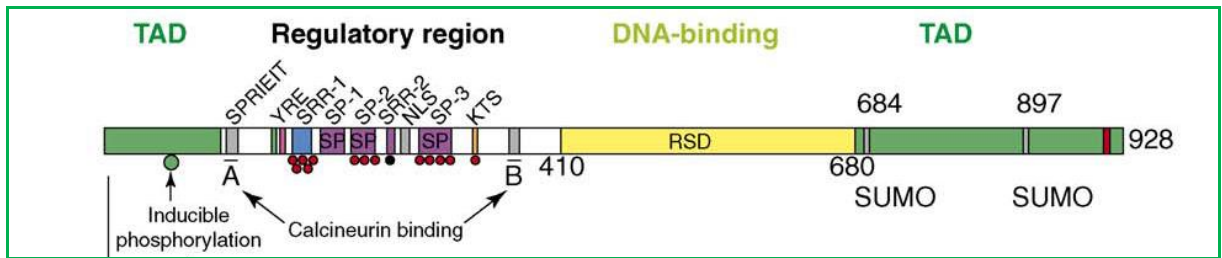

NFAT2B/C

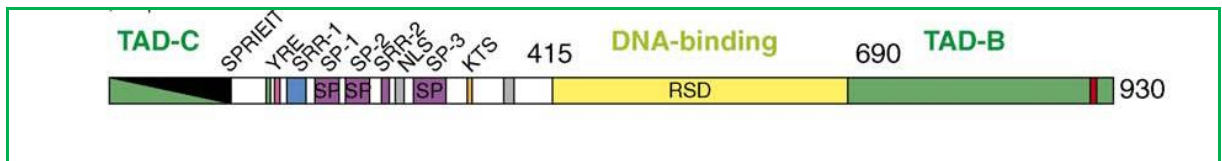

NFAT2αA

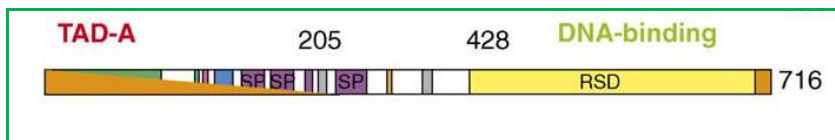

Figure 23. NFAT structures and SUMO domains.(66)

NFAT complexes might also be involved in gene silencing through transcriptional repressors and members of the histone deacetylase family.(48)(67) In particular sumoylation of NFAT2C recruits histone deacetylases (HDACs), resulting in IL-2 promoter silencing.

During T cell differentiation NFAT2C expression decreases in favor of the NFAT2A inducible form, which is not susceptible to sumoylation changes, highlighting a specific mechanism involved in the regulation of cytokine expression in naïve T cells.(28)



II.2.3.5. 14-3-3 binding: a key regulator of signal transduction events

14-3-3 family of ubiquitous proteins includes seven isotypes in mammalian cells that play numerous diverse roles in intracellular signaling, may acting as a sequestering molecule, a chaperone, or an adaptor, depending on the extent to which the binding motif matches the optimal consensus sequence.

NFAT factors share the capacity to bind to the 14–3–3 protein and this phenomena seems to be related to phosphorylation of phosphoserine sites localized next to the NLS.

NFAT NLS blockage by a NES-bearing 14-3-3 dimer furnishes a mechanism through which NFAT is inhibited.(62)

II.2.3.6. Other mechanisms modulating NFAT trafficking

HOMER2 and HOMER3 are cytoplasmic scaffold proteins which compete with CaN for NFAT binding, contributing to cytosolic NFAT stabilization and impeding its dephosphorylation by calcineurin.(30)

In effector T cells caspase 3 also influences NFAT1 expression; two potential caspase 3 cleavage sites have been identified in the TAD domain of NFAT1, and mutation of these sites increases NFAT1 activity.

An orchestrated process involving CaN, NFAT kinases and posttranslational mechanisms conforms an intrincated signaling network to regulate distinct NFAT proteins in response to specific cellular stimuli.(30)



II.3. NFAT2 SELFREGULATION: AN ISOFORM-SPECIFIC MECHANISM

NFAT2 has three different isoforms, NFAT2A, NFAT2B and NFAT2C, as a result of alternative splicing, with different length and mechanism of expression. NFAT2B and 2C are constitutively of naïve T cells, while the smaller isoform 2A is mainly found in effector T cells.(58) NFAT2 lacks the entire C-terminal domain, but it has two N-terminal domains, one of which is not highly acidic, contrary to other NFAT proteins.(30) NFAT2A α full induction in primary T and B cells requires more than 24h activation, whereas upon T cell secondary stimulation, occurs within a few hours. In resting /naïve T cells, P2 activity results in the generation of three β isoforms (A,B,C).

Contrary to NFAT1 gene, constitutively expressed in peripheral effector lymphocytes, NFAT2 transcription, is strongly induced upon stimulation in peripheral T and B cells, resulting in the major synthesis of NFAT2A α short isoform, only when NFAT2 threshold is achieved the selfregulatory loop is capable to maintain adequate levels of NFAT2A α expression guaranteeing activated committed state and cell differentiation program.(61)(68) This feature is a remarkable property of effector T helper cells, and the bias to NFAT2A α synthesis is pivotal for tissue differentiation (31)(66) and explains why NFAT2 deletion has more profound deleterious consequences for cell development than the suppression of other NFAT family members.(30)

NFAT2A α is suppressed under anergic conditions in Tregs, and in Th9 (CD4⁺ type producing mainly IL-9 and other cyto and chemokines) and in Th17 (CD4⁺ - IL-17 phenotype) cells. The suppression in Tregs could be explained by FOXP3 binding to the NFAT2 P1 promoter in addition to reduced Ca²⁺ influx/CaN activity and, thereby, conducting towards NFAT2 inhibition.(68)

NFAT2A α expression can be regulated both in a switch-like and in a gradual manner by different stimuli. The switch-like mechanism depends on CaN activity and responds to a positive auto-regulatory feedback loop.(68)



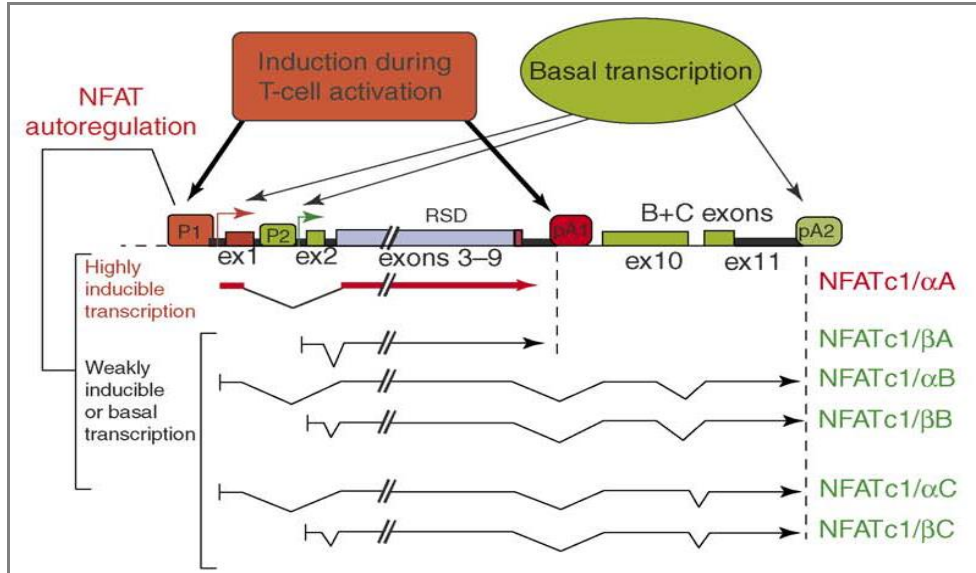
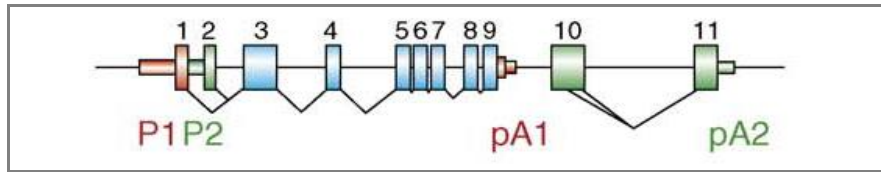

Figure 24. Representation NFAT2 gene expression hypothetical model showing P1 and P2 promoters and the two polyA addition sites, pA1 and pA2.(68)

Red color indicates specific sequences for NFAT2 α , green colors are sequences of β isoforms, and blue the common sequences to all isoforms.

NFAT2 control is achieved through two transcriptionally active promoters P1 and P2, the alternative splicing site and two poly A sites.(66) P1 transcripts encode NFAT2 proteins bearing the N-terminal α peptide of 42 aminoacids (aa), whereas P2 transcripts code for proteins with the N-terminal β peptide of 29 aa. C termini comprise either a short stretch of 19 aa in the A isoform, or longer stretches of 128 aa in the B isoform or 246 aa in the C isoform. B and C isoforms result from alternative splicing and polyadenilation (polyA) addition at the distal site pA2. Besides P1 activity, NFAT2 α RNA needs polyadenylation at the proximal polyA site A1 near the end of exon 9.

The initial phase of NFAT2 transcription in naïve CD4⁺ T cells is controlled by P2 promoter which is constitutively active in resting T cells, but upon T cell activation P2 promoter activity decreases towards P1 induction to trigger NFAT2 α synthesis. Optimal P1 activity requires the synchronized cooperation of Ca²⁺/CaN, NF- κ B and MAP/p38-kinases signaling pathways, and the involvement of the proximal polyA site pA1. (68)



Similarly to what happens with IL-2 promoter, the inducible P1 promoter requires more than one signal for triggering its own induction. In T cells one of the signals is provided by a sustained increase in cytosolic Ca^{2+} , which stimulates NFAT transcriptional activation while the other one activates PKC and other protein kinase pathways, suggesting that both TCR and costimulatory signals are required for complete P1 NFAT2 induction.

In immune responses NFAT2A α and NF- κ B factors collaborate in the clonal expansion and differentiation of lymphocytes. NF- κ B together with CREB, activating transcription factor 2 (ATF-2) and FOS activator factors will exert graded effects on NFAT2A α levels once CaN activity threshold is surpassed. p38 protein kinase target ATF-2 supports NFAT2 induction in T cells, while CREB binding might be responsible for P1 promoter weak transcriptional activity upon TCR costimulation in T cells.

At the end of an immune response, most of lymphocytes undergo to apoptosis when they hold an excess of NFAT, whereas those with an “optimal” ratio between NFAT2A α and NF- κ Bs will survive, ensured by NFAT2A α selfregulation.

II.4. NFAT TRANSCRIPTIONAL ACTIVITY

Calcineurin has the role to activate NFAT for gene transcription. NFAT binding to the nuclear p300-CREB binding protein (CBP) coactivator family also contributes to NFAT transcriptional activity; this bounded fraction of NFAT could be posttranslational modified by phosphorylation or acetylation.(63)

The high flexibility of the linker region between the N-terminal domain of the RHR, and the C-terminal domain, are able to adopt distinct orientations according to their partners during transcription complexes; this property directs the attachment of specific transcriptional comodulators, and the integration of signals provided from distinct pathways.(31)(58)

In the nucleus, NFAT factors recognize a consensus sequence A/TGGAAA within target promoter elements and bind DNA either as homodimers or heterodimers;(67) (68) as dimers at κ B-like response elements, and as cooperative complexes with FOS



and JUN at NFAT:AP1 composite sites (31)(58) and forkhead box P-family proteins (FOXP2 and FOXP3) to turn on or to inhibit specific transcriptional programs.(40)

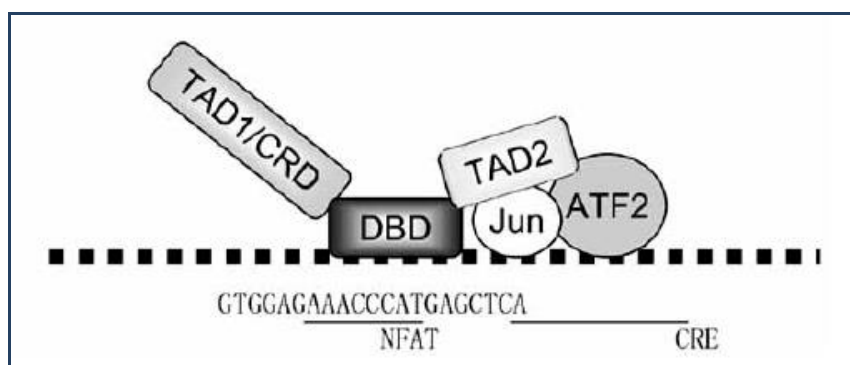

Figure 25. NFAT partners in TNF- α transcription.(69)

NFAT could inhibit gene transcription by: recruiting corepressors or cooperating with transcriptional inhibitors during DNA binding. There are two classes of NFAT target genes, depending on AP1 cooperation(58), according to which binding partners are involved.

NFAT:AP1 collaborative model is recognized in several cytokine promoters/enhancer regions such as IL-2, IL-4, IL-5, granulocyte-macrophage colony-stimulating factor (GM-CSF), CD40L, IFN- γ , IL-13, CTLA4, TNF- α , IL-8 and E-selectin.(58) NFAT:AP1 launches a program gene to activate immune responses, but in the absence of AP1, NFAT triggers T cell anergy program, blocking T cell activation and proliferation.(31)

NFAT:FOS-JUN complexes conceive an extensive network of protein–protein contacts, reinforcing their stability and cooperative nature, integrating several signaling pathways and processes.(31)(58) In NFAT:FOS-JUN complexes NFAT and AP1 are locally opposed elements which establish a true “composite” site of ~15-bp length; this is a strong interaction more stable and with higher affinity than the individual binding of the proteins alone.(48) FOS–JUN contact residues are situated mostly in the NFAT N-terminal RHR domain (almost completely conserved in NFAT1–4 but absent in NFAT5). However, their polar interactions are not strong enough as to stabilize the NFAT:AP1 complex outside of the DNA binding site, suggesting that this DNA composite site is crucial for transcription factors.(58)



There is also strong evidence to support NFAT and FOXP3 cooperation. Even though, FOXP3 and AP1 dock to the same NFAT DNA region, the residues by which interaction is set are not identical. Interestingly, NFAT:FOXP3 complex works as a repressor while the NFAT:AP1 complex promotes IL-2 expression; by contrast, FOXP3 and NFAT collaborate to upregulate cytotoxic T lymphocyte Antigen 4 (CTLA-4) and CD25 expression.(33)

AP1 transcription factor is regulated by MAPK pathway; c-FOS gene is controlled by ERK, and c-JUN gene by c-JUN N-terminal kinase (JNK). After TCR activation, both proteins are phosphorylated by their MAPK in order to migrate into the nucleus, where they heterodimerize (AP1) and bind to the IL-2 promoter complexed with NFAT. MAPK phosphatases (MKPs) inhibit MAPK pathway. MKP5 and 6 downregulate T cell activation suppressing MAPK target's activity. MKP6 interacts with CD28 cytoplasmic tail; whereas MKP5 acts on JNK and p38. It is required for T cell proliferation and T cell activation threshold modulation of the secondary immune response to infection.(70)

Transcription partner	Interaction site	Effect
AP1 (FOS, JUN)	Many cytokine-gene promoters	Positive synergy
C/EBP	PPAR- γ promoter	Positive synergy
MAF	IL-4 promoter	Positive synergy
EGR1 and EGR4	Tnf promoter	Positive synergy
GATA3	IL-4 3' enhancer	Positive synergy
ICER	Many cytokine-gene promoters	Inhibition of NFAT activity
IRF4	IL-4 promoter	Positive synergy
MEF2	NUR77 promoter	Positive synergy
OCT	IL-3 enhancer	Positive synergy
p21 ^{SNFT}	IL-2 promoter	Inhibition of NFAT activity
PPAR- γ	IL-2 promoter	Inhibition of NFAT activity
T-bet	IFN- γ 5' enhancer	Positive synergy

Figure 26. NFAT transcriptional partners.(31)



Although proximal promoter regulation is critical for gene expression, distal regulatory regions have also significant effects. Distal regulatory elements are characteristic of NFAT target genes in T cells; in particular, distal enhancers exist in all cytokine genes such as IL-3, GM-CSF, IL-4, IL-10, and IFN- γ , which most often correspond to highly conserved non coding sequences (CNS). Enhancers may be intronic, at 5' of the proximal promoter or at 3' extreme of the gene; allocating NFAT binding sites and the sites for constitutive or lineage-specific transcription factors, then conferring cell-type specificity for gene expression.(58)

Furthermore, NFAT proteins can regulate gene expression at two different levels: through an open loci binding immediately available for transcription, such as the IL-2 locus; or through a close loci, which requires remodeling to permit transcription factors access to the promoter to switch on gene expression.(31)

In immune system NFAT proteins participate in the transcription regulation of a vast number of inducible genes, principally involved to cell–cell interactions, such as IL-2, IL-3, GM-CSF, IL-4, IL-5, IL-10, IL-13, IFN- γ , TNF- α , CD40L, FasL, CD5, Igk, CD25, IL-8, MIP-1 α and cyclooxygenase 2. The transcriptional partners for IL-2, GM-CSF, IL-3, IL-4, MIP1 α and Fas ligand mRNAs expression are JUN and FOS; whereas TNF α and IL-13 promoter activity takes place without AP1 recruiting proteins.

NFAT can trigger IL-2 transcription binding to its promoter by cis (via TCR signaling) or trans [via Chemokine Receptor 5, CCR5] regulatory regions.(62)

CCR5 expression promotes cell proliferation after T cell activation favoring IL-2 production and CD25 expression, while simultaneously IL-2 upregulates CCR5. This interaction might ensure survival, expansion, and migration of antigen-specific memory as well as Th1 cells during the effector phase of the adaptive immune response.

NFAT accumulation mediates IL-2 expression in memory, but not in naïve CD4⁺ T cells. Memory T cells have less stringent activation requirements than naïve cells and are more susceptible to activation. CCR5 might play as a costimulatory receptor for memory T cells during secondary immune responses.(71)

Summarizing, NFAT proteins are thus important integrators of calcium signaling with many other signaling pathways in T cells.



II.4.1. CaN/NFAT signaling and Thymocyte development

Calcium/calcineurin signals also regulate thymocyte proliferation and the development of immature double negative thymocytes (those not capable to express CD4 or CD8) into mature single positive (SP) cells to be drop into the periphery.(31)

Together with CaN/NFAT signaling other pathways such as those involving tyrosine-protein kinase LCK (LCK) or RAS/MAPK participate in the survival of a double positive thymocyte to become a mature T cell.(31) However, calcineurin inhibition by CNIs causes defects in thymocyte development impairing DP to SP transition and inducing defects in negative selection.

CaNA β knockout mice experiments results in a defect in T cell activation which is associated with NFAT proteins imperfect activation and a lower number of SP thymocytes, pointing that CaNA β is involved in SP selection.

Furthermore, NFAT4 has been shown to promote DP to SP transition; NFAT4 activation in response to TCR engagement could be critical during positive selection and SP cell survival. NFAT1 and NFAT4 knockout mice developed a hyperproliferative phenotype due to apoptotic impairment caused by defective CD95L expression or hyperreactivity after TCR engagement. On the contrary, NFAT2-deficient cells are hyporesponsive, suggesting that NFAT1 and NFAT4, but not NFAT2, might control the threshold for TCR activation.(31)

II.4.2. NFAT and T helper differentiation

During T helper differentiation these cells are transformed into two distinct populations (Th1/Th2) with characteristic patterns of cytokine expression and specific immune functions. Th1 or Th2 cell fate is driven by the antigenic stimulus, the APC delivered signal and the signals received from specific cytokines (IL-12 and IL-4 respectively). Epigenetic changes triggered by TCR and cytokine-mediated signaling cascade also account for the specific patterns of cytokine expression.(31)

NFAT proteins cooperates with signal transducer and activator of transcription (STAT) factors at cytokine regulatory regions, initiating significant changes in DNase I



hypersensitivity and histone acetylation throughout the locus leading to the selective expression of Th1/Th2 cytokine gene profile.

In Th1 cells, NFAT proteins cooperate with STAT4, in response to interleukin-12 receptor engagement, inducing IFN- γ expression and other proinflammatory cytokines such as IL-2, IL-10, IL-12, IL-18, IL-27, TNF α , β . IFN- γ receptor downstream signaling promotes STAT1 activation and translocation to the nucleus, then inducing T-bet (T box family transcription factors: T-bet and eomesodermin) expression.

In Th2 cells (which secrete IL-4, IL-5, IL-6, IL-9, IL-13 and IL-17E), NFAT and MAF proteins lead IL-4 expression. Signaling through IL-4 receptor activates STAT6, inducing GATA-binding protein 3 expression. Both T-bet and GATA3 expression are ensured by positive auto-regulatory loops.(31)

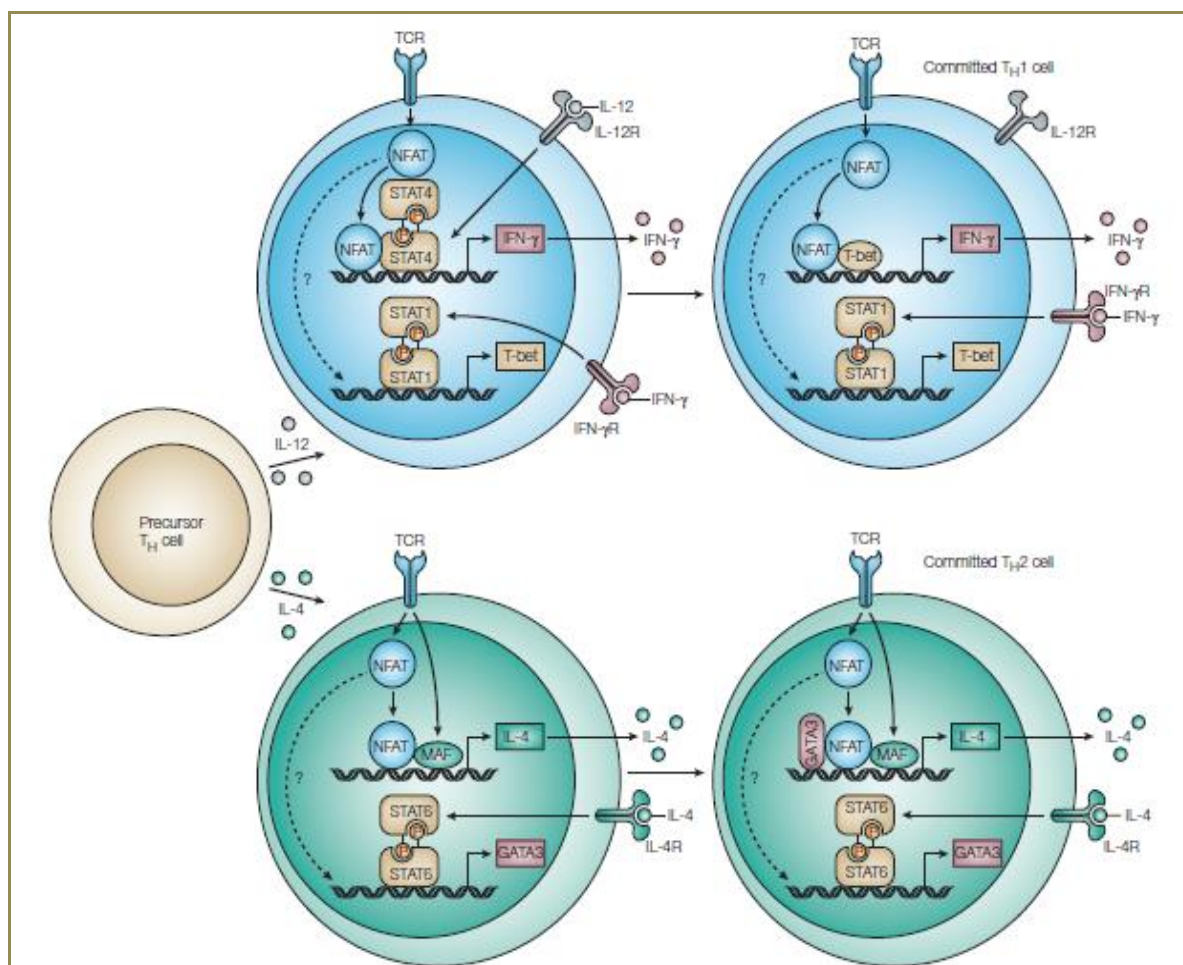

Figure 27. NFAT and helper T cells differentiation.(31)



NFAT1 and NFAT2 are functionally redundant but they play a role in both branches of T cell differentiation. NFAT1 interacts with GATA3 to maintain Th2 phenotype, however the NFAT1- GATA3 interaction employs a different site from AP1 cofactoring.(48) NFAT2 is also necessary for Th2 cell differentiation. NFAT1 and NFAT4 maintain Th1 pattern and act as repressors of Th2 cell differentiation. Divergent NFAT activation and Th cell fate are also influenced by costimulatory molecules other than CD28 (i.e. ICOS).(31)

II.4.3. NFAT and T regulatory FOXP3 cells

Besides Th1/Th2 phenotype, NFAT also enables T regulatory cells (Tregs) function. Tregs upregulate the expression of NFAT anergy associated genes, suggesting that common mechanisms may be shared by the hyporesponsive state of anergic T cells and Tregs.(31) Tregs are a subset of thymically derived T cells representing about 2–10% of all T cells in the periphery.(28) Tregs are CD4⁺CD25⁺FOXP3⁺ T cells subset characterized by the expression of the transcription factor FOXP3, and are crucial for suppressing activation of autoreactive T cells in the periphery and for preventing autoimmunity.(30) Tregs do not proliferate nor secrete cytokines in response to stimulus.

FOXP3 has been recognized as the master regulator of Tregs differentiation and development in the thymus and has a key role in maintaining competent Tregs activity in the periphery.

In Tregs cells FOXP3 expression is regulated by several SMAD3 (STAT5 mothers against decapentaplegic homolog 3) factors and NFAT downstream of TCR signals, CD28 costimulatory signals, and cytokine signals. NFAT binds both promoter and enhancer regions of the FOXP3 gene. Conserved non-coding sequence 1 (CNS1) at 5'enhancer position binds NFAT and SMAD3, both required for chromatin modification and FOXP3 induction during induced regulatory T (iTregs) cell differentiation. A second conserved non-coding sequence CNS2, FOXP3 and the runt-related transcription factor 1–core binding factor- β complex (RUNX1–CBF β) form an auto-regulatory loop. (33)



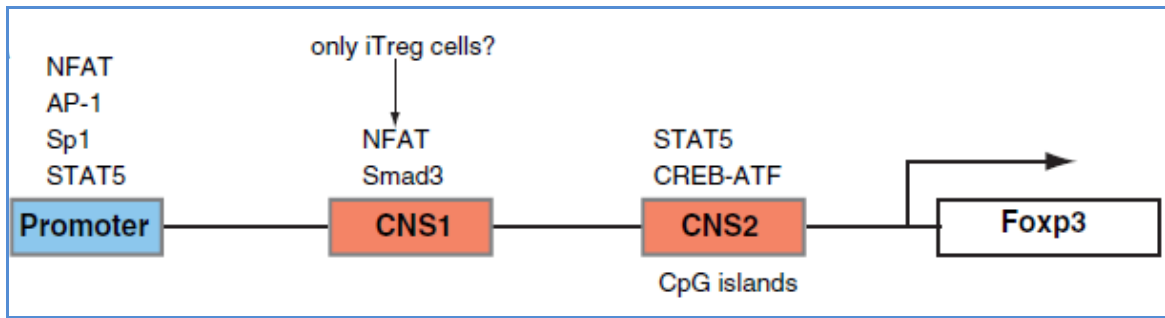

Figure 28. Diagram of the structure of FOXP3 gene.(33)

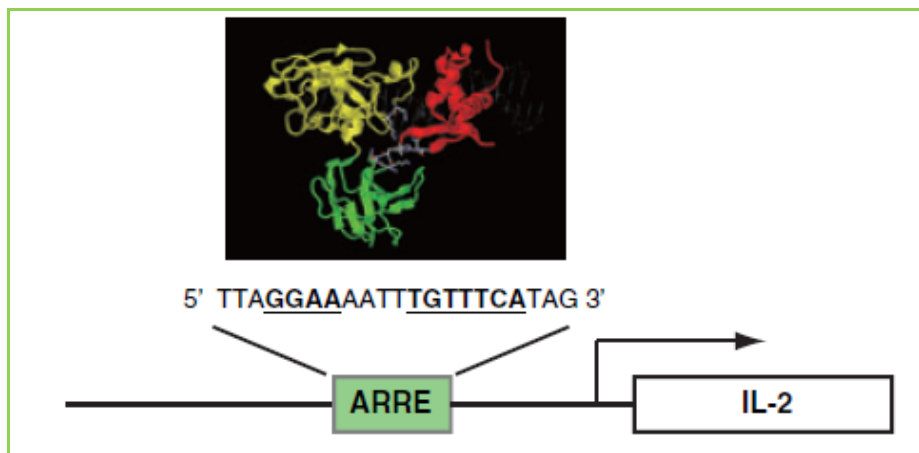

Figure 29. Diagram structure of NFAT:FOXP3 on IL-2 promoter. (33) Antigen-receptor response element (ARRE), binds NFAT–FOS–JUN complexes in activated T cells.

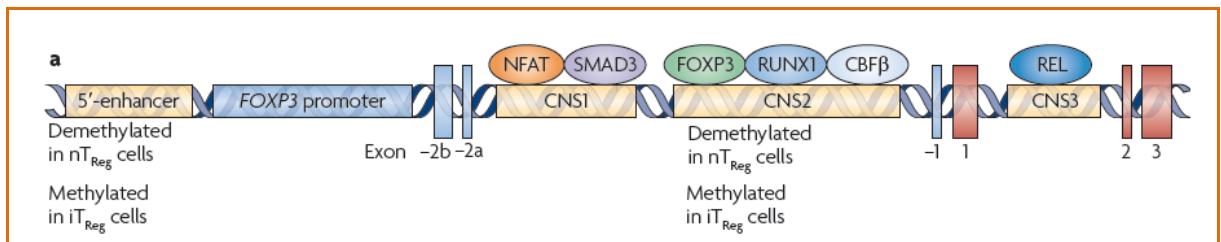

Figure 30. Transcriptional regulation of FOXP3 by NFAT in Tregs cells.(30)

During transcriptional regulation of Tregs cells, NFAT cooperates with FOXP3 to suppress IL-2 production. CNS-2 is demethylated in naïve Tregs whereas is highly methylated in induced Tregs cells.(33)



A third conserved non-coding sequence 3 (CNS3) binds to REL (c-Rel) and is required for FOXP3 expression by natural Tregs (nTregs) cells. Methylation status of 5'-enhancer and CNS2 sequence during development characterizes nTregs (with stable FOXP3 expression) and iTregs (methylated) cells.(33)

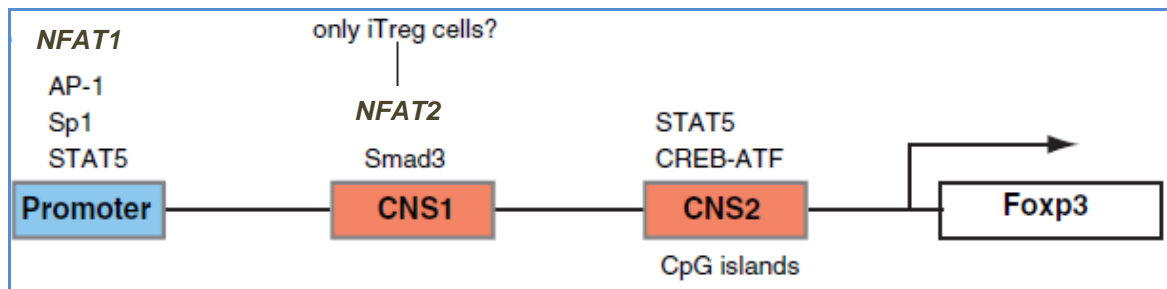

Figure 31. FOXP3 interaction sites for gene transcription.(30)

NFAT2 binding to 5'enhancer of FOXP3 gene occurs thereafter whereas NFAT1 binds to the promoter, pointing that NFAT2 maintains FOXP3 expression, and constitutes the major isoform in induced Tregs cells. Calcineurin inhibitors stop T regs induction (30) interfering selectively with natural regulatory T cells thymic production.(33)

Besides FOXP3, other genes are expressed in Tregs cells, including CD25, CTLA-4, and glucocorticoid-induced TNF receptor (GITR).(30)



Figure 32. Genes expressed in Tregs cells.

If NFAT:FOXP3 interaction is disrupted the resulting outcome is the lost of Tregs suppressive capability. If both NFAT1 and NFAT4 are deleted CD4⁺ T cells lost their susceptibility to become suppressed by Tregs.(28)



II.4.4. NFAT control of T cell fate: Activation or Anergy?

As previously discussed NFAT has an important role as transcriptional regulator in both naïve and differentiated effector T cells, but it is also involved in T cell tolerance.(30)

TCR engagement in the absence of costimulatory signals leads to NFAT activation, but if AP1 concomitant activation is impaired, T cells are driven to anergy. Under this scenario the activation of a Ca^{2+} /CaN pathway is directed towards an intrinsic program of self-inactivation and the formation of NFAT homodimers on DNA elements with appropriate palindromic sequences which induce the expression of genes such as GRAIL and CASPASE3 (28)(30), which damp TCR signaling and therefore cytokine transcription (i.e. IL-2), conferring a state of functional unresponsiveness to the cell.(28) Anergy cells are also characterized by reduced PLC γ activation and calcium mobilization, highlighting a fault in calcium signaling. Diacylglycerol kinase- α (DGK α) encharged of DAG depletion is potentiated in anergic T cells, thereby blocking downstream signal transduction. A global degradation and destabilization of the immunological synapse as well as the silencing of IL-2 expression take place during anergy.

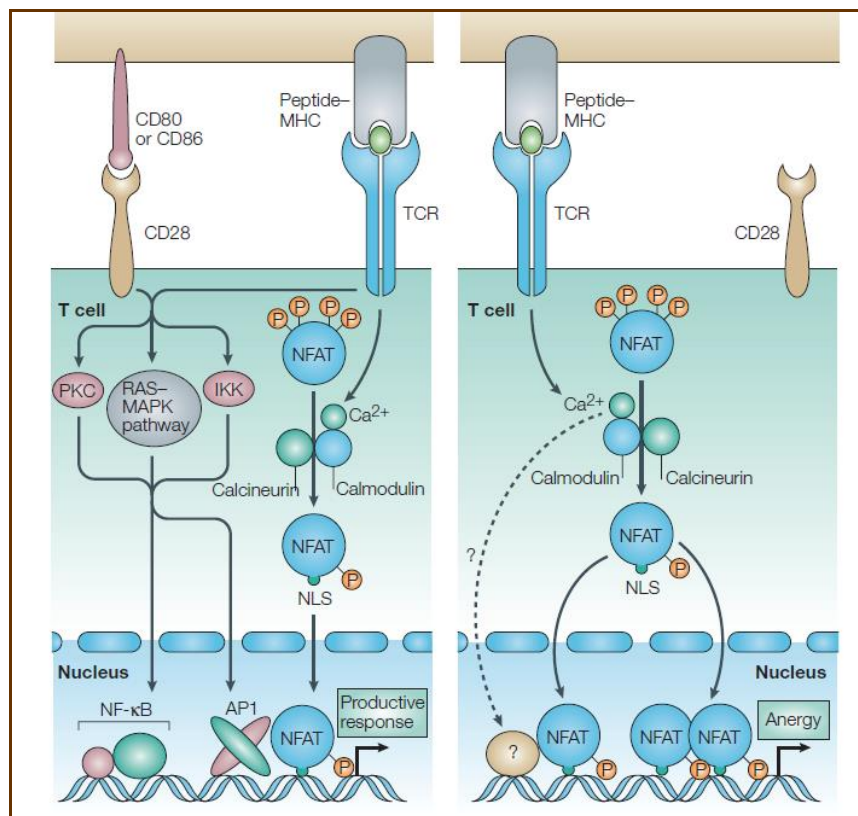

Figure 33. T cell activation versus T cell anergy.(31)



The anergy-inducing genes which are under NFAT positive regulation are: *casitas B-lineage lymphoma B (CBL-B)*, *itchy homologue E3 ubiquitin protein ligase (ITCH)*, *gene related to anergy in lymphocytes (GRAIL)*, *caspase 3*, *IKZF1 family zinc finger 1_ (IKAROS)*, *groucho-related gene 4 (GRG4)*, *deltex 1protein (DTX1)*, *early growth response 2 (EGR2)* or *EGR3*, *receptor-type protein tyrosine phosphatase-κ (RPTPκ)* and *protein tyrosine phosphatase 1B (PTP1B)*.(30) Almost all the same repressors of T cell activation by calcium-NFAT signaling have also been identified in anergic T cells (28) reinforcing the hypothesis of common shared mechanisms.

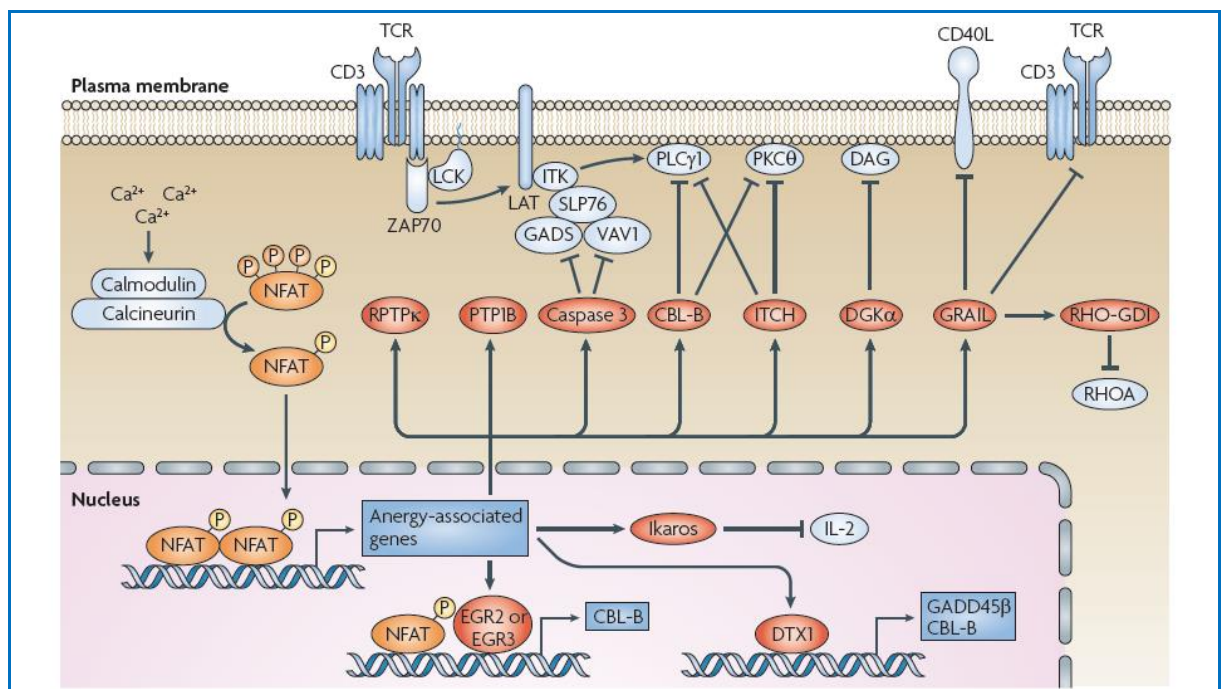

Figure 34. NFAT and T cell anergy.(30)

Although NFAT1 and NFAT2 DNA-binding REL domain is highly homolog (~70%), their translocation patterns after stimulation are not the same in naïve and anergic T cells, suggesting that NFAT isoforms are sensitive to different cytosolic calcium levels and thereby to calcineurin activity.(72) In fact during anergic T cell stimulation the main NFAT isoform induced is NFAT2 instead of NFAT1. In this sense NFAT2 seems to obey to a preferential activation by means of reduced calcium signaling, indicating that NFAT2 is mainly involved in the expression of anergy related genes.(61)



Consistent with a calcium deprived phenotype, NFAT1 translocation into the nucleus is inhibited or at least delayed in anergic T cells probably due to a decrease in nuclear import (due to reduced calcineurin activity) or an increase in nuclear export (via activation of nuclear NFAT kinases). If NFAT kinase activity increases, lower Ca^{2+} flux reduces calcineurin activity enough to shift NFAT1 nuclear balance from import to export. (72)

NFAT1 and NFAT2 reciprocal regulation in naïve and anergic T cells indicates that although NFAT1 is the driven isoform of a productive immune response, NFAT2 might be crucial for the control of T cell tolerance dependent genes.(61)(72) A deeper analysis of the NFAT1 and NFAT2 nuclear translocation model reveals that their reciprocal regulation occurs during dephosphorylation before nuclear translocation.

NFAT1 and NFAT2 nuclear localization is set by the balance between the rates of NFAT CaN dephosphorylation and NFAT kinases rephosphorylation of the same serine residues to promote nuclear export; by this means NFAT2 subcellular localization is commanded principally by calcium/calcineurin activity, rather than rephosphorylation and nuclear exit by JNK.(61)

II.4.5. Redundant vs. non-overlapping functions of NFAT proteins

Redundancy in some NFAT regulated functions could be attributable to their high degree of similarity among the RHR of the NFAT proteins that confers common DNA-binding specificities and partner interactions.(31) Despite NFAT1 and NFAT2 share high degree of homology, they are not redundant in T cells.(61)

NFAT1, NFAT2 and NFAT4 are coexpressed in peripheral T cells and they become activated in response to TCR engagement, however NFAT1 and NFAT2 are the main isophorms; thereby they might overlap in their function despite their different expression. As previously said, NFAT2 differs from NFAT longer proteins because the short C-terminal peptide is lacking, so the second TAD-B/repressor domain is missing.(68) (Figure 15) This feature allows NFAT2 to assemble to diverse types of transcriptional complexes in the nucleus.(58)



NFAT1-deficient T cells are forced toward a Th2 response (IL-4), while NFAT2 knockout cells show a Th1 bias (IL-2, IFN γ). Strong Ca²⁺ signaling during stimulation may skew T cells toward a Th1 program via NFAT1 activation, whereas calcium signals below the threshold would preferentially sustain NFAT2 activation, driving cells toward a Th2 response.(61) Notwithstanding NFAT redundancy in immune system, significant functional impairments arise when two or more NFAT proteins are inhibited. In T cells NFAT1 and NFAT2 deletion ceases cytokine production; and NFAT1, NFAT3, and NFAT4 deletion results in striking defects in axonal outgrowth in the central and peripheral nervous systems. This behavior argues in favour that some functions may depend on the balance of specific NFAT proteins binding to genes promoter at a concrete time during T cell activation or differentiation.(31)

Different cell-specific expression levels (NFAT4 vs NFAT1 or NFAT2), regulation mechanisms (NFAT2 α selfregulation) or interaction versatility with partnerships help to explain why certain T cell functions are particularly regulated by different NFAT proteins.(31)

NFAT1 depletion leads to hyperproliferation of peripheral T cells, and unresponsiveness to tolerizing stimuli. Similarly, NFAT1 and NFAT4 knockout mice develop a lymphoproliferative disorder, with decreased threshold for T cell activation, independent of costimulation.(28) Evidence supports NFAT1/NFAT4 role in TCR responsiveness, suggesting the existence of non-overlapping functions between the different NFAT isoforms expressed in T lymphocytes (NFAT1, NFAT2, and NFAT4).(28)

NFAT1 and 2 exert opposite effects on activation induced cell death (AICD) of peripheral B and T cells, which is one of the ways for inducing apoptosis. In T cells AICD is under the control of NFAT C-terminal TAD, which is missing in NFAT2, explaining why NFAT2 is an anti-apoptotic factor promoting cell cancerogenesis, especially the NFAT2 α isoform, whereas NFAT1 seems to be pro-apoptotic.(68)



II.5. NFAT AND INNATE IMMUNITY

NFAT signaling confers innate immune protection and regulates homeostasis of innate cells committed in host protection. NFAT contribution to innate and adaptive functionality of the immune cells helps to explain the higher rates of infection observed in patients who receive calcineurin inhibitors or other immunosuppressive drugs.(73)

As NFAT also modulates immune homeostasis through the transcription of growth factors, such as GM-CSF and IL-2, CNIs exposure may exert a significant effect on innate immune homeostasis, in fact innate immunity suffers several consequences due to NFAT proteins inhibition due to NFAT signaling implication in different cell types. Myeloid cells, granulocytes and dendritic cells (DC) have proinflammatory properties involved in adaptive immunity regulation, and are key mediators of early responses to pathogens. NFAT pathway inhibit myeloid activity through the modulation of genes associated to cell cycle progression and apoptosis, pointing that CaN/NFAT signaling inhibition increases myeloid cells development. NFAT signaling in myeloid cells regulates inflammation through leucine-rich repeat kinase 2 (LRRK2) which modulates the interaction between NFAT and the NRON scaffold complex; thereby LRRK2 cytoplasmic levels indirectly regulate NFAT translocation into the nucleus. In the absence of LRRK2, macrophages increase the levels of inflammatory cytokines, including IL-12 and IL-6. In most of the innate cells NFAT pathway is triggered after pattern recognition receptors (PRR) activation, so when, innate cells impaired in NFAT signaling are exposed to microbes they experiment changes in their transcriptional profile and phenotype, modifying the adaptive immunity success, vindicating in part the augmented susceptibility to fungal and viral infections exhibited by transplant recipients on CNIs treatment. GM-CSF is implicated in DC and granulocytes development and regulates neutrophils deliverance from the bone marrow.(73)

Another NFAT pivotal roles in immune cells is to control the expression of immunomodulatory cytokines, early growth response 2 and 3 (EGR2, EGR3), and cyclooxygenase-2 (COX2) genes, which associate to angiogenesis and inflammation.

DC-derived IL-2 can help to maintain Tregs, but also DC could trigger apoptosis to limit excessive immune activation; a failure of this mechanism may lead to autoimmunity.



Calcineurin acts as a NF- κ B signaling repressor in steady-state macrophages which constitutively express NFAT1, NFAT2, NFAT4, and NFAT5. Macrophages either exposed to CNIs or with impaired calcineurin signaling show higher activation of NF- κ B leading to higher levels of IL-12 and TNF α two proinflammatory cytokines. In addition, phagocytes with calcineurin signaling disability become unable to sense bacterial lipopolysaccharide (LPS), compromising host defense.

*NFAT pathway activation in neutrophils is comparable to that of basophils and eosinophils. CNIs reduce degranulation and cytokine release and prolong eosinophil survival. In particular, NFAT impaired-neutrophils cannot destroy *Candida albicans*, although overall antifungal mechanisms are not altered.*

Natural killer (NK) cells are the key guardians of effective immune responses which exert their action by releasing effector cytokines such as TNF α , GM-CSF and IFN γ . NK express NFAT1 and NFAT2 proteins and their stimulation with IL-2 initiates calcineurin/NFAT pathway.(73) NFAT inhibition leads to reduced production of anti-inflammatory cytokines, including IL-10, which is vital for inflammation resolution after infection, this could explain why treated allograft recipients frequently undergo infections, with the increased risk of transplant rejection.

II.6. ONCOGENIC POTENTIAL OF NFAT SIGNALING

Dysregulation of NFAT signaling correlates with malignant transformation and cancer development.(30)

Calcium/CaN/NFAT signaling promotes cell cycle progression and G1/S phase transition in a variety of normal as well as transformed cells. NFAT is a multifunctional integrator factor, implicated in the regulation of growth, survival, migration, invasion and homeostasis of transformed and nontransformed cells and tissues, thereby atypical NFAT signaling is usually associated to overexpression and/or hyperactivity in tumour development and metastasis.(30)(74)(75) NFAT proteins induce transcription of vital regulators such as Cdk6 and cyclin D involved in cell cycle transition stages.(67)



NFAT1 represses the expression of cyclin-dependent kinase 4 (Cdk4, a G0–G1 checkpoint kinase) and of cyclin A2, highlighting its guidance during cell-cycle progression and cell proliferation. Both NFAT1 and NFAT4 deficiency lead to a lymphoproliferative disorder, with decreased threshold for T cell activation independent of costimulation signals, suggesting NFAT1/NFAT4 involvement in TCR responsiveness.(28)

AKT/PKB kinase belongs to PI3K/AKT/m-TOR pathway which has been identified as a repressor of NFAT1 activity. AKT is a proto-oncogene involved in proliferation, growth and survival of a variety of cancer cells. AKT promotes tumor progression enhancing cell survival mechanisms and simultaneously inhibiting cell motility and invasion partly implicating NFAT proteins.(75)

AP1 which is known as NFAT natural activation partner it is also implicated in carcinogenesis gene expression. Depending on NFAT partners and cofactors binding, NFAT proteins could experiment local chromatin acetylation inducing target promoter activation, or interact with HDACs to silence target genes as has been mentioned before.(67)

In resting cancer cells, NFAT proteins follow the same mechanistic pattern than in normal cells.(75) Carcinogenesis characterizes mainly by expressing two NFAT isoforms: NFAT1 and NFAT2, which participate in the regulation of neoplastic transformation and cancer progression.(67)

Cancer type	Family member	Function
B cell lymphomas	NFAT2	Maintaining lymphoma cell survival and counteracting apoptosis by induction of survival factors such as CD40 ligand and BLYS
T-ALL	NFAT1–NFAT4	Constitutive activation of calcineurin leads to NFAT activation
CML	NFAT2	Development of resistance to TKI treatment
Breast cancer	NFAT1 and NFAT5	Control of cancer cell migration and invasion by induction of COX2
Pancreatic cancer	NFAT2	Induction of MYC expression
Prostate cancer	ND	Regulation of cancer cell proliferation
Melanoma	NFAT2 and NFAT4	Induction of COX2
Endometrial cancer	ND	Regulation of IL11 and CXCL8 expression

Figure 35. Ca²⁺/NFAT signaling roles in different types of cancer. (30)



NFAT2 and NFAT1 redundancy has been controversial, some authors talk about redundant and opposite roles in tumorigenesis (30), while others support non-redundant functions during cancer development and progression.(67) However, whether or not NFAT proteins exert redundant or opposite effects in cancer cells might also depend on the cancer genesis and the nuclear transcriptional context given in a cell.(67)

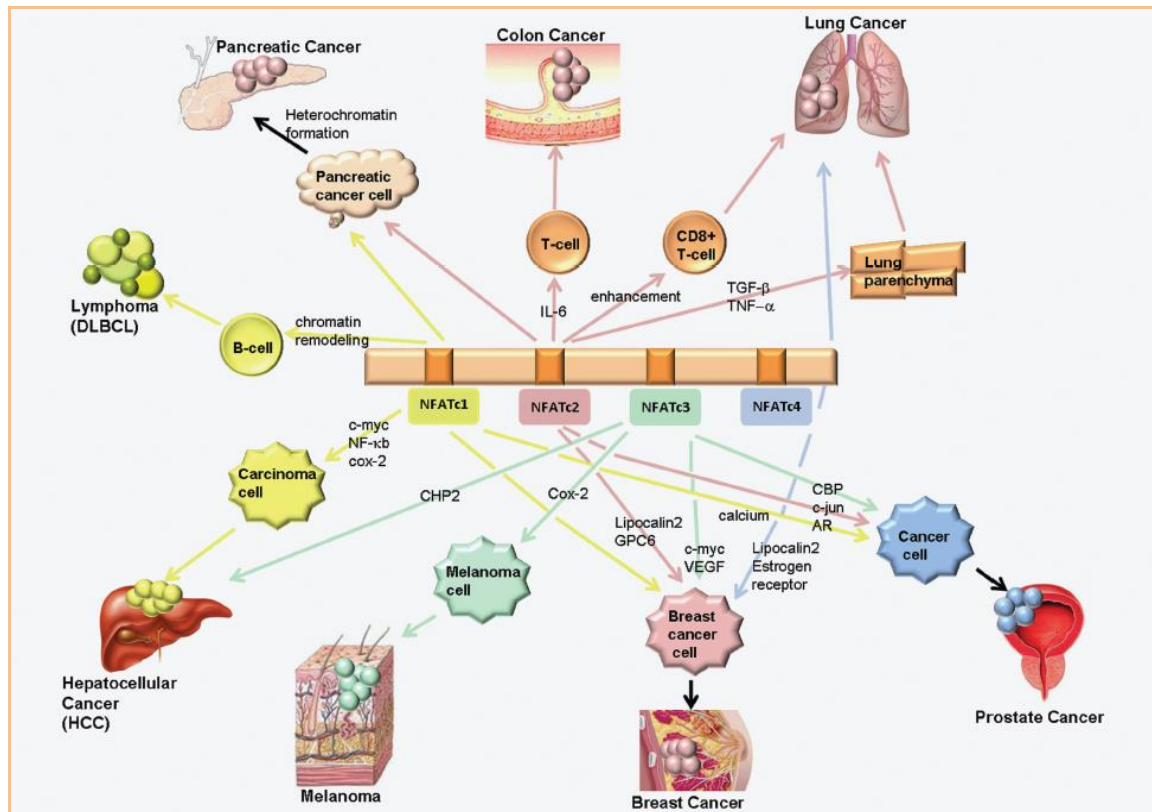

Figure 36. NFAT proteins and cancer development. (74)

NFAT1 inhibition reinforces T cell apoptosis of tumor tissue accentuating NFAT1 role in programmed cell death control.(74) NFAT1/NFAT2 upregulation is characteristic in gastrointestinal malignancies and is an indicator of very poor prognosis.(67)

Calcineurin/NFAT signaling pharmacological antagonists, such as tacrolimus (TAC) and cyclosporine A (CsA) are not appropriate to abolish NFAT proteins oncogenic function because they are unable to discriminate between NFAT isoforms or to perform specifically in tumor cells.(67)



During malignant transformation process, epithelial cells suffer histological changes adopting a mesenchymal phenotype and acquiring the ability to invade connective tissues.(30) Epithelial to mesenchymal transition (EMT) is a key element for tumour cells to metastasize.

Activated NFAT proteins form complexes with key oncogenic proteins to stimulate or upregulate the transcription of master cell cycle regulators and proteins involved in cell survival, migration and angiogenesis impacting in tumor biology: this latter through vascular endothelial growth factor A (VEGFA), tumor cell proliferation through V-myc avian myelocytomatosis viral oncogene homolog (C-MYC) and tumor cell migration through COX-2. NFAT proteins also entail the transcription of genes encoding autotaxin, exonucleotide pyrophosphatase and phosphodiesterase 2 (ENPP2) and induce the expression of VEGFR. VEGFA is secreted into the extracellular matrix by multiple cell types, including tumorigenic cells. Autotaxin secretes lysophosphatidic acid (LPA), a potent mitogenic and motogenic factor for cancer cells, while COX-2 catalyses prostaglandin E2 (PGE2) synthesis in tumor and endothelial cells, leading to increased tumor invasiveness, endothelial cell proliferation and metastatic dissemination.(67) VEGFA and PGE2 are potent stimulators of endothelial cell permeability, proliferation and vessel formation. Both LPA and PGE2 act in an autocrine and paracrine way by binding to their receptors (EDGR and PTGER2) and have growth-factor-like properties, including the stimulation of cell proliferation and chemotaxis.(30)

In endothelial cells VEGFA engagement to its receptors (VEGFR1 and VEGFR2) induces PLC γ pathway and NFAT nuclear translocation, triggering the expression of additional VEGFA and VEGFR, sustained by an autocrine loop. Both VEGFA and PGE2 stimulate endothelial cell proliferation, migration and vessel formation, but VEGFA also promotes the expression of tissue factor an important initiator of blood coagulation and angiogenesis and of colony stimulating factor (CSF), required for endothelial cell differentiation and survival. Angiogenesis during tumor growth develops in an inflammatory environment orchestrated by immune cells during invasion of the damaged or malignant tissue.(74) Inflammatory cytokines in endothelial cells, like IL-1, trigger a program of transcriptional inflammatory genes. VEGF induction is principally mediated by VEGFR2 and VEGFA VEGFA activates NFAT2 in valve endothelial cells, while VEGFR2 inhibits β 1 integrin activation.



NFAT2 isoform has been revealed as an important regulator of lymph angiogenesis due to its interaction with promoting factors [i.e forkhead box protein C2 (FOXC2), podoplanin, prospero-related homeobox gene 1 (PROX1) and VEGFR3].(30) RCANs family members impair NFAT activation in endothelial cells and constitute potent inhibitors of tumour angiogenesis, whereas JNK family kinases also participate avoiding NFAT1 nuclear phosphorylation.(74)

NFAT1 promotes cancer migration and invasion, whereas NFAT5 only migration. Overexpression of NFAT1 and NFAT5 and concomitant expression of $\alpha4\beta6$ integrin on tumour cells can induce Ca^{2+} influx, triggering the activation of NFAT and other transcription factors.(30)

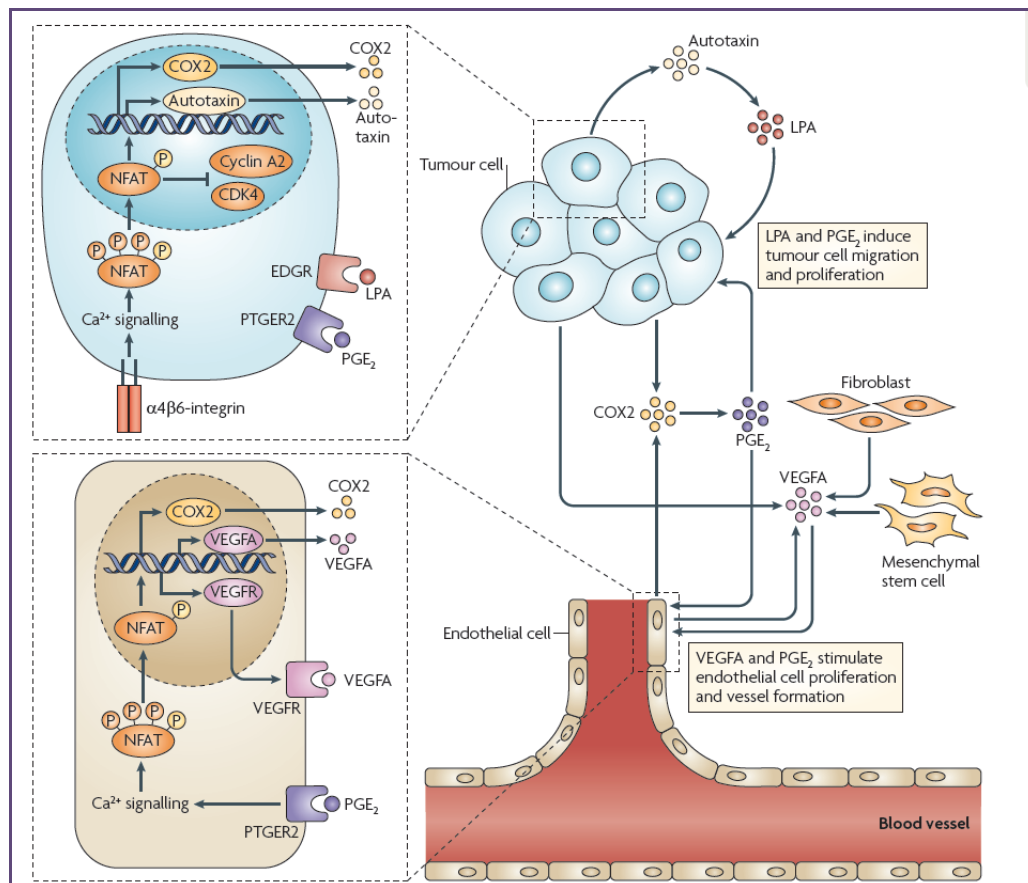

Figure 37. NFAT and cancer pathogenesis.(30)



In this sense, NFAT2 can directly induce C-MYC oncogene transcriptional activation by binding to a consensus promoter sequence (GGAAA) within the serum responsive proximal C-MYC promoter [TGFβ inhibitory element (TIE)], which contains binding sites for different families of transcription factors and is critical for controlling C-MYC expression during G1 phase. TIE reduces C-MYC expression due to TGFβ signaling activation, a key feature of efficient growth control in normal epithelial cells. NFAT binding to this promoter region enhances net histone acetylase activity associated with C-MYC promoter allowing the recruitment of a second Ras-MAPK signaling transcription factor, a member of ETS oncogene family (ELK-1) to facilitate C-MYC expression.

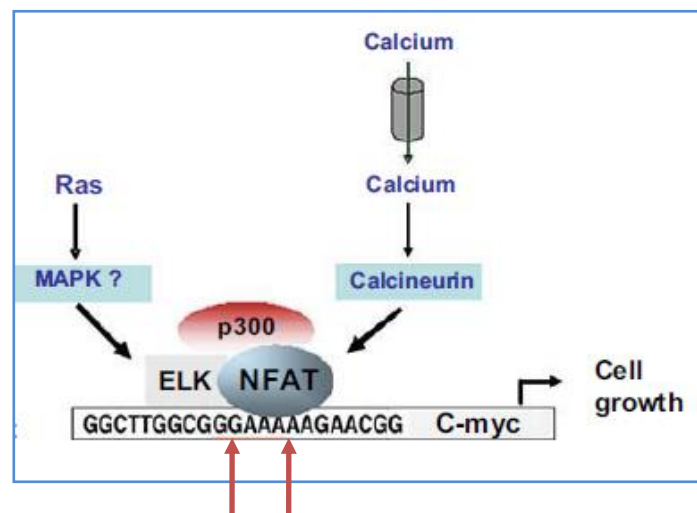
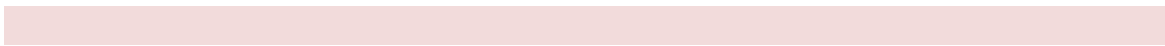

Figure 38. NFAT and cooperative transcription factors signal integration.(67)



III. CALCINEURIN/NFAT REGULATORS

Calcineurin/NFAT pathway is regulated at different levels, in order to guarantee signaling integrity; several redundant and non-redundant mechanisms cooperate synchronically to accomplish this goal.

III.1. NEGATIVE REGULATORS OF T CELL ACTIVATION

NFAT1 and NFAT4 are also repressors of TCR signaling and T cell activation, highlighting NFAT proteins dual effects as a negative and positive regulators of transcription, inhibiting or activating IL-2 depending to which DNA elements NFAT binds.

T cell negative regulators are required to maintain T cells in their dormant state and to end the activation signal. Two groups have been recognized: class I regulators which help to *maintain the quiescent state of unstimulated T cells* [CaN autoinhibitory peptide (AIP); the β subunit of the trimeric serine kinase (I κ B), transcriptional activators such as FOXJ1, FOXO3A] and class II regulators which are transcriptionally induced in response to TCR signaling and act to *limit and cease the activating signal* [calcipressins; I κ B; MAPK phosphatases, which suppress MAPK signaling and thus AP1 nuclear localization components].(70)

TCR activation means that TCR signaling must overcome class I repression in order to proceed to gene transcription. TCR signaling activates at least 3 families of transcription factors (NFAT, NF κ B and AP1) which cooperatively bind to IL-2 enhancer region to promote its transcription. IL-2 is the main cytokine which sustains T cell proliferation and clonal expansion through means of an autocrine signaling loop created by the binding of IL-2 to its high affinity receptor (IL-2R α).

In resting T cells, both NFAT and NF κ B are kept in the cytosol inactive, impaired of nuclear entry due to repressor mechanisms.(70) Calcineurin AIP (at the C terminus of CaNA) binds to the active site of the enzyme and serves as an intramolecular repressor of CaN preventing NFAT dephosphorylation as has previously been mentioned.(70) The nuclear factor NF κ B is also held in the cytosol bound to a family of inhibitor proteins I κ B transcribed by FOXJ1 and FOXO3A activator factors.



Quiescent T cells permanently produce I κ B to prevent NF κ B activation. After TCR activation both transcription factors are inhibited.(70) AP1 is not present in resting T lymphocytes because it is transcriptionally induced only upon TCR signaling.

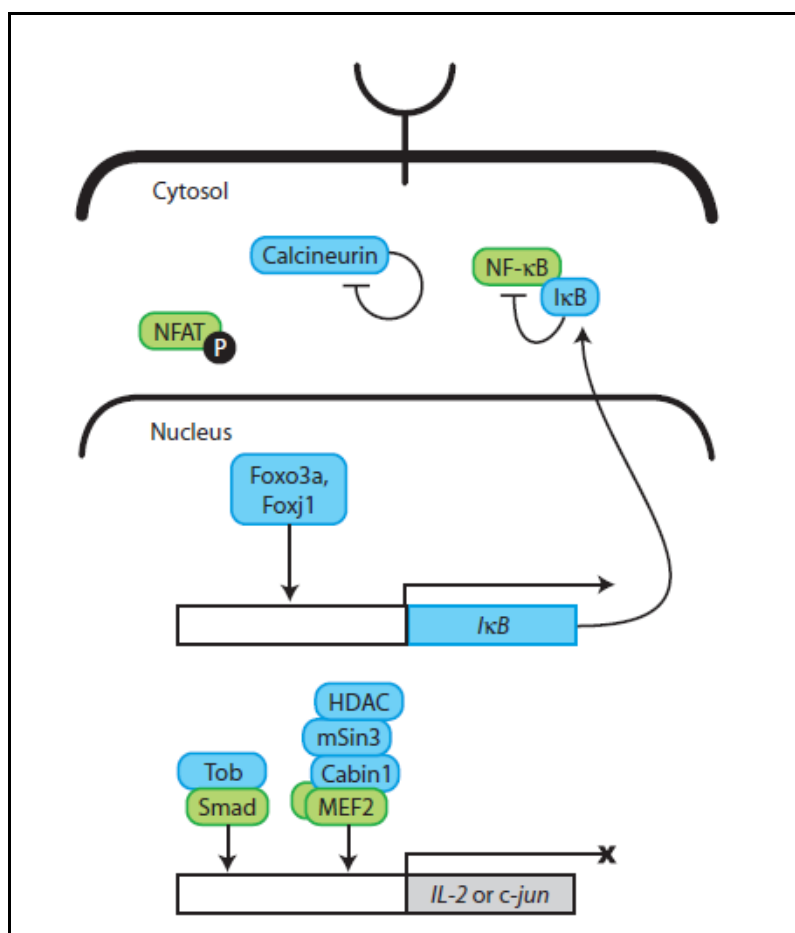

Figure 39. Class I negative regulators of T cell activation.(70)

Calcipressins is a family of RCANs including RCAN1 alias calcipressin 1, CALP, Down syndrome candidate region 1 DSCR1, myocyte-enriched calcineurin-interacting protein 1(MCIP1) Adapt78; RCAN2 also known as DSCR1L1, MCIP2, ZAKI-4, or CALP2; and RCAN3 (DSCR1L2, MCIP3, or CALP3], which have dual roles, acting as calcineurin activity activators or inhibitors according to their subcellular concentrations.

RCAN1 has several splice variants, but only RCAN1.4 is induced by NFAT. RCAN1 increases the threshold for calcineurin activation to insure that calcineurin target genes will be expressed only upon a given strength of TCR stimulation.(32)



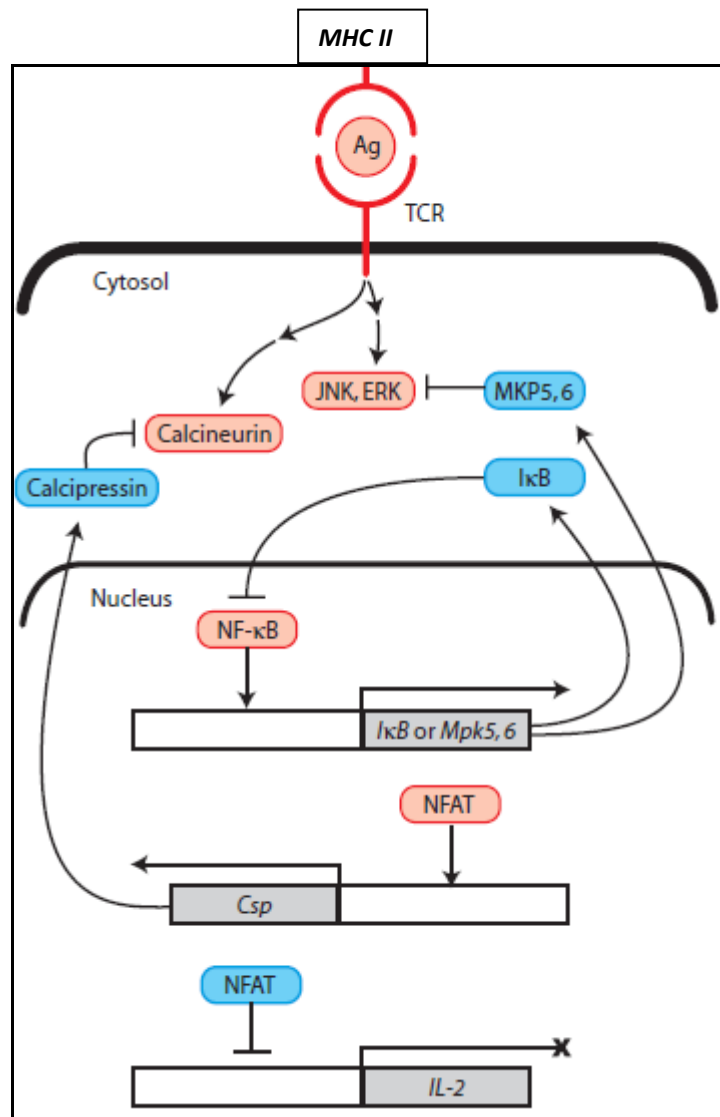

Figure 40. Class II repressors: calcipressin, NFAT1, NFAT4, IκB and Mitogen-activated protein kinase phosphatases.(70)

An incoherent regulation switch controls RCAN1 and it is structurally similar to the feedforward loop that induces a biphasic response. This mechanism induce a fast activation followed by a delayed inhibition of the resulting response.(76)

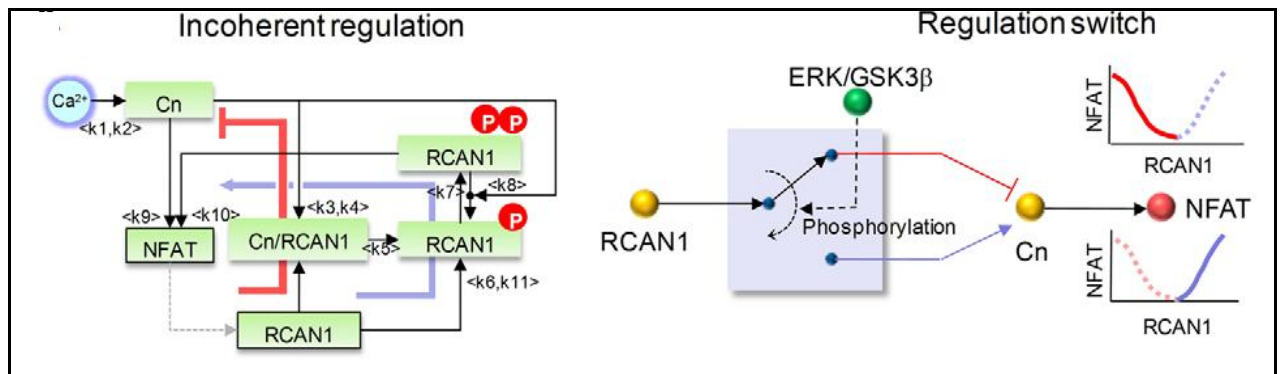

Figure 41. An incoherent regulation switch coordinates RCAN1 function.(76)

RCAN1 functional role changes in a dose dependent manner: RCAN1 acts as an inhibitor when its levels are low, but as a promoter when the levels are high.(76) This property involve downregulation through RCAN1 binding competitively to calcineurin and upregulation through sequential phosphorylation of RCAN1. Non-phosphorylated RCAN1 bound to CaN inhibits its activity while the sequential phosphorylation of RCAN1 promotes calcineurin/NFAT signaling. Upon phosphorylation at Ser112 by ERK5 RCAN1 dissociates from calcineurin re-establishing calcineurin/NFAT signaling. In the cytosol GSK3 β could further phosphorylate RCAN1 at Ser108 in cooperation with ERK, but calcineurin selectively dephosphorylate this site. In this regulation switch, crosstalk signals provided by ERK and GSK3 β command the negative regulation by RCAN1 to a positive regulation, contributing to the induction of biphasic response. RCAN1 levels progressive increases incite nuclear NFAT biphasic response ('concave-up') explaining why RCAN1 function changes under different experimental conditions.

Apparently RCAN1 highly phosphorylated will translocate to the nucleus together with NFAT after deacetylation by means of HDAC3 (ubiquitously expressed Class I histone deacetylase with variable C terminus). HDAC3 also stabilizes the protein in a dose dependent manner.(77) HDAC3 is present in the nucleus, cytoplasm, and at the plasma membrane, and its roles do not overlap with other of HDAC members. HDAC3-mediated RCAN1 nuclear translocation and RCAN1 deacetylation occur independently. Transforming growth factor beta-activated kinase 1 (TAK1) phosphorylate RCAN1 also and suppress its inhibitory effect on calcineurin activity.(77)



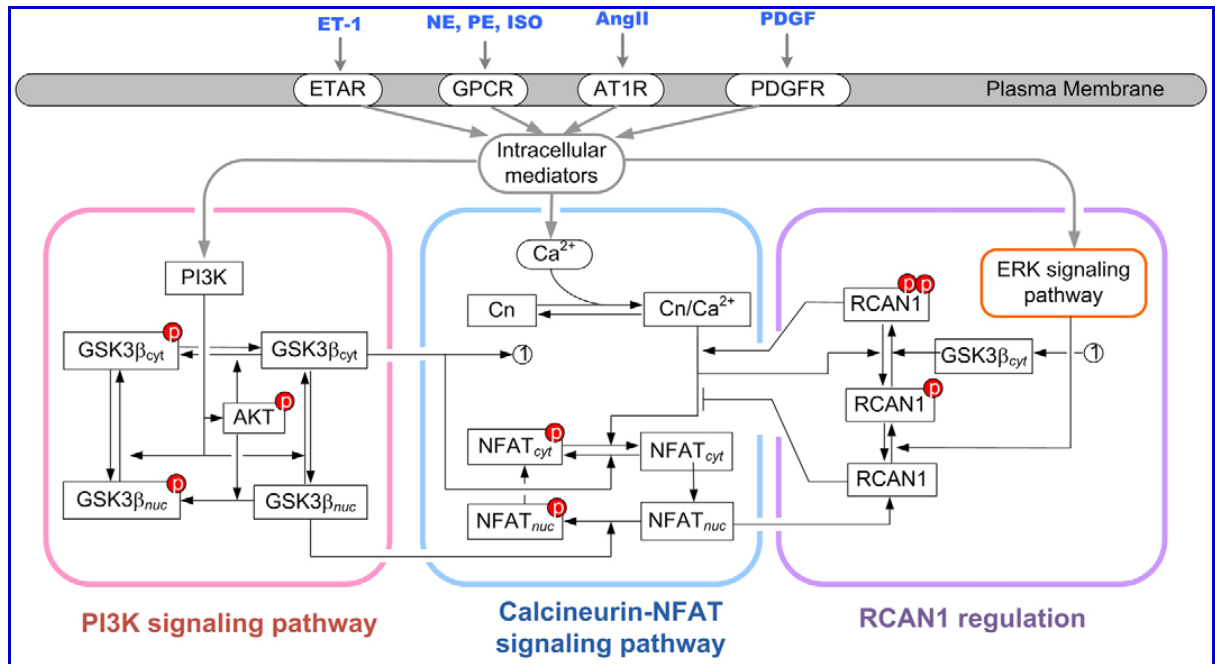

Figure 42. Diagram of the calcineurin/NFAT signaling network.(76)

Full activation of nuclear NFAT requires crosstalk signals from both ERK and GSK3 β (phosphorylates nuclear NFAT), suggesting that such crosstalk are also committed to the induction of NFAT nuclear shuttling.(76) The threshold at which nuclear NFAT levels start to increase are higher for ERK than for PI3K and such difference might be due to their distinct roles in calcineurin/NFAT pathway: ERK re-establishes calcineurin activity by releasing RCAN1 from the calcineurin complex, whereas phosphorylated NFAT by GSK3 β in the cytosol binds to 14-3-3 protein reinforcing its inactivation. (76)

Two CaMK play important and opposing roles during TCR signaling: calmoduline dependent protein kinase II (CaMKII) is a negative regulator while CaMKIV is an enhancer.

CAMKII signaling is quite complex because the large number of isoforms with different cellular localization. CAMKII downregulates TCR mediated cytokine production (i.e. IL-2) inhibiting CaN phosphatase activity through phosphorylation directly.(32) CaN phosphorylation occur at Ser197 residue located in the C-terminal boundary of the recognized Ca²⁺/CaM binding domain. This phosphorylation site is not available when Ca²⁺/CaM are bound to calcineurin.



Four types of CaM binding proteins are implicated in calcium signaling transmission from the cytosol to a nuclear transcriptional output: CaN; CaM-dependent protein serine-threonine kinases; transcription corepressors Cabin1 and HDAC II. The intense cross-talking between these proteins determines in the end transcription fate.(32)

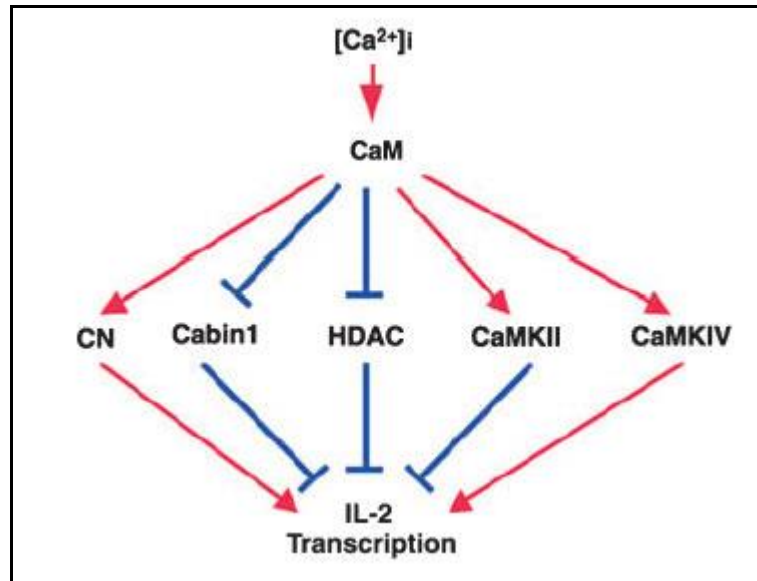

Figure 43. Calmodulin binding signal transducers in T cells.(32)



III.2. ENDOGENOUS REGULATORS OF CALCINEURIN

Calcineurin activity is controlled not only by calcium and calmodulin but also by several endogenous inhibitors such as calcineurin-binding protein 1 (CABIN1; CAIN), Carabin, CAMKII, RCAN1 and A-kinase anchor protein 79 (AKAP79) (30)(32).

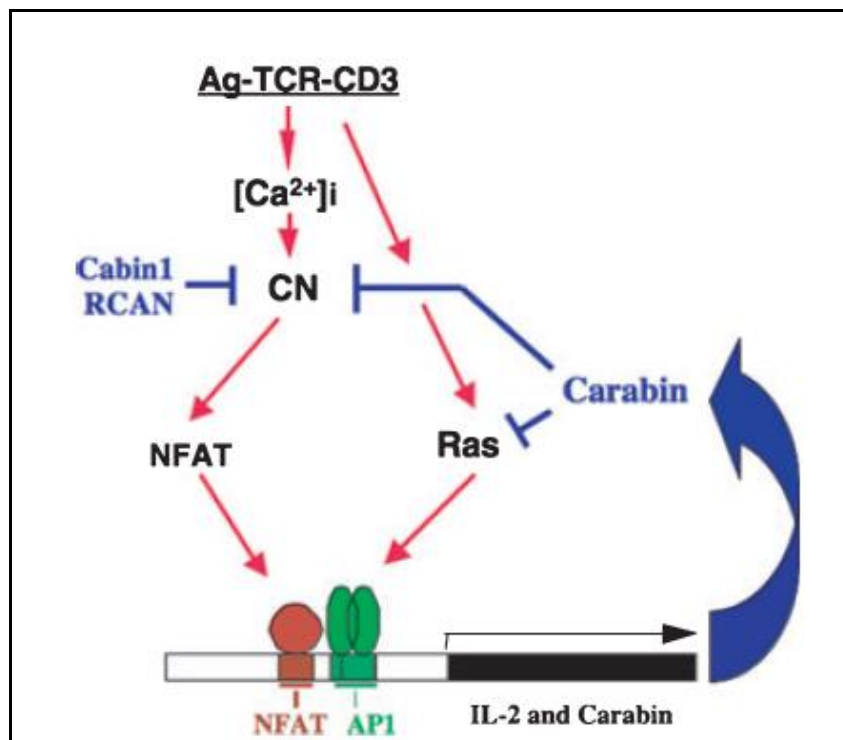

Figure 44. Calcineurin protein inhibitors and CaN/NFAT axis downregulation.(32)

Cabin1 inhibits calcineurin activity by binding to PxlxIT-like conserved motif. In resting T cells Cabin1 is hypophosphorylated, but in response to PKC activation by calcium signaling, it becomes hyperphosphorylated increasing its affinity for calcineurin and impairing T cell activation. Cabin1 competes with CaM for binding to MADS box region of MEF2 proteins by means of PxlxIT-like motif named KPVIET.(48)(78)

Cabin1 is also a scaffold protein for calcineurin and MEF2 (a calcium-dependent modulator involved in cell division, differentiation and death). Cabin1 and class II histone deacetylases HDACs together with MEF2 transcription factor and the transcriptional coactivator p300 regulate cytokine gene transcription in a calcium dependent manner. It is suggested that one of the functions of Cabin1 may be to set a higher threshold for the activation of calcineurin, maintaining CaN in an inactive state in resting T cells.(32)



MEF2 is constitutively bound to DNA in the nucleus despite of T cell activation status. MEF2 constitutes an activator/repressor complex. In resting cells it works as a scaffold protein associated with Cabin1 and recruiting class I HDACs and a histone methyltransferase or class II HDACs which silence IL-2 promoter.(32) Its main role is to remodel chromatin in IL-2 promoter, while NFAT and other transcription factors hold IL-2 basal machinery recruitment towards IL-2 promoter. MEF2 stands up as a key factor not related to NFAT implicated in TCR mediated cytokine production.(32)(70)

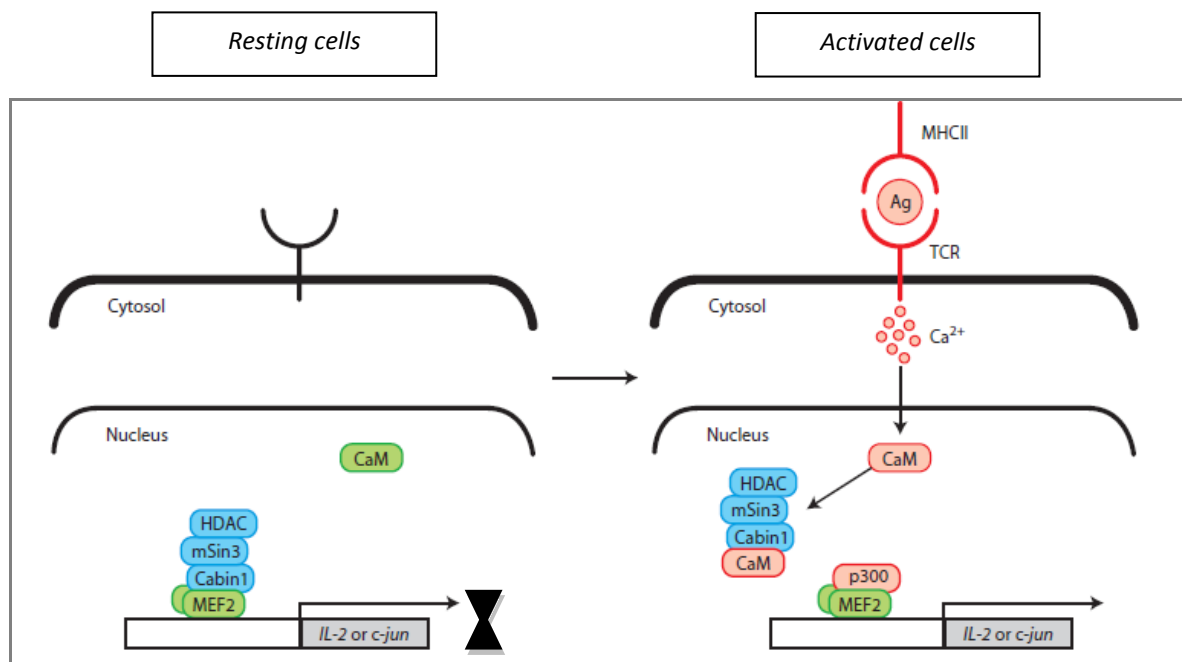

Figure 45. MEF2 complex involvement in the repression and activation of IL-2 promoter.(32)

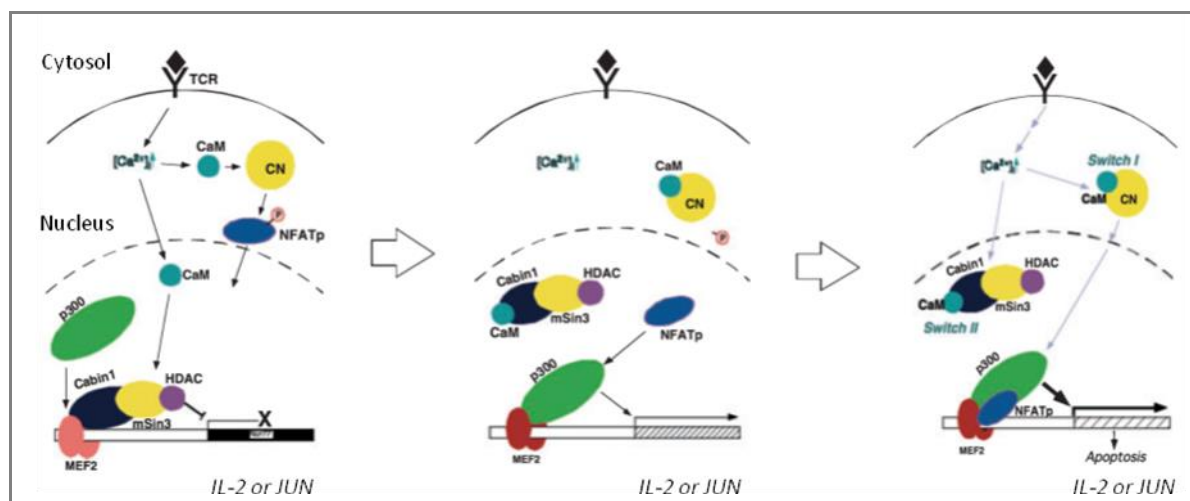

Figure 46. Signal integration between MEF2:Cabin1:p300 and CaN/NFAT signaling.(32)



Upon an increase in $[Ca^{2+}]_i$ during TCR signaling, nuclear CaM binds to Cabin1 and class II HDACs releasing MEF2 from the complex, and thereby enabling its interaction with the transcriptional coactivator p300. Cabin 1 and class II HDACs might contain CaM binding domains for MEF2 mutually exclusive. MEF2 can also play as transcriptional activator by the action of a calcium dynamic switch step from HDAC/methyltransferase to histone acetyltransferase (HAT).(32)

MEF2 participates in the transcription of several early genes including Nur77 and c-JUN.

In T cells Carabin prevents the phosphorylation and activation of ERKs without influencing the activity of JNK or p38. Carabin is a negative regulator of the CaN/NFAT signaling pathway, repressing also the Ras pathway, attenuating TCR signaling and T cell activation.(79). In resting T cells, Carabin expression is low, but upon TCR activation its expression becomes upregulated.(32)(79)

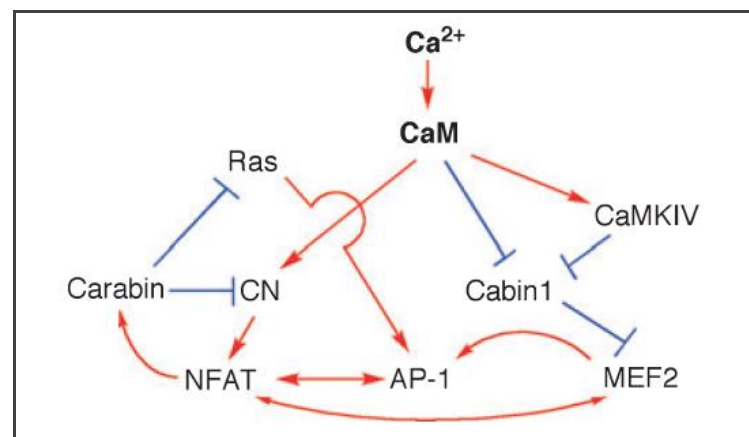

Figure 47. Crosstalk among calcium signal transducers in T cells. (32)

A-kinase-anchoring scaffold proteins binds to CaNA at the same surface of calcineurin as the PxIXIT recognition peptide of NFAT, though more strongly but allowing CaN rapid dissociation of for downstream physiological signaling transduction.(80)



III.3. OTHER REGULATORS OF THE CALCINEURIN/NFAT PATHWAY

III.3.1. Tob-SMAD Complex

In T cells Tob family proteins express in quiescent or anergic cells. They downregulate cell proliferation and cell cycle progression genes, such as cyclin A, E and cyclin-dependent kinase 2 (Cdk2), but they upregulate cell cycle repressor p27^{kip1}. Tob expression is driven by the lung Kuppel like transcription factor (LKLF).

Tob inhibits IL-2 transcription not by direct binding to DNA, but affecting DNA binding and transactivation activity of SMAD proteins. Tob-SMAD2/4 complex fixes to a -105bp negative regulatory element on the IL-2 promoter to silence it by chromatin remodeling prior HDAC I recruiting.(70)

III.3.2. DREAM Transcriptional repressor

In T lymphocytes three distinct Ca²⁺ signaling modules are concomitantly implicated to cytokine gene expression control: NFAT activator, MEF2 repressor/activator and Downstream regulatory element antagonist modulator (DREAM, also named calsenilin/KCHIP-3 K⁺ channel interacting protein 3) repressor. Each calcium-dependent module may work alone to inhibit cytokine promoters basal expression, however under stimulated circumstances they may act coordinated.

DREAM is a calcium binding protein that in non-stimulated conditions represses DNA transcription of its target genes by nuclear binding to DRE (downstream regulatory element) sites; in addition, MEF2:Cabin1 interaction recruits a corepressor complex containing HDAC. DRE-dependent transcription derepression is controlled by PKA or PI3 kinase activation.(81) However, after TCR stimulation and [Ca²⁺]_i increase, DREAM binding directly to Ca²⁺ experiences a conformational change through which DREAM EF-hand domain releases DREAM from the DRE sequences, provoking gene derepression (IL-2, IL-4, IFN γ). Figure 47 illustrates this mechanism: (i). EF DREAM works as a negative regulator of lymphocyte proliferation and thereby in cytokine gene expression, by direct binding of DREAM to the proximal promoters of cytokine genes in a calcium dependent manner. Ca²⁺/CaM binding activates CaN, resulting in NFAT dephosphorylation, which translocate to the nucleus to activate cytokine transcription in cooperation with AP1



(ii). Ca^{2+} /CaM binding to Cabin1 releases MEF2 to phosphorylation by MAPKs and p300 recruitment, enabling transcription (iii). Ca^{2+} /CaMKIV phosphorylates Cabin1 creating a docking site for 14-3-3 protein and exporting nuclear Cabin1 (iv).

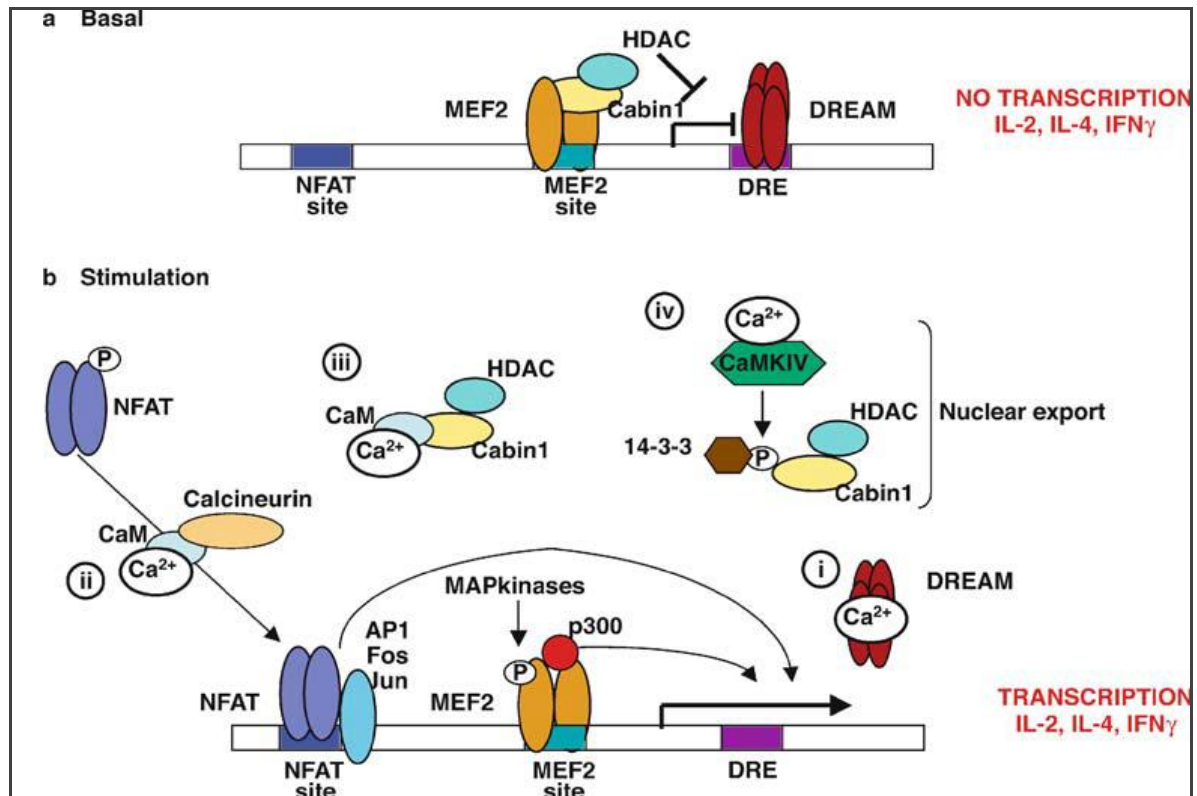

Figure 48. Calcium-dependent transcription of cytokines

DREAM interacts with Kv4 potassium channels and presenilins committed to channel gating regulation and Ca^{2+} release from the ER.

DREAM is also involved in cAMP dependent derepression through means of specific protein–protein interaction between DREAM and α - or ϵ -CREM (cAMP-response element modulator).



III.4. EXTRINSIC INHIBITORS OF CALCINEURIN/NFAT SIGNALING: ANTICALCINEURIN DRUGS

Inhibition of CaN:NFAT docking could develop some undesired side effects than enzymatic activity cessation.(34)

The binary complex: cyclophilin: CsA or FKBP12:TAC, binds to the composite surface of calcineurin A (CaNA) and CaNB to form a ternary complex. Both complexes bind to the same region of CaN (LxVP) and share main recognition elements. CaNB N-terminal domain flexibility may impact on CaN phosphatase activity regulation.

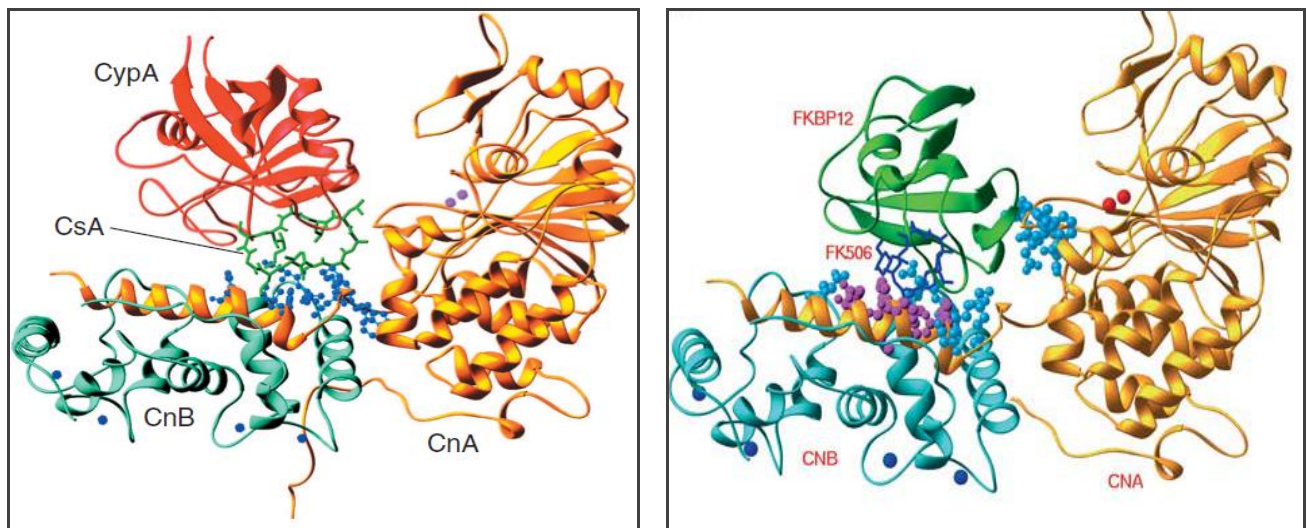

Figure 49. CsA/TAC- Immunophilin- Calcineurin complex.(57)

Structural analyses revealed that differently from the AIP, these drug;immunophilin complexes do not fix on the active site, but instead bind in a pocket $\sim 30\text{\AA}$ away at the base of the helical arm of calcineurin catalytic subunit that binds the regulatory subunit CaNB. The complex is hold in a hydrophobic groove in contact with both subunits, at a dedicated domain unique to CaN; this intimate contact contributes to the specificity of the interaction. Hydrogen bond and hydrophobic interactions establish a conformational constraint on the catalytic residue of CaN (Arg 122) by which its activity is regulated. Moreover, complex sheer sizes in front of calcineurin active site serve as an allosteric impairment for protein substrates to reach the active site.(32) CaN activity is regulated via substrate approach rather than through active site inhibition.



CNIs binding to immunophilin:CaN dimer stabilizes the complex conferring resistance to proteolytic cleavage and inhibits its phosphatase activity and biological function.(50) Another interesting feature of the structure is the lower degree of conservation of hydrogen bonds. Of the 9 hydrogen bonds between CyPA:CsA:CaN, only 4 are common to FKBP:TAC, highlighting the composite capacity for binding to a variety of protein substrates.

CaNB binding helix of CaNA subunit (BBH) embeds in CaNB forming a composite site together with CaNB for allowing CyPA:drug complex binding.(57)

CaN active site is 9–10 residues C-terminal to LxVP recognition sequence. Breaking down of CaN and LxVP motifs interaction within substrates is enough for dephosphorylating impairment of LxVP-containing substrates, and to explain the molecular mechanism of these drugs. Furthermore, TAC and CsA antagonism suggests that each substrate contains at least one LxVP motif and this interaction is essential for substrate dephosphorylation.(49)

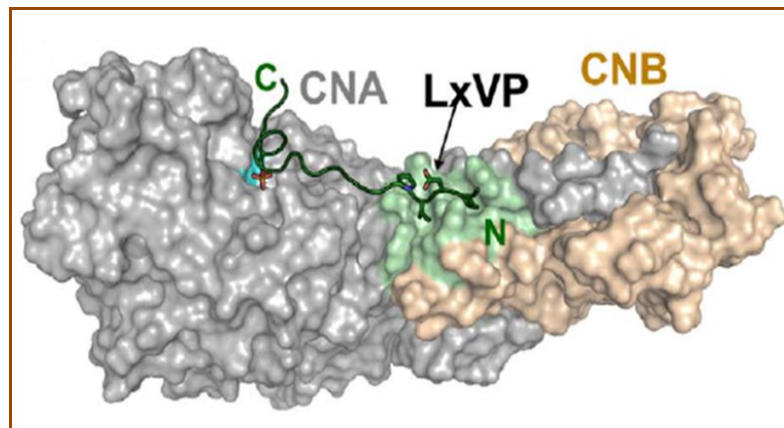

Figure 50. LxVP motif in Calcineurin.(49)

Interestingly, calcineurin inhibitors end T cell anergy induction program, preventing lymphocyte tolerance.(48) Moreover, they are not appropriate to abolish NFAT proteins oncogenic function because they are unable to discriminate between NFAT isoforms or to perform specifically in tumor cells.(67)



IV. INTERLEUKIN 2

IV.1. INTERLEUKIN 2 SIGNALING

Interleukin 2 (IL-2) is one of NFAT-dependent genes and it is necessary to maintain effective immune response, lymphocyte differentiation and homeostasis. IL-2 is involved in the activation of helper T cells, cytotoxic T cells, natural killer cells, B cells, and macrophages.(82) IL-2 promoter/enhancer induction requires to trespass a threshold level provided by one or both NFAT factors (NFAT1/2), whereas below a certain value (i.e. provided only by NFAT4 which is less expressed in T cells) the promoter/enhancer remains inoperative.(66)

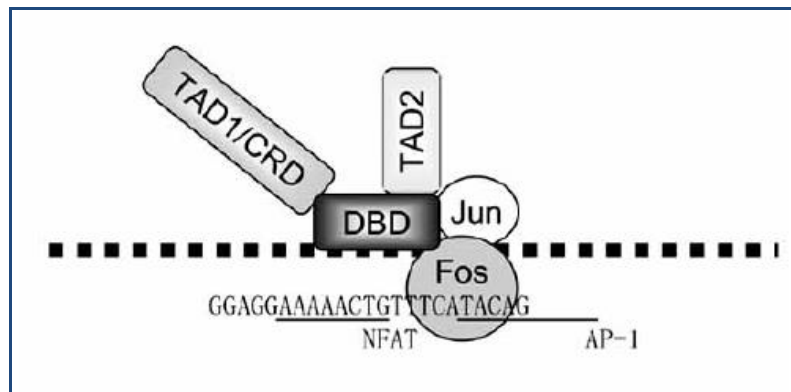

Figure 51. NFAT partners in IL-2 transcription.(69)

IL-2 production is regulated by distinct mechanisms, including *IL2* gene repression via B lymphocyte-induced maturation protein 1 (BLIMP1) transcription factor, which is first activated by IL-2 but then inhibits IL-2 production, by a negative feedback mechanism. Other factors control *IL2* transcription such as: nuclear factor 90 (NF90), NF45, NR2F6, runt-related transcription factor 1 (Runx1), Runx and Tob-SMAD2/4 complex.

Runx3 and Runx1 proteins cooperate with NFkB and with NFAT/AP1 on the *IL-2* promoter to induce IL-2 transcription, whereas NFAT/FOXP3 and the NFAT auto-regulatory loop on the NFAT2 promoter repress *IL-2* transcription.

If nuclear receptor subfamily 2, group F, member 6 (NR2F6) is absent, IL2 promoter is derepressed increasing its transcription.(83)

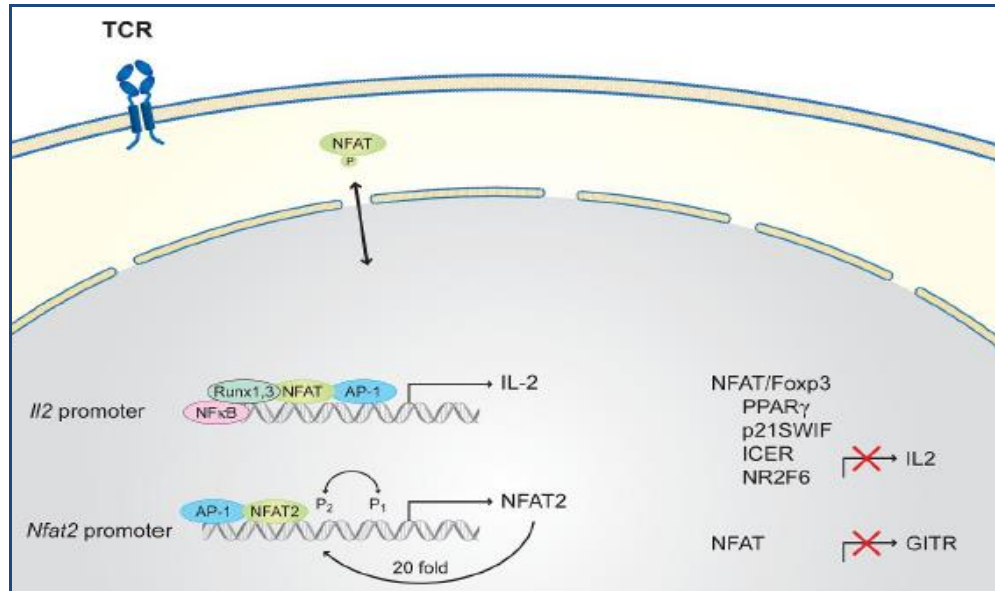

Figure 52. IL-2 transcription during T cell activation.(83)

Furthermore, IL-2 is a key element for the maintenance of Tregs cells functionality (and thus peripheral immune tolerance), for the differentiation of CD4⁺ and CD8⁺ T cells into effector T cell subsets following antigen-mediated activation, and for optimizing both effector T cell generation and differentiation into memory cells.(84)

In organ transplantation one of the purposes of anticalcineurin drugs treatment is to reduce IL-2 production, in order to minimize inflammation and graft rejection. Contrary to CsA, tacrolimus inhibits IL-4 mRNA expression (Th2 response), but however, it does not upregulate TGF β , as CsA does, pointing out the differences between both CNISs in the inhibition of cytokine expression.(84)

Under resting conditions, IL-2 is principally produced by activated CD4⁺ T helper cells via MHC class II complexes in lymph nodes, and, to a lesser extent, by CD8⁺ T cells, natural killer and natural killer T (NKT) cells. IL-2 synthesis by CD8⁺ T cells is less than CD4⁺ and CD8⁺ responses often require CD4⁺ assistance.



IL-2 is principally produced by activated T cells in secondary lymphoid organs, where it is consumed by CD4⁺ and CD8⁺ subsets and other CD25⁺ T cells, including Tregs.

During immune response activated CD4⁺ and CD8⁺ T cells in lymph nodes increase IL-2 consumption by CD25⁺ effector T cells and Tregs. In lymph nodes DCs express CD25 which have the ability to bind to T cell-or DC-derived IL-2 for trans-presentation to adjacent CD25^{low}CD4⁺ effector T cells (maybe CD8⁺ also) promptly during T cell activation before higher levels of CD25 are reached.

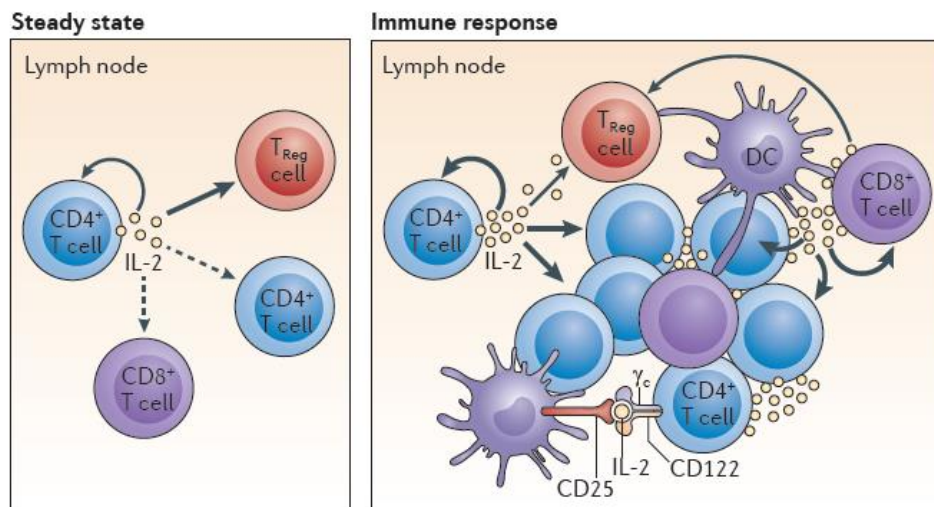

Figure 53. IL-2 homeostasis in resting and stimulation cells.(85)

IL-2 biologic effects are mediated via the IL-2 surface receptor, which is composed of 3 subunits: the α -chain (IL-2R α , CD25), the β -chain (IL-2R β , CD122), and the common cytokine receptor γ -chain (γ c-chain, CD132).(82)(85) IL-2 expression induces IL-2R synthesis, and both are essential for efficient immune response, T cell proliferation and progression from the G0 to G1 phase.(86) IL-2 exerts its action on cells by the expression of the high-affinity trimeric receptor or the low-affinity dimeric receptor, comprised of CD122 and γ c; due to its weak affinity for IL-2 this dimeric receptor requires high levels of expression to attain IL-2 responsiveness.

CD25's role is to increase receptor's affinity for its ligand by 10 to 100-fold.



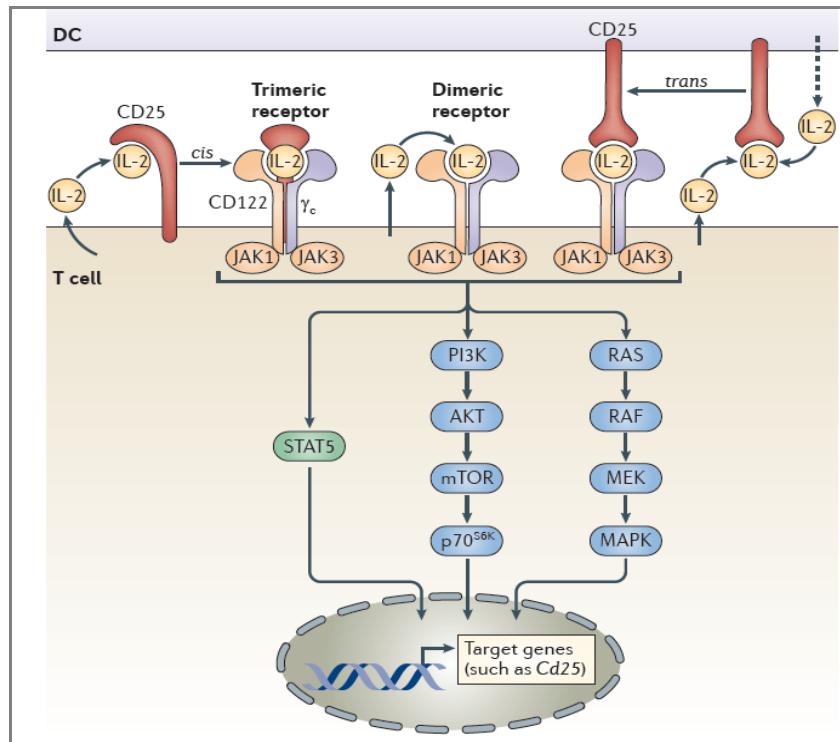

Figure 54. Schematic diagram of IL-2 and IL-2 R.(85)

IV.2. IL-2 SIGNALS CONTROL CD4⁺ T CELL SUBSETS

IL-2 is also critical for Tregs cell homeostasis. Tregs develop in the thymus through contact with self-peptide–MHC class II complexes and express FOXP3. IL-2 signals increase CD25 expression and amplify the suppressive capacity of Tregs cells maintaining FOXP3 at high concentration. However Tregs do not produce by themselves significant amounts of IL-2, instead they depend on IL-2 supply by other cells. Tregs express high levels of CD25 on their surface, but they capture IL-2 from the proximal environment, limiting IL-2 systemic levels *in vivo*.

If IL-2 signaling is inhibited Tregs cells decreases, whereas Th17 cells increase, leading to enhanced susceptibility to autoimmune disease and inflammatory disorders, explaining the importance of IL-2 signals for the reciprocal balance between Th17 cells and FOXP3⁺ Tregs cells.(85)

IL-2 signaling via STAT5 influences T helper (CD4⁺ activated) cell subsets differentiation (including Th1, Th2 and Th17 cells) and Tregs homeostasis.

Polarization towards the Th1 cell phenotype depends on IL-12/STAT4/T-bet signals, resulting in enhanced IFN γ output, by the coproduction of IL-2 by the responding T cells.

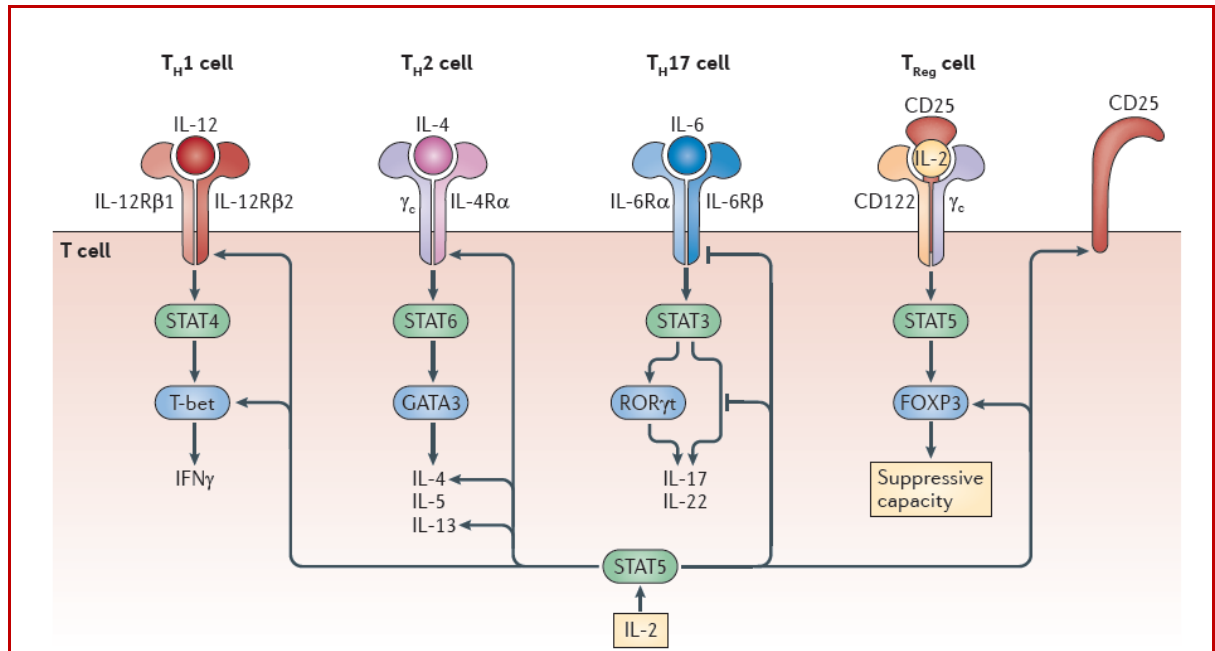

Figure 55. IL-2 signals in the differentiation and survival of CD4⁺ Th and Tregs cells.(85)

Th2 cell differentiation also requires IL-2 stimulation. Th2 cells express high levels of GATA3, which synthesizes important quantities of IL-4, IL-5 and IL-13. IL-2 signaling in Th2 cells upregulates IL-4R α expression and maintains *IL4* gene locus accessible during the later stages of Th2 cell differentiation.(85)

Th17 cells generation depends on IL-6 and TGF β signals and unlike Th1 and Th2 cells, IL-2 inhibits cell polarization. CD4⁺ activated T cells exposed to IL-2 reduce IL-6-mediated STAT3 activation, required for Th17 cells development by decreasing IL-6R β /IL-6R expression. IL-2-mediated STAT5 activation competes for the same sites of IL17 locus with STAT3. At the end STAT3 and STAT5 balance determines the extent of Th17 cell response. Under Th17 cell-polarizing conditions, Tregs cells sustain Th17 cell survival and function (notably IL-17 and IL-22 production), perhaps through IL-2 consumption.(85)



IV.3. IL-2 OPTIMIZES CD8⁺ T CELL RESPONSES

IL-2 signaling influences CD8⁺ T cells during all stages of an immune response, including primary expansion, contraction, memory generation and secondary expansion.

Besides CD4⁺ T helper cells regulation of CD8⁺ responses, CD8⁺ T cells depend on autocrine IL-2 production. CD8⁺ naïve T cells differentiation is affected by the strength and duration of IL-2 signals during a primary and secondary immune response.(85)

Tregs cells can modulate CD8⁺ T cell responses restraining IL-2 production, reducing transient effector CD8⁺ T cells in favor of memory T cell induction. Naïve CD8⁺ T cells could also be stimulated by IL-2 through the low-affinity dimmeric IL-2R. For these reasons high concentrations of IL-2 (or IL-15) promote strong and rapid proliferation of CD8⁺ T cells towards the generation of effector-like T cells MHC I-dependent, contrary to homeostatic expansion, which is slow. High levels of IL-2 can stimulate naïve and resting memory CD8⁺ T and NK cells. Autocrine and paracrine IL-2 signals potentiate the expansion and differentiation of cells expressing the trimeric IL-2R.(85)



IV.4. IL-2 HOMEOSTASIS

IL-2 effect on T cell homeostasis depends on IL-2 production/consumption rate in the steady state.

IV.4.1. FOXP3 Transcription factor: a Negative regulator of IL-2

Both AP1 and FOXP2 bind to the same DNA region adjacent to NFAT on a composite NFAT:AP1 element of the IL2 promoter, interacting through non-overlapping residues.

IV.4.2. SIVA gene: Negative regulator of IL-2

SIVA is a pro-apoptotic gene expressed in several tissues, including CD4⁺ T cells, which is also a negative regulator of IL-2 gene expression during T cell activation; SIVA exerts its action via NFkB inhibition, while FOXP3 puts down NFkB and NFAT activity.(87)

IV.5. INTRACELLULAR IL-2 EXPRESSION AND ACUTE REJECTION

IL-2 levels in serum or plasma are not accurate to diagnose rejection, however good correlations were reported from IL-2 expression of lymphocytes infiltrating liver graft tissue during acute rejection, thus intracellular IL-2 expression in PBMC may reflect CNI effect in graft recipients.(13) Previous reports have shown that patients who underwent to acute rejection exceed 25% IL-2⁺CD8⁺ T cell subset. Furthermore, patients who developed acute rejection had since pretransplant condition higher percentages of IL-2⁺CD8⁺ expression.(13)



V. INTERLEUKIN 2 α CHAIN RECEPTOR, Surface Marker of Activated T Cells

V.1. CD25 SIGNALING

Calcineurin also controls T cell surface receptors expression, which appear after T cell activation, and constitute important regulators of the immune response.

In T cells, IL-2R β and γ_c are constitutively present at the cell surface while IL-2R α only appears upon antigen activation and stabilizes binding. In normal circulating lymphocytes, the IL-2 receptor α is expressed at low levels, but on activated T cells is rapidly transcribed.(82) After TCR activation high levels of the trimeric IL-2R are expressed by CD4 $^+$ and CD8 $^+$ T. On naïve CD4 $^+$ T cells, low affinity receptor is scarce, while in naïve CD8 $^+$ T cells and memory CD4 $^+$ T cells is important and yet CD25 (IL-2R α) is very high on memory CD8 $^+$ T cells and NK cells.(85) However, receptor signaling is committed to cytoplasmic tails of the other two components. Once IL-2 binds to CD122 and γ_c , triggers transcription of the target genes (i.e. CD25) via three major pathways the MAPK cascade, the JAK-STAT pathway and the PI3K signaling.(85) IL-2 binding to CD25 causes a conformational change on IL-2, which is followed by the recruitment of CD122 and finally γ_c . Under these conditions the IL-2:IL-2R complex is rapidly internalized, IL-2, CD122 and γ_c are thereafter degraded; while CD25 is recycled to the cell surface.(85)

In T cells CD25 expression is controlled by TCR stimulation and also by IL-2 contact, through a positive feedback loop that involves the binding of signal transducer and activator of transcription 5 (STAT5) to the CD25 gene locus.(83) IL-2 and IL-2R α interactions induce STAT5 phosphorylation where the costimulatory signal is CCR5, which also mobilizes intracellular Ca $^{2+}$.(62)(83)

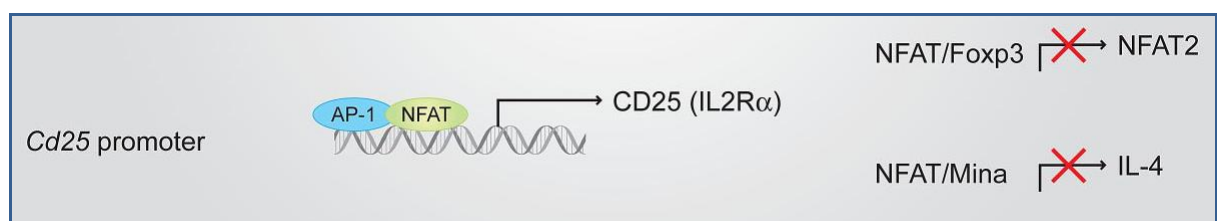

Figure 56. CD25 transcription in T cells. (83)



Sustained IL-2R α expression depends on IL-2 stimulation. IL-2- responsive enhancer contains two STAT5 (STAT 5a and 5b) binding sites and an E1f-1 binding site; either STAT isoform can upregulate IL-2R α , but STAT5 DNA binding activity is not enough for activation. IL-2R β segment between residues 392 and 510 is also required for IL-2R α expression; which triggers an independent signal transduction pathway that synergizes with activated STAT5.(88)

Transmembrane cytokine receptors expression are induced by cytokines by dimerization of their signaling subunits, which are not covalently associated with tyrosine kinases of the janus kinases (JAK) family 3. JAK kinases activation recruits and phosphorylates STAT factors, which then dissociate from their receptors to activate transcription in the nucleus. Signal initiating kinases JAK1 and JAK3 and STAT5 activation is accomplished by IL-2 and IL-15 receptors, pointing their overlapping functions.(89) Both cytokines differ in the third subunit: IL-2R α and IL-15R α . IL-15 supports CD8⁺ memory T cells survival, while IL-2 also is involved in cell death induction and the maintenance of peripheral Tregs. Expression of IL-2R α , IL-2 and IFN γ are augmented within 4h after stimulating signals are triggered.(89)

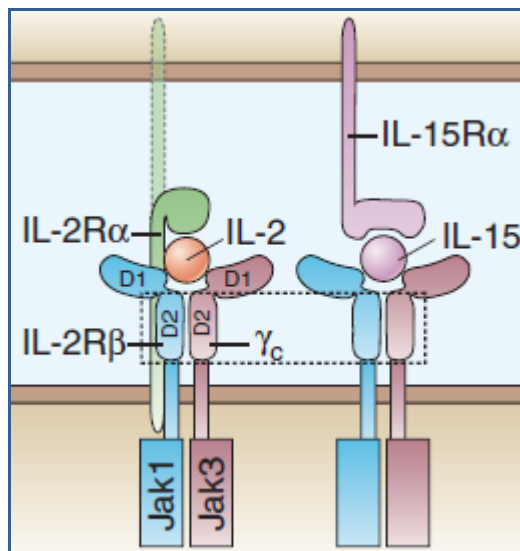

Figure 57. Signaling complexes formed by IL-2 and IL-15.(89) Dotted green line indicates the possible trans presentation of IL-2. Dotted box points regions of similarity in structure and organization of the D2 domains with JAK1 and JAK3.



V.2. IL-2R α TRANSCRIPTIONAL REGULATION

Of the three subunits of IL-2R, only α contains an IL-2 response element relative to the start transcription position. IL-2R α promoter has 4 positive regulatory regions (PRRs I to IV), two of which are for STAT dimmers binding.(90) PRR I and PRR II are required for mitogenic stimulation of the IL-2R α gene, while PRR III and IV are IL-2 response elements.

PRR I has a binding site for NF κ B1, c-REL, and serum responsive factor (SRF); PRR II binds the lymphoid/myeloid-specific ETS family protein (ELF-1), and the high mobility group proteins [HMG-I(Y)], and PRR III can bind to STAT5 proteins, Elf-1, HMG-I(Y), and a GATA-1-like protein. PRR IV is the second IL-2 response element that sets in the first intron of the gene; PRR IV binds HMG-I(Y) and STAT5. Mutations on one of these two elements reduces IL-2 inducibility by to 3-fold and 2-fold respectively, but if PRR III and PRR IV are both mutated, IL-2 is canceled, indicating that both are needed for maximal IL-2R α promoter activity.(90) These two spatially separated regulatory regions can cooperate and/or are at least partially redundant to mediate IL-2R α gene inducibility. PRR IV action might be temporary while that of PRR III could be more sustained.(90)

ERK2 may play a role in IL-2, IL-2R α and IFN γ genes transcriptional activation. ERK induces AP1 transcriptional activation of its response elements in TCR-dependent genes. ERK upregulates C-FOS expression via Elk-1 phosphorylation.

In T cells MAPK pathway blockade also inhibits ERK2 phosphorylation, gene expression and protein synthesis of IL-2, IL-2R α and IFN γ . PKA and PKC inhibition reduces IL-2, IL-2R α and IFN γ expression. PKA pathway inhibition, but not PKC, results in ERK1 inhibition and ERK2 activation. MEK1 and 2 suppression significantly block IL-2 and IL-2R α expression.(86)



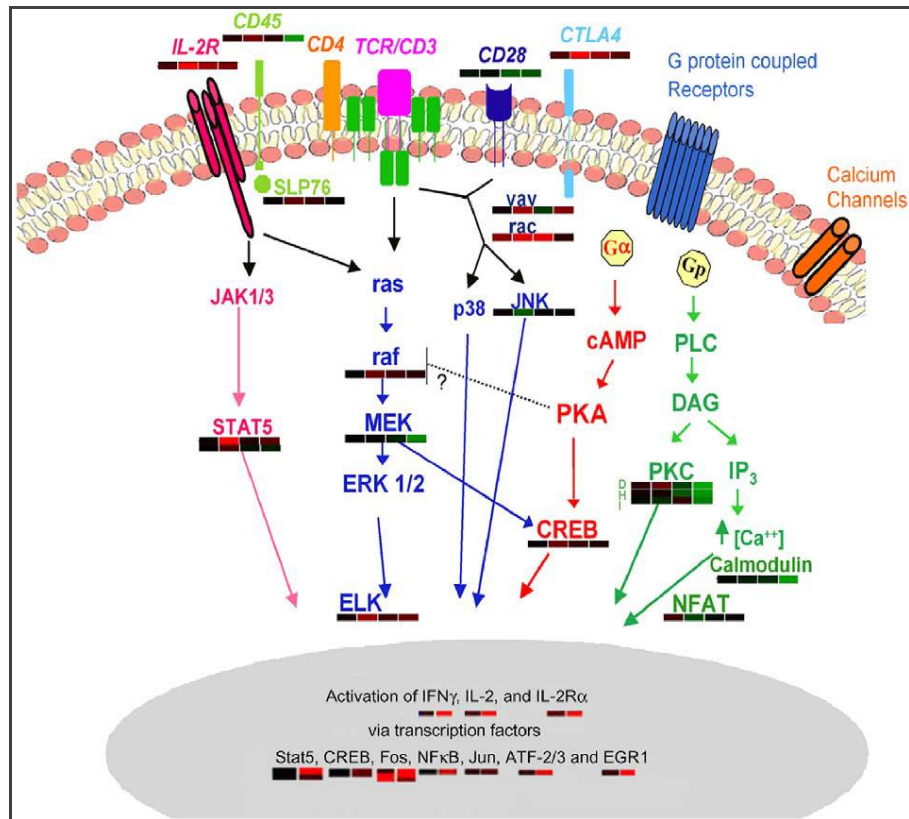

Figure 58. Signaling pathway for T cell activation.(86)

(Gene expression profiles from unstimulated and 4h after stimulation in red indicates upregulation and in green downregulation).



Part II: Personal Works



I. PHARMACODYNAMIC INVESTIGATIONS - JUSTIFICATION

To qualify as an index of CNI immunosuppressive activity a pharmacodynamic biomarker should be correlated with clinical outcomes, i.e. not far from the drug target and at the same time close to the clinical effects.

A large amount of evidence supports the concept that T cell suppression is the key mechanism by which CNI achieve immunosuppression; therefore T cells are attractive candidates for pharmacodynamic monitoring strategies.

Whole blood CNI concentrations do not reflect drug concentrations within T cells because CNI in whole blood are highly bound to erythrocytes and lipoproteins, which is subject to high inter- and intraindividual variations that also influence CNI free plasma concentrations. Another source of variability that could mainly affect immunosuppressive drugs distribution in blood are drug efflux transporters, such as P-glycoprotein, which is also expressed on T cells, the CNI cellular targets.(82)

It was hypothesized that CNI concentration in lymphocytes could be a marker of drug efficacy.(1)(91) Several works from Lemaitre et al. and Wallemacq et al. support this assumption, arguing in favor of CNI pharmacodynamic monitoring, based on the good correlations obtained between both intrahepatic and PBMC TAC concentrations and acute rejection in liver transplantation.(1)

The aim of our study was to assess protein response close to the target site and to explore downstream signal transduction from enzyme inhibition down to clinical outcomes, and at each step along the pathway to identify the major variability sources.



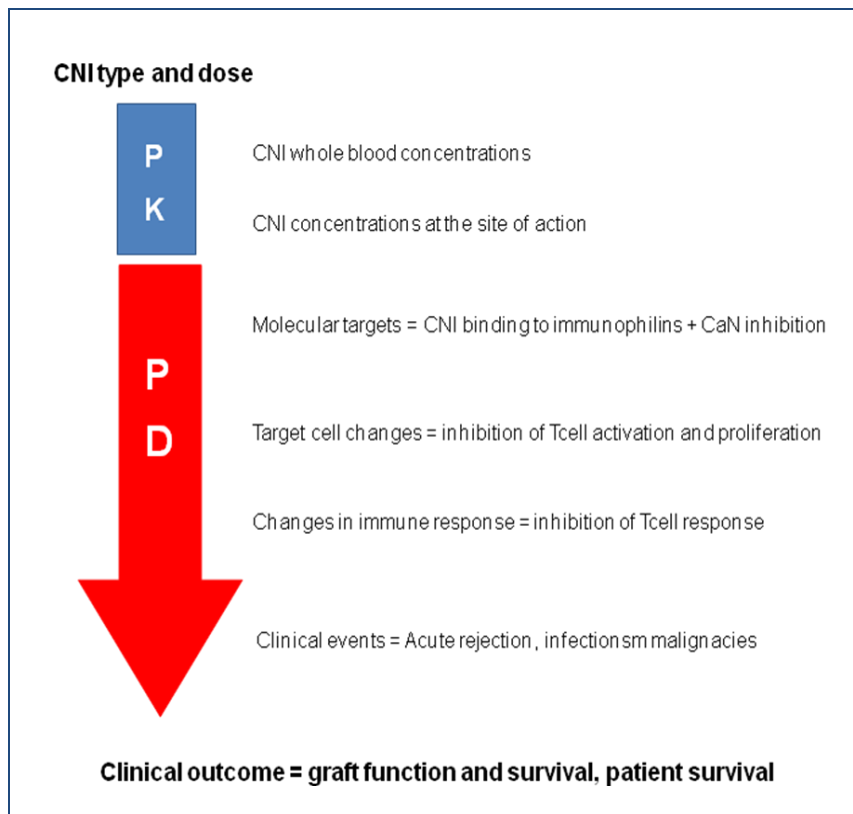

Figure 59. CNIs PK/PD effects during signal transduction.(92)

The strategy consisted to study tacrolimus exposure by a simultaneous approach through the assessment of NFAT1 (main isoform in resting and activated lymphocytes) translocation inhibition into PBMC nucleus, intracellular IL-2 expression in CD3⁺, CD4⁺ and CD8⁺ subsets and expression of the surface marker CD25 (IL-2R α) of T cell activation in T cell subsets by flow cytometry.



II. PHARMACOGENETIC INVESTIGATIONS - JUSTIFICATION

Human genotype corresponds to the blending of parental genotypes, but however two unrelated persons have over 99.9% of their DNA sequences in common. This 0.1% difference, are constituted of gene polymorphisms and are employed as markers of biologic diversity and sometimes linked to specific phenotypes of human disease. Those genome variants are spread across several genome sites such as: the promoter (5'-flanking region); the exonic regions (gene coding sequences); the intronic regions (non coding influencing sequences); and the 3' untranslated (3'-UTR) region.

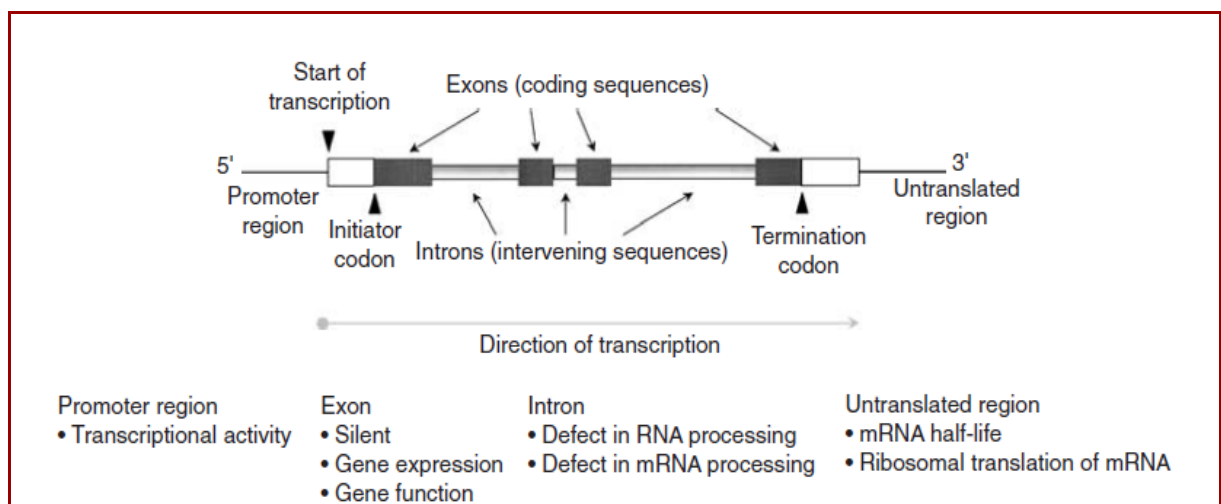

Figure 60. Structure of a human gene, sites of polymorphisms, and functional relevance.(93)

Polymorphisms located in the promoter of the gene affect transcription factor binding, transcriptional control, and other aspects of gene expression committing functionality. Exonic variants may be silent or not, influencing gene expression or function, changing the structure, binding or protein trafficking. Although introns are removed during translation (mRNA), they may influence protein functionality, leading to defects in RNA and mRNA processing. Genetic changes in the 3'-UTR region may have an impact on RNA half-life or mRNA ribosomal translation.



Three of the human gene polymorphisms described are: single nucleotide polymorphisms (SNP), variable number of tandem repeats (VNTR, also known as minisatellite polymorphism), and microsatellite polymorphisms. SNPs are the most common category, reflecting single nucleotide substitution. VNTR is the result of an insertion in tandem of multiple copies of a nucleotide sequence smaller than 100 bp long (minisatellite) and it is characterized by many alleles, based on the number of minisatellite copies. Microsatellites are DNA stretches in which a short motif of 1 to 5 nucleotides repeats several times [i.e (NN –NNN or NNNN)n] and display heritable and stable differences among individuals.

Two approaches are commonly employed to investigate genetics and human disease connections: linkage analyses and association studies. Linkage analyses reveal phenotype coinheritance within a region of the genome; in this approach environmental factors have minimal influence in disease expression, whereas association studies are better to detect susceptibility genes for “polygenic” diseases, but environment interactions are crucial in disease expression.(93)

Our research was based on the investigation of the potential variants which could lie within the promoter regions, introns and exons of calcineurin subunits and immunophilines (cyclophilin A and FKBP12), and were directly associated to downstream signaling in calcium/calcineurin/NFAT cascade.



II.1. PROMOTER SEQUENCING

The interest of this region was to investigate those polymorphisms that could modulate DNA transcription or affect mRNA stability. This part of the work, first tested in healthy volunteers was initiated by Lucie Pouché, PharmD as part of her master's research.

The candidate genes were: PPIA [peptidylprolyl isomerase A (cyclophilin A)], PPP3R1 (protein phosphatase 3, regulatory subunit B α), PPP3CA (protein phosphatase 3, catalytic subunit, α isozyme), PPP3CB (protein phosphatase 3, catalytic subunit, β isozyme), and we added ulterior FKBP1A (FK506 binding protein 1A, 12 kDa). For further details please see Supplementary material Noceti O et al. Clin Chem 2014.

Due to the characteristics of the FKBP1A region flanking the desired variation, a taqman design was not feasible, and then for patient screening this assay was performed by RFLP-PCR (Restriction fragment length polymorphism) as an alternative for sequencing.

II.2. GENOTYPING STRATEGY

A list of genes encoding proteins of the calcineurin pathway was established. After extensive literature review, we kept those that showed significant clinical association in at least two independent reports, and had a minimum MAF (Minor Allele Frequency) of 10%. Accordingly, *CALM1* [calmodulin 1(phosphorylase kinase, δ)] rs12885713; *IL2* (interleukin-2) rs2069762; *IL2RA* (interleukin 2 receptor α) rs7090530, rs10795791, rs11594656, rs35285258; *JUN*(jun proto-oncogene) rs2760501, rs4646999; and *NFATC1* (nuclear factor of activated T-cells, cytoplasmic, calcineurin-dependent 1) rs754093 were genotyped by means of Taqman® allelic discrimination assays with a Rotor-Gene Q 2plex HRM (Qiagen), according to the manufacturer's protocol. Customized assays were designed when required.



II.3. BINDING SITES VARIANTS OF NFAT1, NFAT2 AND PPP3CA

To go further, the next step intended to explore whether potential polymorphisms located at critical sites of NFAT phosphorylation and interaction between calcineurin and NFAT could influence CNI response. Literature review showed that NFAT1, NFAT2, PPP3CA, PPP3R1 and CALM were the ones with reported interacting structures. Finally, we decided to start with both NFAT isoforms and PPP3CA.

II.3.1. NFAT Mapping

The NFAT gene was mapped through the motifs that could have potential interaction with calcineurin and other proteins required for gene transcription.

For each motif, we looked at the critical interaction sites, we identified the variants and we studied their potential influence on CNI pharmacodynamics. For further details of the strategy please see Supplementary Material S1.1

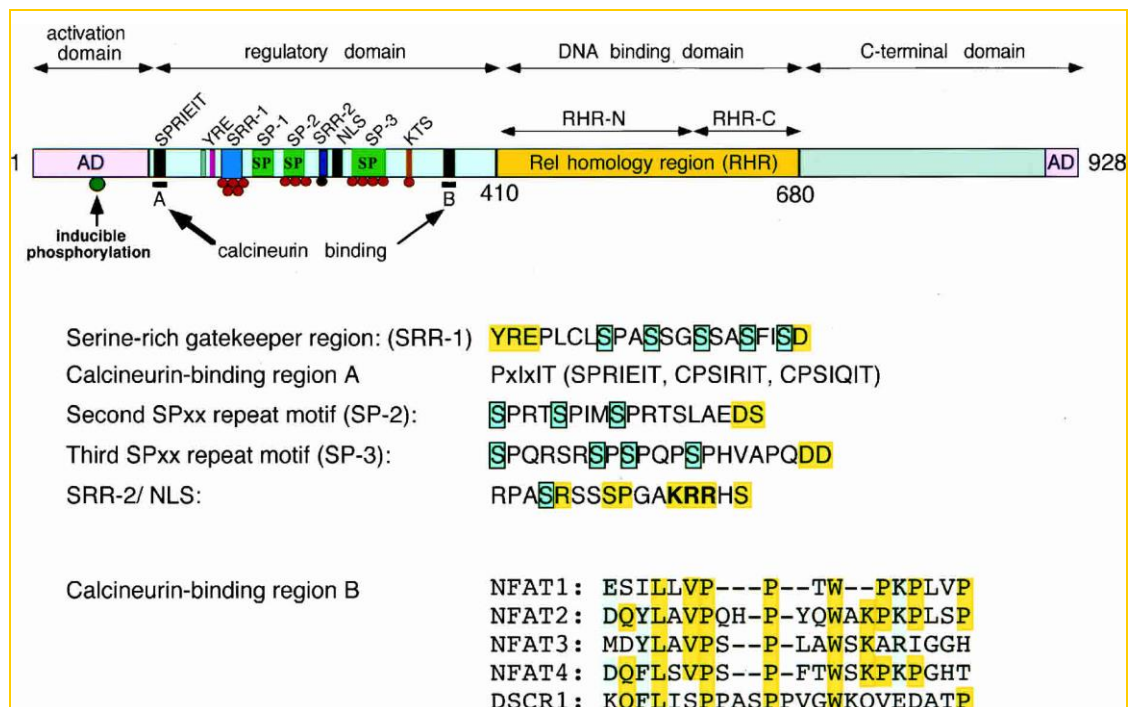

Figure 61. NFAT structure with depicted regulatory regions and calcineurin binding motifs. (59)



II.3.2.PPP3CA Mapping

A similar strategy was followed for the calcineurin catalytic subunit.

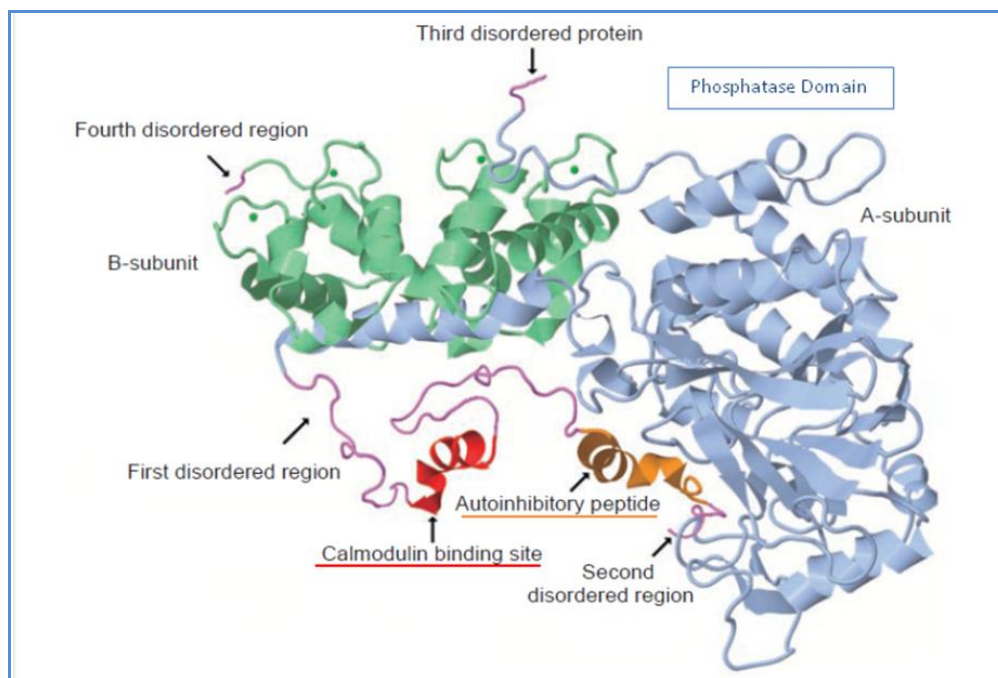

Figure 8. Ribbon representation of calcineurin subunits and critical binding sites.(45)

For further details of the strategy please see Supplementary Material S1.2.

II.4. DONOR-RECIPIENT SCREENINGS AND CNI METABOLISM

Polymorphisms may influence the activity of enzymes and transporters. CNI are metabolized by CYP3A4 and CYP3A5 in the liver and in the intestine and are expelled from the cells by efflux transporters, including the P-glycoprotein (P-gp; ATP-binding cassette sub-family B member 1, encoded by the ABCB1 gene). In liver transplantation, the recipient's intestinal genotype and the donor's liver genotype may act together in overall drug disposition, hence the importance of assessing both, better before or during the transplantation procedure in order to warn clinicians about the optimal CNI starting dose.(94)



II.4.1. ABCB1 Transmembrane Multi Drug Resistant Pump (P-gP)

CNI are substrates of P-gp which pumps back these and other xenobiotics into the intestinal lumen, decreasing their bioavailability and therefore the expected effect.

CNI cellular accumulation may partly depend on ABCB1 activity, which is controlled by environmental factors. P-glycoprotein is found in the jejunum, colon, liver, pancreas, adrenal gland and the kidney, in capillary endothelial cells in the testis and at the blood brain barrier, and in the placenta and endometrium of pregnant women.(95)

ABCB1 protects tissues from the deleterious effects of toxins. ABCB1 is a highly polymorphic gene, and different SNPs affect P-gp expression and function. Consequently, some of these SNPs might influence CNI intra-graft concentrations and therefore graft rejection rate.(1) The most frequently studied ABCB1 SNPs are 1236C>T (rs1128503, exon 12), 2677G>T (rs2032582, exon 21) and 3435C>T (rs1045642, exon 26) which associate to decreased transporter activity compared to the corresponding wild type alleles, possibly due to a loss of stability during conformational assembly of the mRNA protein.(95)(96)(97) Linkage disequilibrium between the three ABCB1 variant genotypes suggests synergism for their combined effect.(94)

Fukudo et al. reported that intestinal P-gP limits tacrolimus and cyclosporine oral absorption from the gut lumen, and as the protein is also expressed in PBMCs, it may contribute to restrain drug distribution into the cells.(98) As environmental factors for liver and PBMC after transplantation are similar, CNI accumulation in both cell types is correlated.(1)

Donnemberg et al. studied P-gp expression and function in CD4⁺ and CD8⁺ subsets both in naïve and memory T cells, to elucidate its role in CNI intracellular concentrations. Their results revealed that P-gp activity in CD8⁺ T cells is greater than in CD4⁺ cells; furthermore, in naïve T cells P-gp is more expressed than in memory T cells.(99)

Numerous studies have shown association between donor's ABCB1 polymorphisms and the risk of nephrotoxicity in kidney transplantation (100)(101)(102) which is consistent with a lower P-gp activity in variant genotype carriers and a decrease of CNI extrusion from kidneys cells, leading to nephrotoxicity. However, in liver transplantation, a study performed on 120 Caucasian LTR treated with tacrolimus showed that patients with the ABCB1 2677TT allele had less renal dysfunction 3 years



after transplantation than carriers of at least one wild type allele, but unexpectedly the heterozygous has a significantly higher risk than homozygous carriers of wild type allele.(103)

Shuker et al. as well as other authors reported that ABCB1 polymorphisms may also have some implication in the onset CNI nephrotoxicity in non-renal grafted recipients.(87) However, no association between any of the three ABCB1 genotypes and the rate of acute rejection was found in two studies.(104)(105). On the other hand a small study in 17 LTR showed that the ABCB1 2677T variant allele significantly associated with neurotoxicity.(106)

In light of these results, the value of genotyping ABCB1 variants in LTR is still debated (105)(107)(108), which is the reason why we decided to explore their potential influence in our patient groups.

II.4.2.CYP3A5

Members of the CYP3A enzyme family are the most abundant CYPs in human liver and small intestine.(109) In particular, a variant in intron 3 of CYP3A5 (A6986>G rs776746) has been systematically linked to tacrolimus dose requirements and trough blood levels. Indeed, the CYP3A5*3 (G nucleotide) allele leads to an alternative splicing defect in the mRNA resulting in a truncated enzyme (absence of enzyme activity) and defining the carriers as non-expressers.(109) Interestingly this variant is the most prominent among Caucasians and it characterizes the carriers with lower TAC requirement and clearance.(110)

On the contrary, individuals with at least one CYP3A5*1 allele (A nucleotide) are CYP3A5 expressors, and LTR expressing CYP3A5 require up to 50% higher daily doses per kg than non-expressors.(94)(97)(111)(112)(113)(114)

Several studies have agreed that donor and recipient CYP3A5 influenced C_0 /dose ratio and TAC dose requirement in LTR (115)(116)(117), but based on tissue expression, the donor (= liver) CYP3A5 genotype would impact tacrolimus pharmacokinetics the most.(108)(118)



Recipient *CYP3A5*1* genotype reduces TAC bioavailability through increased intestinal clearance, which could be more pronounced early after transplantation when the hepatic clearance is still low.(110) Jalil et al. highlighted that TAC apparent clearance was influenced by time post-transplantation and by the *CYP3A5*1* allele in pediatric LTR.(119) Furthermore, *CYP3A5* expressers in both the graft liver and the native intestine showed the lowest tacrolimus concentration/dose ratio, while recipients carrying only the intestinal *CYP3A5*1* genotype tend to require a higher dose of tacrolimus.(89)(112)(113)(111)(114)

*Shi et al. also reported a relationship between TAC nephrotoxicity and the CYP3A5*3 allele variant.(120) A study in 60 Japanese LTR showed an increased incidence of nephrotoxicity in recipients homozygous carriers of the CYP3A5*3 allele compared to carriers of one wild type alleles (117); the authors hypothesized that CYP3A5 expression in kidney could limit the local TAC exposure leading to a protective role against nephrotoxicity. On the contrary, a recent study in a cohort of 125 LTR reported no association between C₀ TAC or CYP3A5 or ABCB1 variants in donor and recipients, and chronic kidney disease after a median follow-up of 5.7±2.9 years.(121)*

*No relationship between donor CYP3A5 6986A>G genotype and graft loss or patient survival was found in 150 Caucasian LTR in the first 6 months post-transplantation (104), whereas a meta-analysis in KTR (n=1443) and LTR (n=336) showed a significantly higher acute rejection rate at one month in expressers than in non-expressers (odds ratio, 3.27; 95% CI, 1.57-6.81; P=0.002)(114). Similar observations were confirmed by Uesugi et al. who reported that patients with a liver graft carrying at least one CYP3A5*1 allele had a 2.6-fold higher acute cellular rejection rate compared to homozygous CYP3A5*3 carriers.(112)*

Moreover, a study in 64 pediatric Chinese LTR revealed that CYP3A5 expressers in both the intestine and the liver had a significantly higher risk of infection (odds ratio 3.86, p = 0.025) than non-expressers.(122)



II.4.3.CYP3A4*22

CYP3A4 is the most abundant isoform in the intestine and the liver, exhibiting a unimodal distribution, suggesting the implication of a plethora of genetic and environmental factors.(97) In addition to CYP3A5 genotype, CYP3A variants may participate in tacrolimus pharmacokinetics variability. In particular, a SNP described in CYP3A4 intron 6 (rs35599367 C>T; CYP3A4*22TT) has been associated with a reduced expression of CYP3A4 mRNA in the liver and lower tacrolimus dose requirement compared to wild type carriers (*22CC); similar to CYP3A5*3 effect.(110)(123) CYP3A4*22 and CYP3A5*3 SNPs explain more than 60 and 20% of the inter-individual variability observed in CNI trough levels, respectively.(94)

In our study, we examined the influence on CNI exposure of: recipient and donor CYP3A5 genotype, donor CYP3A4*22 as well as ABCB1 genotypes and haplotypes.



III. MATERIALS and METHODS

III.1. PHARMACODYNAMIC RESEARCH

III.1.1. Study design and subjects - 3PIGREF Clinical trial

In order to investigate CNi pharmacodynamics, a non-interventional study was set up (3PIGREF- Ref. NCT01760356 *ClinicalTrials.gov*). It comprises three groups: the first one is comprised of healthy volunteers and the other two are patients, registered on the waiting list of liver transplantation and LTR, respectively.

III.1.2. Chemicals and reagents

The lymphocyte density-gradient separation medium was purchased from Eurobio; RPMI 1640 1X medium, supplemented with 10% of heat-inactivated Fetal Bovine Serum (FBS), 10% of PenStrep 5000U/ml of penicillin, 5000 ug/ml of streptomycin and 10% of L-Glutamine 200 mM 1X from Life Technologies; phosphate buffered saline (PBS) 1X without calcium from Life Technologies; Phorbol 12-Myristate-13-Acetate (PMA), calcium ionophore and Concanavalin A from Sigma Aldrich. Tacrolimus (TAC) pure substance was kindly provided by Astellas Pharma.

The peripheral blood mononuclear cell lysis buffer (10 mM Pipes, MgCl₂ 2 mM, NaCl 0.1M and Triton 100X 0.1%) and 1% Bovine Serum Albumin (BSA) were from Sigma Aldrich. The Golgi Plug protein transport inhibitor used for IL-2 expression measurement was from Becton Dickinson, and the IntraPrep kit from Beckman Coulter.

The anti-human T cell surface marker CD3 PerCP-Cy5.5, CD4 FITC, CD4 PE, CD8 PE-Cy7, PE Rat Anti-Human IL-2, PE Rat IgG2a κ as isotype control, CD25 APC; the anti-NFAT1 antibodies (Purified Mouse Anti-NF-ATc2) and Purified Mouse Anti-NF-AT1 were all from Becton Dickinson. The PE polyclonal IgG (Goat F(ab')₂ Fragment Anti-Mouse IgG(H+L)) was from Beckman Coulter.



III.1.3.PBMC Separation

35ml of blood was drawn under fasting conditions into 6ml sodium heparin vacutainer tubes (Becton Dickinson, France) and the fresh PBMC fraction was obtained using lymphocyte density-gradient separation.

Cells were re-suspended in RPMI 1640 1X supplemented medium [10% of heat-inactivated Fetal Bovine Serum, 10% of PenStrep 5000U/ml of penicillin, 5000 ug/ml of streptomycin and 10% of L-Glutamine 200 mM 1X], and counted in a cell-counter (Cell Dyn® EMERALD™, Abbott Diagnostics Division, France and ABX® Micros 45 OT, HORIBA, Uruguay).

III.1.4.Ex-vivo TAC exposure in Healthy Volunteers

For each set of markers, aliquots of 1×10^6 PBMC in 100 μ l of RPMI were incubated ex-vivo for 30 min at 37°C in a humidified atmosphere at 5% CO₂ (in 96-well sterile plates) with 0 to 50 ng/ml of TAC in RPMI 1640 1X.

III.1.5.NFAT1 translocation to the nucleus of PBMC cells

To assess the degree of NFAT1 translocation into the nucleus, an indirect (secondary) antibody staining technique was employed. The unlabeled first (primary) antibody specifically binds the target molecule, and the secondary antibody with the fluorophore recognizes the primary antibody and binds to it; this method improves dye sensitivity to signal amplification.

The procedure started with aliquots of 1 million cells in 100 μ l of supplemented RPMI, treated with 0 - 50 ng/ml TAC during 30 min at 37°C and 5% CO₂, followed by incubation with 50 ng/ml PMA and 2.5 μ g/ml calcium ionophore for another 30 min at 37°C and 5% CO₂. After two washes with cold PBS 1X, cells were incubated 30 min on ice with PIPES lysis buffer (pH 7.4 in PBS 1X). Subsequently to two extra washes with BSA 1% in cold PBS 1X, a mix of 50 μ l of anti-NFAT1 antibodies at 5 μ g/ml in PBS 1X was added to the medium for another 30 min incubation on ice. Then a labeled PE polyclonal IgG (Goat F(ab')₂ Fragment Anti-Mouse IgG(H+L) at 0.33% was added. After 15 min incubation on ice in the dark, the resulting fluorescent signal of labeled PBMC nuclei was



measured by flow cytometry, and the mean NFAT1 fluorescence intensity in the separated nuclei used for statistical analysis.

III.1.6. Intracellular IL-2 expression in CD4+ and CD8+ T cell subsets

After TAC exposure or directly after PBMC separation, aliquots of 1 million cells in 100 μ l of supplemented RPMI were stimulated with 50 ng/ml phorbol 12-myristate 13-acetate (PMA), 2.5 μ g/ml calcium ionophore and 1 μ g/ml Golgi Plug for 5h at 37°C in a humidified atmosphere with 5% CO₂. Cells were then i) stained with anti-human T lymphocyte surface markers (CD3 PerCP-Cy5.5, CD4 FITC, CD8 PE-Cy7; ii) fixed; iii) permeabilized (IntraPrep); iv) stained with PE Rat Anti-Human IL-2 and PE Rat IgG2a κ as isotype control; and v) analyzed by flow cytometry.

III.1.7. IL-2R α expression at the surface of CD3+ T cells

For CD25 expression measurement, PBMC aliquots were incubated for at least 72h at 37°C and 5% CO₂ in the presence of 7.5 μ g/ml Concanavalin A in RPMI 1640 1X.

After two additional washes in PBS 1X, direct staining was performed using: CD3 PerCP-Cy5.5, CD4 PE, CD8 PE-Cy7 and CD25 APC. 30 min later of incubation in darkness, and several washes with BSA in PBS 1X / PBS 1X, flow cytometry analysis was performed.

IL-2 and CD25 expression were reported as the percentage of fluorescent positive cells over the CD4⁺, CD8⁺ or CD3⁺ fractions, respectively.



III.2. PHARMACOGENETIC STUDY

QIAamp DNAMini Kit 51306 from Qiagen was used for DNA extraction, while DNA Nucleospin Plasma 740900 from Macherey-Nagel, Germany was employed for DNA sera samples.

III.2.1. Promoters sequencing

For sequencing we used: the PCRx Enhancer system 11495-017 (10x PCRx Rxn Buffer, 10xPCR Enhancer Solution, 50nM Magnesium Sulphate, Platinum® Taq DNA Polymerase); 10 mM dNTP Mix 18427088 and BigDye® Terminator v3.1 Cycle Sequencing Kit 4337456 from Life Technologies, France; the QIAquick PCR Purification Kit 28106 and Dye-Ex 2.0 Spin Kit 63206 from Qiagen, Hilden, Germany. Customized primers were provided by Eurofins MWG Operon, Germany.

DNA was sequenced for the promoter region of PPIA [peptidylprolyl isomerase A (cyclophilin A)], PPP3R1 (protein phosphatase 3, regulatory subunit B, α), PPP3CA (protein phosphatase 3, catalytic subunit, α isozyme), PPP3CB (protein phosphatase 3, catalytic subunit, β isozyme), and FKBP1A (FK506 binding protein 1A, 12 kDa) to investigate polymorphisms that could modulate DNA transcription or mRNA stability. 10ng of genomic DNA were amplified using forward and reverse primers as described below.

Table III.2.1.1. Primers sequences and amplimers size for gene promoter assays investigations.

Gene	Forward primer	Reverse Primer	Amplimer size
PPIA	5' CTCTGTGCAATGGGGAGAC 3'	5' AAAATGGCCCCCTCGTCAG 3'	652bp
PPIA	5'- GCACTGTCACTCTGGCGAAG 3'	5' GCTACCACCCACCCCGAC 3'	652bp
PPP3CA	5' ACTGAGTGATGCGCCCTCTA 3'	5' ACTTGGGATCAATTGCCTTG 3'	948bp
PPP3CB	5' TATGGCGCTAAATTGCTCT 3'	5' CAGGGTTTCGTCCACCTCT 3'	687bp
PPP3R1	5' ACCCTCGCATTTCCTCCTT 3'	5' CAGTAGGGGGAGGGATGGT 3'	787bp
FKBP1A	5' CACCTGTGCGCTGTCTTCT 3'	5'GTCTGAATCGGCGGCTGT 3'	536bp



For each studied promoter region, the PCR reaction involved a first denaturation step at 94°C for 2min, followed by 35 cycles of denaturation at 95°C for 30sec, annealing at 55°C for 30sec, and extension at 68°C for 1min. The last step consisted of a final denaturation at 72°C for 7min. The reaction mix was composed of 5µL of PCRx amplification buffer, 10mM of dNTP, 75mM of MgSO4 and 2.5UI of Platinum TAQ DNA polymerase, and 10µL of PCRx Enhancer Solution at final concentration of 2X.

Amplimers were purified with the QIAquick PCR Purification Kit. Sequencing reaction mix contained 4µl of BigDye® Terminator v3.1 Cycle Sequencing Kit, 4µL of amplimers, 2µl of either the forward or the reverse primer. Confirmation using the opposite primer was performed whenever required.

Sanger sequencing reaction consisted of a first denaturation step (94°C for 3 min), followed by 25 cycles of denaturation at 94°C for 10sec, hybridization at 50°C for 5sec and elongation at 60°C for 4min.

The final denaturation step lasted 1 min at 60°C. Finally, the sequencing products were purified using Dye-Ex 2.0 kit before separation by capillary electrophoresis on ABI 3130 XL Genetic Analyzer, Life Technologies.

Sequences were then mapped to the reference sequence of the corresponding gene, and genetic variants identified, using SEQUENCHER 4.8 sequence analysis software, Gene Codes Corporation, Ann Arbor, MI USA.

FKBP1A was sequenced only for healthy volunteers; in patients we used restriction fragment length polymorphism PCR analysis.

FKBP1A primer sequences.

Gene	Forward primer	Reverse Primer	Hybridation Temperature
FKBP1A	5'-GGAGATGCTTAACCGGCTG-3'	5'-CGGCTCTGCCTAGTACCTC-3'	54°C



PCR conditions*	Time	Temperature
<i>Starting cycle</i>	<i>5 min</i>	<i>95°C</i>
<i>30 cycles</i>	<i>30 sec</i>	<i>95°C</i>
	<i>30 sec</i>	<i>T hybridation</i>
	<i>30 sec</i>	<i>72°C</i>
<i>Final cycle</i>	<i>5 min</i>	<i>72°C</i>

*Valid for PCR analysis of binding sites, RFLP and donor-recipient screenings.

The amplification product was separated using acrylamide gel 6%, (60 minutes at 100 volts) previously digested with restriction enzyme *AvaI* (2hs a 37°C); afterwards the product was exposed to silver nitrate 0.2%.

<i>Genotyping Code</i>		
<i>CC</i>	<i>AA</i>	<i>CA</i>
<i>142pb+103 pb</i>	<i>245 pb</i>	<i>245 pb+142pb+103pb</i>

Table III.2.1.2. Polymorphisms and locations of gene promoter assays.

<i>Gene</i>	<i>rs</i>	<i>Chromosome</i>	<i>Location</i>	<i>Allele Change</i>	<i>MAF</i>
PPIA	8177826	7	5'UTR	C>G	G=0.039/196
	6850	7	5'UTR	A>G	G=0.421/2108
FKBP1A	141252617	20	UTR2KB	C>A	T=0.0024/12
PPP3R1	72174030	2	UTR2KB	Ins29bp	NA
	4347819	2	UTR2KB	T>C	C=0.228/1144
	4519508	2	UTR2KB	C>T	T=0.462/2315
PPP3CA	149278688	4	5'UTR	C>A	A=0.0068/34
	45441997	4	5'UTR	(GGC)10>8	NA

MAF values are based on 1000G database source. Last entry to NCBI Data Base and ENSEMBL Genome Browser was done on January 28, 2015.



III.2.2. Genotyping assays

CALM1 [calmodulin 1 (phosphorylase kinase, δ)] rs12885713; IL2 (interleukin-2) rs2069762; IL2RA (interleukin 2 receptor, α) rs7090530, rs10795791, rs11594656, rs35285258; JUN (jun proto-oncogene) rs2760501, rs4646999; and NFATC1 (nuclear factor of activated T-cells, cytoplasmic, calcineurin-dependent 1) rs754093 were genotyped by means of Taqman® allelic discrimination assays with a Rotor-Gene Q 2plex HRM (Qiagen), according to the manufacturer's protocol.

SNP assays were ordered from Applied Biosystems™ as custom assays (JUN assay ID AHQJQOX and NFATC1 assay ID AH6R205) or inventoried as TaqMan SNP Genotyping Assays.

Table III.2.2.1. Polymorphisms and locations of the genes of calcineurin pathway.

Gene	rs	Chromosome	Location	Allele Change	MAF
CALM1	12885713	14	5'UTR	C>T	T=0.2897/1495
IL2	2069762	4	UTR2KB	A>C	C=0.2710/1356
	7090530		5'UTR	A>C	C=0.3786/1895
IL2RA	10795791	10	5'UTR	G>A	G=0.4357/2182
	11594656		5'UTR	T>A	A=0.1466/733
	35285258		UTR	C>T	T=0.1464/733
JUN	2760501	1	UTR2KB intronic	T>G	G=0.3580/1793
	4646999		UTR-673C	A>G	A=0.4539/2273
NFAT2	754093	18	Missense intronic	T>G	G=0.3389/1697



III.2.3. Binding Site Variants of NFAT1, NFAT2 and PPP3CA

PCR products were sent to Macrogen Korea for sequencing. Primers were provided by Macrogen (www.dna.macrogen.com).

Fragments were purified in agarose gel 2% using Zymoclean™ Gel DNA Recovery Kit (D4001).

Table III.2.3.1. Primers sequences and hybridation temperatures for NFAT1, NFAT2 and PPP3CA gene sequencing.

Gene	Forward primer	Reverse Primer	Hybridation Temperature
NFAT1	5' GAGACGAAATCCAGCCTGTG 3'	5' AAATGAAGCTGGCAGAGGAG 3'	54°C
	5' CGCCAGCCCAGGTTTAC 3'	5' GAGGCTGTTTCAAGGCATC 3'	
	5' CGCAGCCCTCATCTCACG 3'	5' TAAACCTGACTCTGAATCCC 3'	
NFAT2	5' GTTCATGGGTTTCTGCTTTG 3'	5' ACGTCTTCCACCTCCACATC 3'	57°C
	5' ATAACCTCGTGCTTGGGCC 3'	5' GCCAGCTCTCCTCAGTGACG 3'	61°C
	5' TGTCTCCAAGACCACGGAC 3'	5' GACGGGCTCCACCTTGAG 3'	59°C
	5' ATGGCGTCCCTGTCAAGTC 3'	5' TGA CTCTCGTCCCAGACAC 3'	50°C
PPP3CA	5' AAATAACCACCACACACGC 3'	5' GCTCCGCTTACCTTTCACC-3'	57°C



III.2.4. Donor – Recipient Pharmacogenetics of CNI metabolism and transport protein: ABCB1, CYP3A5 and CYP3A4*22

ABCB1 MDR1, CYP3A5 and CYP3A4*22 variants were studied by allele specific PCR analysis (Taqman® or laboratory developed and Taqman). Among these, the ABCB1 exon 12 rs1128503 assay by PCR allele specific method did not work, and was repeated by Taqman®.

Each DNA was analyzed using two reactions using Fwt-Rev and Fmut-Rev. Amplicons underwent an acrylamide gel electrophoresis 6% (50 min. 100 Volts). The gel was exposed to silver nitrate 0.2%, and the alleles were identified through the observation of an amplified fragment.

Table III.2.4.1. Primer sequences and hybridation temperatures for ABCB1 and CYP3A4 assays.

Gene	Forward primer	Reverse Primer	Hybridation Temperature
ABCB1 rs10410642 Fseq Fwt Fmut	5'AGCCCATCCTGTTTGACTGC 3' 5' GTGGTGTCACAGGAAGAGAGT 3' 5' GTGGTGTCACAGGAAGAGAGC 3'	5'CAGGTAAGGGTGTGATTGG 3'	55°C
ABCB1 rs1128503 Fseq Fwt Fmut	5'AGTTCCTATATCCTGTGTCTGTG 3' 5'GTCCTGGTAGATCTTGAAGGTT 3' 5' GTCCTGGTAGATCTTGAAGGTC 3'	5'AGAAAGATGTGCAATGTGACTG 3'	55°C
ABCB1 rs2032582 Fseq Fwt Fmut	5' TGTCTGATAGTGGGTCTCTGTC 3' 5' GTGTCTCCATCACACCCACC 3' 5' GTGTCTCCATCACACCCACT 3'	5' CACCTTTTTACCATCCTTCC 3'	55°C
CYP3A4*22 rs35599367 Fseq Fwt Fmut	5' TGTCTGATAGTGGGTCTCTGTC 3' 5'- GTGTCTCCATCACACCCACC-3' 5'- GTGTCTCCATCACACCCACT-3'	5' CACCTTTTTACCATCCTTCC 3'	55°C

Fseq and reverse primers were used to check the system by sequencing.

For CYP3A5 polymorphisms, two separate reactions were accomplished to test each DNA: 3A5For-3A5*3Rev and 3A5F-3A5*1Rev.



Table III.2.4.2. Primer sequences and hybridation temperatures for CY3A5 assay.

Gene	Forward primer	Reverse Primer	Hybridation Temperature
CYP3A5 rs776746			
Forward	5' CATGACTTAGTAGACAGATGAC 3'	5' GTCCAAACAGGGAAGAGATTC3'	58°C
3A5*3 Rev		5' GTCCAAACAGGGAAGAGATCT 3'	
3A5*1 Rev			

Table III.2.4.3. Gene variants, location, function and MAF for ABCB1, CY3A5 and CYP3A4 assays.

Gene	rs	Chromosome	Function	Allele Change	MAF
ABCB1	rs1128503	7	CDS-Synonymous codon, Exon 12	C1236T	T=0.416/208
	rs2032582	7	Missense, Exon 21	G2677T	T=0.334/1673
	rs1045642	7	CDS-Synonymous codon, Exon 26	C3435T	T=0.395/1979
CYP3A5	rs776746	7	Intronic	A>G	G=0.379/1895
CYP3A4*22	rs35599367	7	Intronic	C>T	T=0.015/75



III.3. STATISTICAL METHODS

III.3.1 Healthy Volunteers and Patients of the Waiting List for Liver Transplantation

For the healthy volunteers and patients of the waiting list for liver transplantation study, distribution normality was tested using the Shapiro–Wilk test and, when needed, data were log-transformed.

Flow cytometry results were analyzed vs. the logarithm of TAC concentration using sigmoidal inhibition models (GraphPad PRISM®, version 5.02), to derive basal activity (I_0), 50% inhibitory concentration (IC_{50}), and maximal inhibition (I_{max}). IL-2 in $CD4^+$ and $CD8^+$ cells and CD25 in $CD3^+$ cells were studied as a function of NFAT1 expression by use of a large variety of models classically used for enzyme inhibition or receptor response, as well as simpler linear and nonlinear regression models.

In all cases, we evaluated goodness of fit using nonparametric tests.

The influence of gene polymorphisms was tested with R version 2.15.1 (R foundation for statistical computing, <http://www.r-project.org>).

Conformity of genotyping data with Hardy–Weinberg equilibrium was verified using the Fisher exact test with the “SNPassoc” package. Linkage disequilibrium was investigated for rs72174030, rs4347819, and rs4519508 (PPP3R1, chromosome 2) and for rs10795791, rs11594656, and rs35285258 (IL2RA, chromosome 10), and the most probable haplotypes were inferred using the “haplo.stat” package.

The relations between single nucleotide polymorphisms (SNPs) or haplotypes and pharmacodynamic parameters (I_0 , IC_{50} , and I_{max}) of the respective phenotypes were investigated by use of multiple linear regression.

We compared recessive, dominant, and log-additive models on the basis of the Akaike information criterion. SNPs or haplotypes characterized by $P < 0.05$ were included in an intermediate multivariate model and retained in the final multivariate model only if they survived backward selection on the basis of the Akaike information criterion.



The Bonferroni correction was applied to the final models to account for multiple testing. We estimated the percentage of variability explained by the SNPs or haplotypes in these final models through their R^2 coefficients.

The percentage of contribution to the overall variability was calculated for each variable using ANOVA, as the ratio of variability associated to the variable divided by total variability (= sum of the variability of each variable and of residual variability).

III.3.2. Transversal Group of Liver Transplant Patients

Distribution normality was tested using the Shapiro-Wilk test and when needed, data were log-transformed.

Conformity of genotyping data with the Hardy–Weinberg equilibrium was verified using the Fisher’s exact test with the “SNPassoc” package of R v2.15.1 (R foundation for statistical computing, <http://www.r-project.org>). Linkage disequilibrium was investigated for rs72174030, rs4347819 and rs4519508 (PPP3R1, Chromosome 2) and for rs10795791, rs11594656, rs35285258 (IL2RA, Chromosome 10) and the most probable haplotypes were inferred with the “haplo.stat” package.

We conceived a model based on the steps of calcineurin pathway, and we fed it with the covariables that we understood were the most pertinent at each step. The relations between SNPs or haplotypes and pharmacodynamic biomarkers of the respective phenotypes were investigated using multiple linear regression. A univariate analysis was first performed and PD parameters, SNPs or haplotypes characterized by $p < 0.05$ were included in an intermediate model. The final model was selected using a backward stepwise process based on the likelihood ratio test for covariate selections. The Bonferroni correction was applied to the final models to account for multiple testing (11 tests). The percentage of variability explained by the SNPs or haplotypes in these final models was estimated using ANOVA.



IV.RESULTS

3PIGREF clinical trial was analyzed by the intention-to-treat (ITT) approach. A total number of 35 healthy volunteers and 87 patients were enrolled, including 19 from the waiting list. From the transplant cohort one patient had to be retransplanted, 13 were switched to everolimus during the follow up and two recipients did not take CNI.

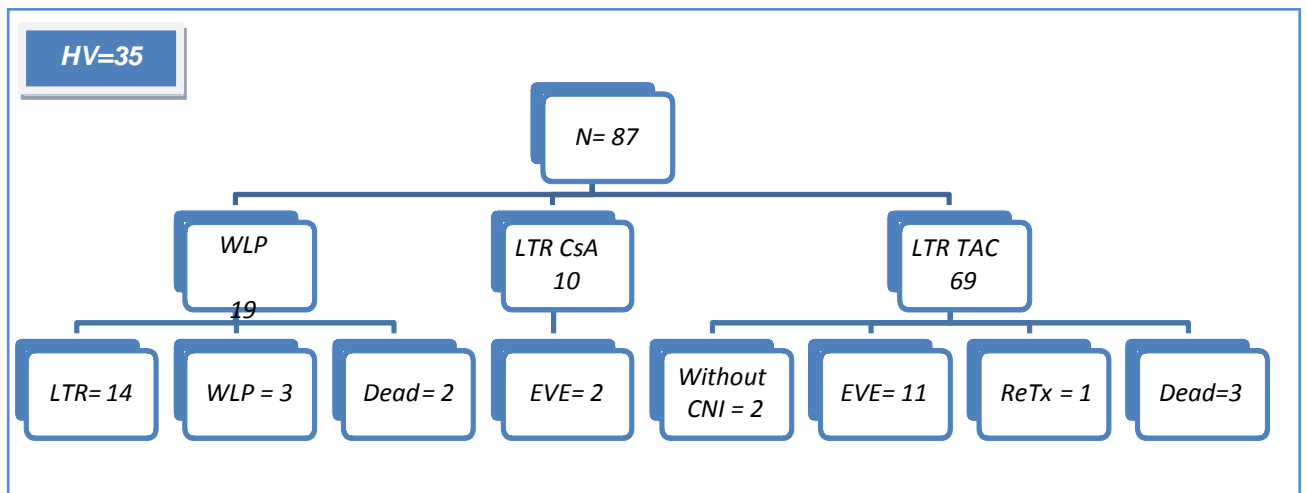

Figure 62. 3PIGREF ITT approach.

For each pharmacodynamic biomarker the limit of detection of the technique was assessed using the FMO (fluorescence minus one) principle, which means that all antibodies were present in the tube except the one of interest in each case. 50.000 events were recorded during acquisition. The results are shown in Table 1.

Table IV.1. Limit of detection of analytical protocols for PD biomarkers under stimulated conditions. All values correspond to fluorescence readouts.

PD biomarker	LOD
NFAT1 in PBMC ⁺ stim	30 MFI (0.2%)
IL-2 in CD4 ⁺ stim	0.2%
IL-2 in CD8 ⁺ stim	0.2%
CD25 in CD3 ⁺ stim	0.1%
CD25 in CD4 ⁺ stim	0%
CD25 in CD8 ⁺ stim	0%

IV.1. HEALTHY VOLUNTEERS (ARTICLE N°2)

The results of this study have been published in *Clinical Chemistry* 60:10 1336–1345 (2014), with title: **“Tacrolimus Pharmacodynamics and Pharmacogenetics along the Calcineurin Pathway in Human Lymphocytes”**(2)

This is the first time this signaling cascade has been fully explored dynamically in humans and strong pharmacogenetic influence was evidenced on both the physiological activity of this pathway and TAC pharmacodynamics. Table IV.2 summarize the mean and intraindividual variability of tacrolimus pharmacodynamics parameters in healthy volunteers.

Table IV.2. Intraindividual variability of TAC PD parameters in healthy volunteers; Mean and (CV%).(2)

PK	NFAT1 (MFI) (CV%)	IL2 ⁺ CD4 ⁺ (%) (CV%)	IL2 ⁺ CD8 ⁺ (%) (CV%)	CD25 ⁺ CD3 ⁺ (%) (CV%)
I_0	719 (17)	39 (11)	16 (20)	47(11)
IC_{50}	0.5 (226)	0,6 (449)	1,0 (7446)	1,7 (270)
I_{max}	251 (14)	0,3 (71)	0,8 (195)	38 (14)

MFI, mean fluorescence intensity.

We found that the inhibition of NFAT1, IL-2, and CD25 expression after TAC exposure followed I/I_{max} models. After log transformation of all parameters (as most were not normally distributed), mild to moderate interindividual variability was found for the physiological level (I_0) (CV 11% to 20%) as well as for NFAT1 and CD25 I_{max} values (CV 14%), whereas much larger interindividual variability was yielded for IL-2 I_{max} in CD4⁺ and CD8⁺ cells (CV 71% and 195%, respectively). These two readouts very close to detection limit of the technique (0.2%).



IL-2 and CD25 response vs. NFAT1 nuclear translocation inhibition in PBMC nuclei fitted an allosteric sigmoidal model, consistent with tight signal translation along the calcineurin pathway. TAC IC₅₀ increased gradually from NFAT1 to CD25 expression in lymphocytes (NFAT1 < IL2⁺CD4⁺ < IL2⁺CD8⁺ < CD25⁺CD3⁺) reinforcing signal consistency along the pathway. Intra-assay variability was checked, showing CV values < 9%, while intraindividual variability estimated in 3 different healthy volunteers was below 7% for I₀ and 17% for IC₅₀, except for NFAT1 (IC₅₀ CV% = 50%).

At I_{max}, 17%–83% of PBMC nuclei still expressed NFAT1, 0%–18% CD4⁺ and 0%–62% CD8⁺ T lymphocytes expressed IL-2, and 29%–71% of CD3⁺T cells expressed CD25⁺ on their membrane. The IC₅₀ of each biomarker increased along the CaN pathway, from a geometric mean of 1.3 ng/mL for NFAT1 to 4.8 ng/mL for CD25 (Table 3). Individual IC50 values varied in a 1000-fold range for NFAT1 and CD25, 2000-fold for IL-2 in CD4₋ cells, and 10 000-fold for IL-2 in CD8₋ lymphocytes.

The pharmacogenetic association study in these healthy volunteers suggested that the haplotype of three SNPs present in the IL-2 α chain receptor downregulates (in stimulated conditions) the expression of IL-2 in CD4⁺ subset while the mutated configuration of two of the alleles of rs11594656 and 35285258 downregulates CD25 expression in T lymphocytes (Table IV.3).

A variant within the promoter region of cyclophilin diminishes tacrolimus IC₅₀ for inhibition of NFAT1 nuclear translocation, whereas I_{max} seems to be affected by IL-2 expression in CD4⁺ T cells, and upregulated when the triplet (GCC)_{10/10} is present as a polymorphism of the calcineurin catalytic subunit promoter.



Table IV.3. Significant results after Bonferroni correction of PD/PK/PG relationships in healthy volunteers.

PD parameter	PD biomarker	Associated SNP	Genetic Model	$\beta \pm SD$	Modulation	Corrected p value* (Multivariate Model)
I_0	$IL-2^+CD4^+$	haplotype IL2RA wt	ATC vs AAT	-0.37 ± 0.10	↓	0.012
	$CD25^+CD3^+$	haplotype IL2RA	AAT vs ATC	-0.48 ± 0.06	↓	0.012
IC_{50}	NFAT1 ⁺ PBMC nuclei ⁺	rs8177826 PPIA	G vs C	-1.44 ± 0.43	↓	0.042
I_{max}	$IL-2^+CD4^+$	rs45441997 PPP3CA	(GCC) _{10/10} vs _{8/8}	0.25 ± 0.07	↑	0.028

Haplotype IL2RA: rs10795791, rs11594656, and rs35285258



IV.2. BINDING SITE VARIANTS of NFAT1, NFAT2 and PPP3CA

The variants in the different regions of NFAT exon 2 reported in the literature are the following: Serine Rich Region 1 (rs146706357, 140225213); Serine Repeat Motif 3 (rs 1063670, 142009203, 150655822, 139882199, 76525142); Serine Rich Region 2/ Nuclear Localization Sequence (rs 139169385, 2230112, 112028090) and Activator Protein 1 (rs 139217071, 143975184). For PPP3CA, variants in the regions of interaction with CyPA and FKBP12 correspond to exons 9 and 10 (rs78927351), variants in the calmodulin binding motif to exon 11 (with no variant described) and variants in the auto inhibitory domain to exon 14 (rs150423845, 140517920).

Table IV.4 summarizes genetic variants resulting from exon 2 sequencing in both NFAT1 and NFAT2. PPP3CA sequencing of exon 9, 10 and 14 did not show any of the targeted variants, but some polymorphisms were detected at intron levels, which were not taken into consideration because they were out of the scope of this research.

Table IV.4. Polymorphisms of NFAT1 and NFAT2 found in exon 2.

Gene	rs	Chromosome	Function	Allele Change	MAF
NFAT1	3746420	20	CDS-Synonymous codon intronic	G>C	C=0.060/299
	2230112	18	CDS-Synonymous codon intronic	G>T	T=0.4093/2050
NFAT2	150374931	18	CDS-Synonymous codon intronic – 5'UTR	C>T	T=0.0030/15
	55863211	18	CDS-Synonymous codon intronic – 5'UTR	C>T	T=0.012/59
	1051978	18	Missense	C>A	A=0.047/233
	76525142	18	Missense	G>A	A=0.0026/13
	374831399	18	CDS-Synonymous codon intronic – 5'UTR	C>T	T=0.0006/3
	138101748	18	CDS-Synonymous codon intronic – 5'UTR	G>A	A=0.0050/24



IV.3. REPLICATION OF PK/PD/PG STUDY IN PATIENTS OF THE WAITING LIST (ARTICLE N°3 - DRAFT)

INTRODUCTION

The aim of the study was to verify whether the findings made in healthy volunteers could be confirmed with patients on the waiting list of liver transplantation, or if their disease status is capable to modify the ex-vivo pharmacodynamics of TAC.

MATERIALS AND METHODS

PHARMACOGENETIC INVESTIGATIONS

Please for further details see Chapter III “Materials and Methods”, Section III.2.1.Promoters sequencing and III.2.3.Genotyping assays. Only the polymorphisms of the genes involved in the calcineurin pathway which resulted significantly relevant from the healthy volunteers study were examined. (*PPIA* rs8177826 and 6850; *PPP3CA* rs45441997; *IL2RA* rs10795791, 11594656, and 35285258, coding for CD25.)

STATISTICAL METHODS

The same approach employed for healthy volunteers (2) was adopted for this research; however the polymorphisms tested were limited to those that were relevant in this previous study: *PPIA* rs8177826 and 6850; *FKBP1A* rs 141252617; *PPP3CA* rs149278688 and 45441997; *PPP3R1* rs 72174030; *IL2RA* rs 10795791, 11594656 and 35285258. Bonferroni correction was applied according to the 11 multivariate models assembled.

RESULTS

19 patients from the liver transplantation waiting list (WLP) (13 men and 6 women) were enrolled; all of them were free of immunosuppressive drugs (corticoids included)



and interferon gamma treatment for at least 6 months. Demographic characteristics of the patients and their indication for liver transplantation are summarized in Tables IV.5 and IV.6

Table IV.5. Demographic characteristics of the patients of the liver transplantation waiting list.

Age	57 (24-66)*
ABO, n	0+(6); 0-(2); A+(6); A-(1);B+(3)
CMV Status, n	-/-(3); -/+(1); +/+(9)
EBV, n	+(10); -(3); ND (6)
Renal Failure	0
T2 Diabetes	0
Ulcerative Colitis	1
Asthma/Allergy	1

*mean (range)

Table IV.6. Indication for Liver Transplantation

Etiology	# Patients
Budd Chiari Syndrome	1
Wilson's Disease	1
Primary Schlerosing Cholangitis	1
Cirrhosis	16
Alcoholic	1
Cryptogenic	4
Biliary (primary)	2
Biliary (secondary)	1
HVB+C	1
HVC	3
HCC	1
Alcoholic + HCC	1
Alcoholic + Hemochromatosis	1



PHARMACODYNAMIC PARAMETERS AND VARIABILITY

ANOVA was used to avoid the effect of inter-individual variability. Results of tacrolimus individual pharmacodynamic biomarkers and pharmacokinetic parameters are shown in Table IV.7. (Tacrolimus individual PD parameters in patients of the LT waiting list are shown in Supplemental Table S4.1)

Table IV.7. Tacrolimus PD parameters in patients of the LT waiting list (n = 19). Results are expressed as mean and inter-individual CV of log-transformed data.

PK	NFAT1 (MFI) (CV%)	IL2 ⁺ CD4 ⁺ (%) (CV %)	IL2 ⁺ CD8 ⁺ (%) (CV%)	CD25 ⁺ CD3 ⁺ (%) (CV%)	CD25 ⁺ CD4 ⁺ (%) (CV%)	CD25 ⁺ CD8 ⁺ (%) (CV%)
NS	126 (12)	0,1 (43)	16 (346)	2.3 (82)	3.1 (146)	0,4 (107)
I_0	195 (17)	25 (28)	22 (47)	11 (42)	11 (46)	5,6 (109)
IC ₅₀	0,7 (119)	2,7 (611)	3.0 (261)	3.1 (990)	4.4 (219)	5.5 (288)
I_{max}	66 (8.9)	0,9 (206)	24 (58)	43 (20)	37 (33)	31 (36)

NFAT1 in PBMC nuclei, as well intracellular IL-2 and membrane CD25 expression in each of the T cell subpopulations studied, adequately fitted I/I_{max} sigmoid models. The best and the worst fits obtained among the 19 patients are presented in figure IV.1, displaying those precise PD parameters could be obtained from these inhibition curves.



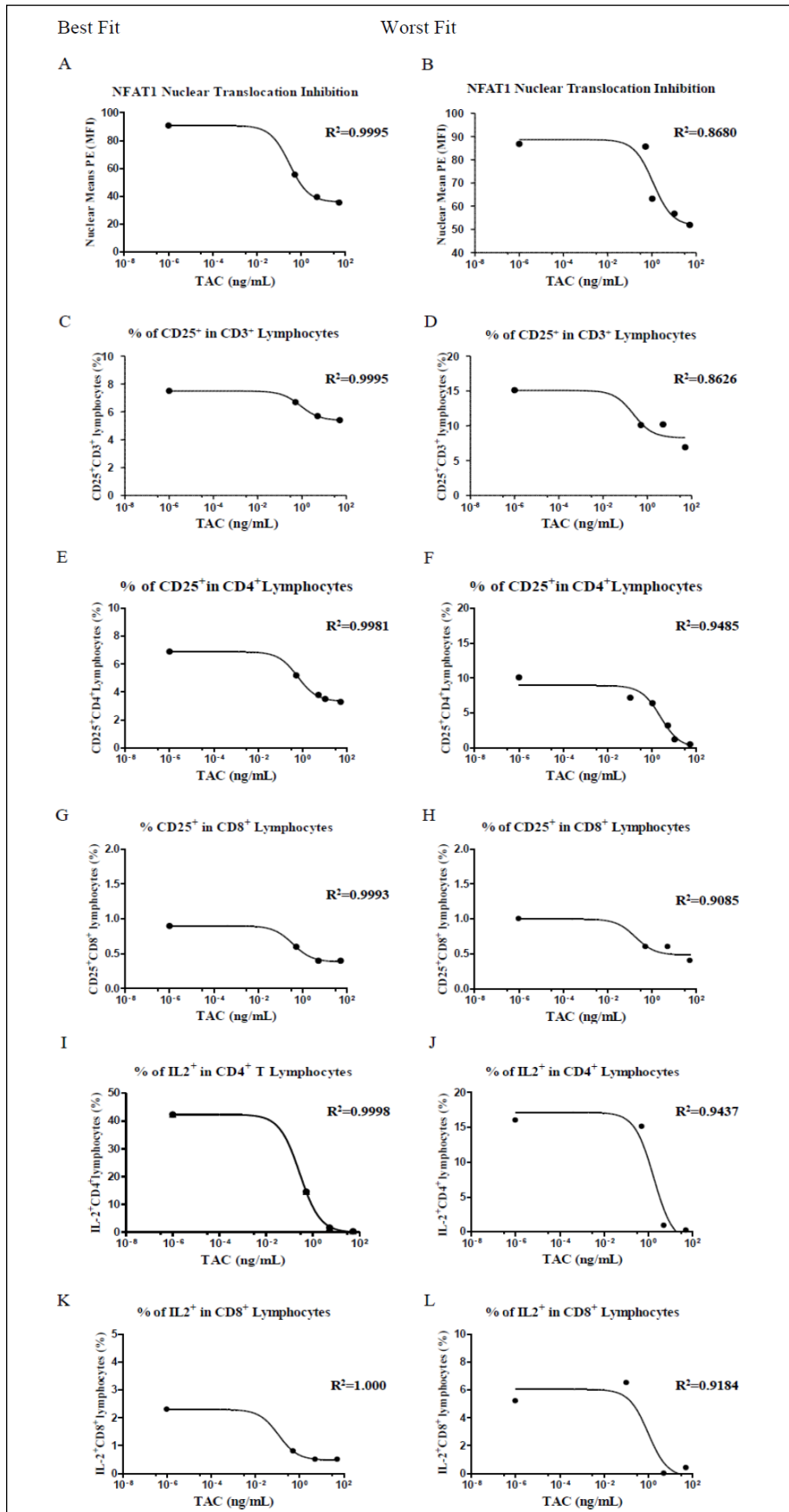

Figure IV.1. Modeling of the fluorescence intensity of biomarkers vs. TAC concentration with the sigmoid I/I_{max} model. The best (A, C, E, I, K) and worst (B, D, F, G, H, L) fits obtained are shown for NFAT1, CD25 and IL-2.



After log transformation of all parameters, mild to moderate inter-individual variability (CV = 17% to 28%) of I_0 (without TAC exposure but under stimulated conditions) levels was found for NFAT1 and IL-2 in CD4 T cells, while much larger inter-individual variability was found for all biomarkers at tacrolimus 50% inhibitory concentrations (IC_{50}), as well at unstimulated, physiological levels (except for NFAT1, CV = 12%).

Interestingly, the inter-individual variability of I_{max} was low in the case of NFAT1 (CV = 8.9%), moderate for CD25 (CV = 20, 33 and 33% for CD3⁺, CD4⁺ and CD8⁺ respectively), and the largest for IL-2 (CV = 206% and 58% for CD4⁺ and CD8⁺ respectively).

At TAC maximal inhibition, NFAT1 in PBMC nuclei, IL-2 in CD8⁺ T cells and CD25 in T cell subsets showed incomplete inhibition (Table IV.7).

The IC_{50} of each one of the biomarkers augmented along the CaN pathway, from a geometric mean of 0.7 ng/ml for NFAT1 up to 5.5 ng/ml for CD25^{High}CD8dim (Table IV.7). Individual IC_{50} values varied 100-fold for NFAT1, 200-fold for CD25 in CD4⁺, 300-fold for IL-2 in CD8⁺ and CD25 in CD8⁺ cells, 600-fold for IL-2 in CD4⁺ cells, and 1000-fold for CD25 in T lymphocytes.

Similarly to what was previously shown in healthy volunteers study (2) and by Lai et al. (125), an allosteric sigmoidal relationship between IL-2 and CD25^{High} with NFAT1 in PBMC nuclei was found here in patients of the LT waiting list (Figure IV.2).



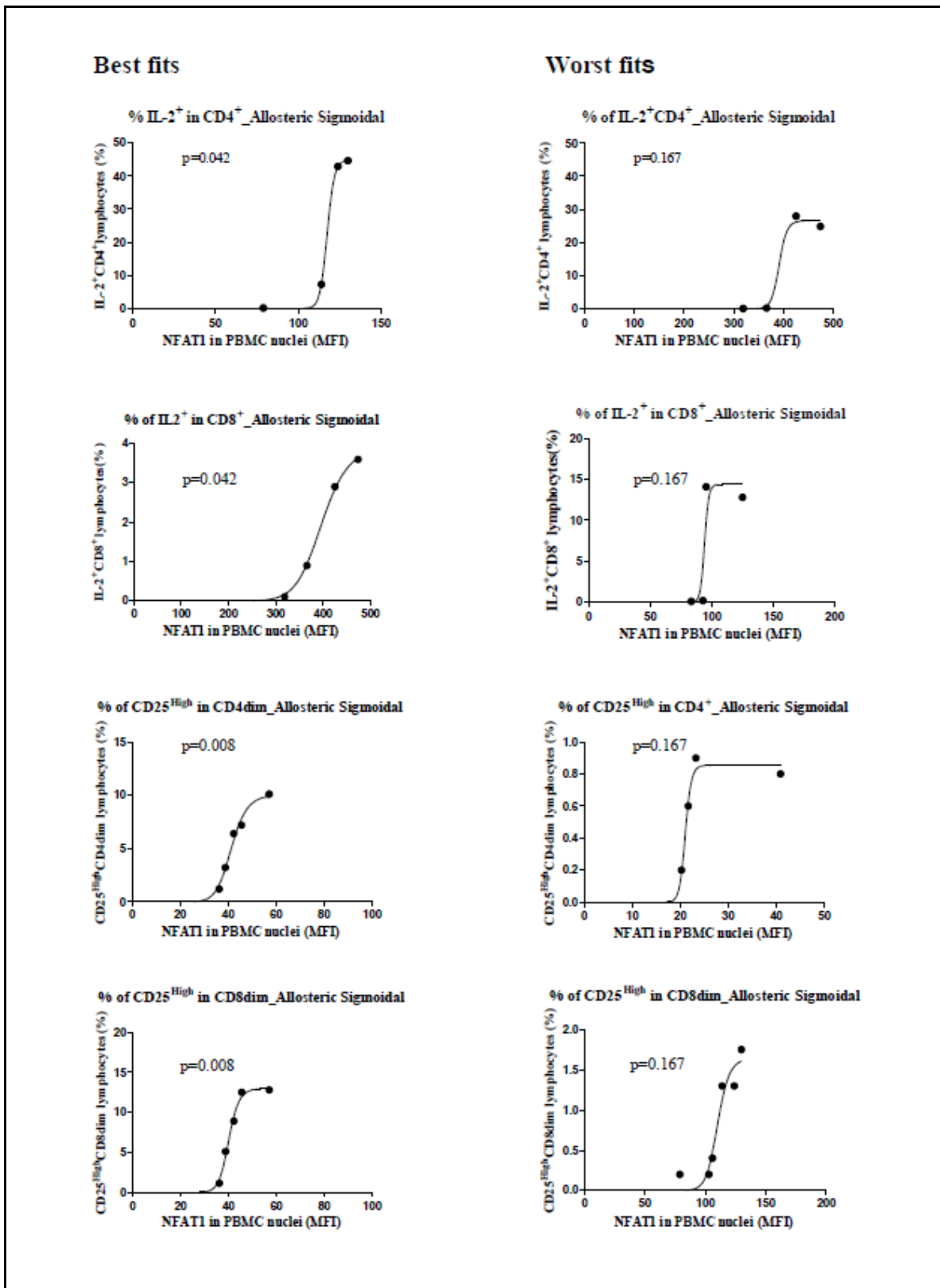

Figure IV.2. IL-2 and CD25 expression as a function of NFAT1 expression, following allosteric sigmoid models, showing the best and worst fits obtained in WLP.



PHARMACOGENETIC-PHARMACODYNAMIC RELATIONSHIPS

Associations between SNPs and phenotypes (NFAT1 in PBMC nuclei, IL2⁺CD4⁺, IL2⁺CD8⁺, CD25⁺CD3⁺, CD25⁺CD4⁺, CD25⁺CD8⁺) are presented in Table IV.8.

PPP3CA C149278688A accounted for 77% of the variability in the NS (physiological) levels of NFAT1 in PBMC nuclei (corrected p=0.0019); PPIA G8177826C 83% of CD25^{High}CD4dim I₀ variability (corrected p=0.0006); and IL2RA T11594656A 96% of CD25^{High}CD4dim I_{max} variability (corrected p=0.0001).

DISCUSSION

This ex-vivo PD study in PBMCs from patients of the liver transplant waiting list confirmed that NFAT1, IL-2 and CD25 all responded to TAC calcineurin inhibition following I/I_{max} models, as we previously showed in healthy volunteers (2), with mild to moderate inter-individual variability for NFAT1 in PBMC nuclei and IL-2⁺CD4⁺ I₀ levels, while larger variability characterizes the rest of the markers. Interestingly, physiological levels (i.e. without ex-vivo stimulation) show extensive variability, larger than in stimulated conditions, except for NFAT1 CV which remained low. The largest variability was found for TAC IC₅₀ on the different PD biomarkers, which is a measure of TAC pharmacodynamics potency, supporting the large inter-individual differences in clinical drug effects observed in routine daily practice. Surprisingly, I_{max} of the different PD biomarkers exhibited low to moderate variability, except that it was much larger for IL-2⁺CD4⁺ owing to measures below the detection limit of the flow cytometer technique (LOD = 0.15% for IL-2 in CD4 T cells)



This is the first time that the CaN/NFAT signaling cascade has been fully investigated in patients and strong pharmacogenetic influence on both the physiological activity of this pathway and TAC pharmacodynamics evidenced. Per se, the measurement of physiological PD values is innovative, and it showed that all biomarkers were measurable under non-stimulated conditions, with the exception of IL-2 in CD4⁺ T cells. “Pharmacological physiological” measurements are an advantage because the readings are free from artificial influences brought by mitogenic stimulation, which can downregulate or upregulate cell expression.

As in the healthy volunteer study, coherence of signal transduction from NFAT1 to CD25 expression in CD8⁺ T cells could be confirmed in patients of the liver transplant waiting list, suggesting higher TAC dose requirements to inhibit CD8⁺ T cell subsets than NFAT1 translocation. Moreover, IL-2 expression in CD4⁺ T cells was completely suppressed contrary to the rest of the PD biomarkers, suggesting complex and diverse signal transduction along the calcineurin pathway in the different T cell subsets.

42% of the patients had physiological (under non-stimulated conditions) and stimulated levels of IL-2 in CD8⁺ of 34 (20 - 76)% and 42 (19 - 82)% respectively and above the stimulated mean value found in healthy volunteers: 16 (5 - 37)% (Figure IV.3)



Tacrolimus IC_{50} mean values are similar to those in healthy volunteers, except for NFAT1 nuclear translocation in PBMC which is lower in the WLP; of note, NS and I_0 values are also lower than those of healthy volunteers. I_{max} values are comparable across the two groups, with the exceptions of NFAT1 and IL-2 expression in cytotoxic T cells, which seem to be more resistant to tacrolimus inhibition.

Canivet et al. reported that liver cirrhosis decrease T cell function and activation, except in HCV-positive patients whose T cells would be stimulated.(26) Our results show that CD25 expression in patients of the waiting list for liver transplantation is less than in healthy donors. The fact that our pre-transplant patients exhibited a general decrease in practically all of the biomarkers studied compared to healthy volunteers is in line with those observations. This could also help to explain the lower immunosuppressant dose requirements in liver compared to other organ transplantation.

With regard to the pharmacogenetic influence on pharmacodynamic biomarkers the results are presented in the Table IV.8.



Table IV.8. PD/PK/PG results in the waiting list for liver transplantation.

PD parameter	PD marker	Associated SNP	Genetic Model	$\beta \pm SD$ (Multivariate Model)	Modulation	p value* (Multivariate Model)	Variability Contribution (%)
NS	NFAT1 ⁺ PBMC nuclei ⁺	rs149278688 PPP3CA	C vs A	1.0 ± 0.2	↑	0.0019	77
	IL-2 ⁺ CD4 ⁺	rs45441997 PPP3CA	(GGC) _{8/8} vs _{10/10}	- 0.3 ± 0.1	↓	0.0410	36
	CD25 ^{High} CD3 ⁺	rs6850 PPIA	G vs A	2.8 ± 0.6	↑	0.0038	78
	CD25 ^{High} CD4 ⁺ (log transformed)	rs6850 PPIA	G vs A	1.9 ± 0.5	↑	0.0105	69
	CD25 ^{High} CD8 ⁺	rs6850 PPIA	G vs A	0.2 ± 0.1	↑	0.0120	68
I ₀	IL-2 ⁺ CD4 ⁺	rs8177826 PPIA	G vs C	- 1.2 ± 0.6	↓	0.0190	41
	IL-2 ⁺ CD8 ⁺	rs72174030 PPP3R1	No Ins vs Ins	2.4 ± 0.6	↑	0.0080	66
	CD25 ^{High} CD4 ⁺	rs8177826 PPIA	G vs A	- 1.9 ± 0.3	↓	0.0006	83
IC ₅₀	NFAT1 ⁺ PBMC nuclei ⁺	rs141252617 FKBP1A	C vs A	1.6 ± 0.6	↑	0.0440	46
	IL-2 ⁺ CD4 ⁺	rs11594656 IL2RA	T vs A	2.0 ± 0.6	↑	0.0401	64
	IL-2 ⁺ CD8 ⁺	rs11594656 IL2RA	T vs A	1.9 ± 0.6	↑	0.0090	60
	CD25 ^{High} CD8 ⁺	Rs352285258 IL2RA	T vs C	1.4 ± 0.5	↑	0.0380	94
I _{max}	NFAT1 ⁺ PBMC nuclei ⁺	rs8177826 PPIA	G vs A	- 0.7 ± 0.3	↓	0.0045	35
	IL-2 ⁺ CD8 ⁺	rs11594656 IL2RA	T vs A	- 59 ± 25	↓	0.0430	52
	CD25 ^{High} CD4 ⁺	rs11594656 IL2RA	T vs A	2.6 ± 0.3	↑	0.0001	96

*Bonferroni correction relies on significance at $p < 0.0021$.



Another important finding of this study is the repeated, although diverse influence of *PPIA* 8177826G and *PPP3CA* 45441997 on tacrolimus pharmacodynamics in healthy volunteers and patients of the LT waiting list: the *PPIA* polymorphism downregulated NFAT1 IC₅₀ in HV and CD25^{High}CD4dim I₀ in WLP; *PPP3CA* upregulated IL-2⁺CD4⁺ I_{max} in HV and NFAT1⁺ in non stimulated PBMC nuclei⁺ in WLP. Interestingly, *IL2RA* haplotype (rs10795791, 11594656, 35285258), which in healthy volunteers upregulate T cell function in CD4⁺ and T cell activation, in WLP only the influence of *IL2RA* 11594656T allele upregulates T cell activation I max.

TAC I_{max} is mostly affected by the rs45441997 [(GGC)_{10/10}] SNP in the promoter region of the calcineurin catalytic subunit, where it is associated with increased T cell function and T cell activity in healthy volunteers, while in patients of the waiting list (GGC)_{8/8} variant downregulates T cell function under non stimulated condition.

Based on these results, it is clear that the influence of pharmacogenetics on tacrolimus pharmacodynamics in WLP is not the same as that in healthy subjects. All variants upregulate PD parameters apart from those of cyclophilin A on the expression of CD25 on CD4⁺ cells and NFAT1⁺ in PBMC nuclei and *IL2RA* in IL-2 in CD8⁺ T cell subset. Apparently, when *PPIA* is mutated a negative effect is seen on CD25^{High}CD4⁺. As *PPIA* promotes the assembly of calcineurin subunits, if it is less active, less NFAT will be dephosphorylated and consequently translocated to the nucleus for triggering gene expression.(2)

Tacrolimus physiological levels of the pharmacodynamic biomarkers studied here are influenced by polymorphisms of the promoter regions of the calcineurin catalytic subunit (rs149278688) and by cyclophilin A rs6850. The contribution of the variability of *PPP3CA* C149278688A allele to NFAT1 translocation is 77%.



However IL-2⁺CD8⁺ basal levels in stimulated conditions is favored by the absence of 29pb insertion in the promoter region of the calcineurin regulatory subunit, explaining 66% of the observed variability. As in physiological after polyclonal activation, a mutation in the promoter region of the cyclophilin A gene downregulates the expression of CD25^{High} on CD4⁺ cells, accounting for 83% of the inter-individual variability. Interestingly, two polymorphisms in the same promoter region exerted opposite effects, one enhancing CD25 expression in T lymphocytes and the other repressing this expression on T helper cells.

IC₅₀ of IL-2⁺CD4⁺ is positively affected by wild-type *IL2RA* polymorphism (rs11594656), which accounts for 64% of its variability. Similarly, the same SNP is responsible for 60% of the variability of IL-2⁺CD8⁺. *IL2RA* rs35285258 mutated allele also upregulates CD25 expression in cytotoxic T cells.

Tacrolimus maximal effect on CD25^{High}CD4⁺ seems to be influenced for 96% of the inter-individual differences by the *IL2RA* rs11594656 wild type allele.

This is the first time that all these relationships of BM between them and gene variants with BM are being reported.

One clear limitation of this study is the small number of patients of the liver transplant waiting list enrolled. However, the ex-vivo experiments are very long, cumbersome and costly and it is unlikely that a much larger patient group can be studied this way.

In brief, this research confirms the consistency of signal transduction along the calcineurin pathway, with increasing TAC dose requirements for inhibiting NFAT1 nuclear translocation up to IL-2 and CD25 expression, and PD curves fitting I/I_{max} models. Furthermore, this study also supports strong associations between TAC pharmacodynamic biomarkers and genetic variants in the genes encoding cyclophilin A, calcineurin catalytic subunit and CD25, as we previously found in healthy volunteers.



IV.4. LIVER TRANSPLANT PATIENTS TRANSVERSAL GROUP

We included 82 liver transplant patients in 3PIGREF. 10 were on cyclosporine, 2 were on mycophenolate mophetil only and one was tolerant and received no immunosuppressant.

IV.4.1. LIVER TRANSPLANT RECIPIENTS on TACROLIMUS (ARTICLE N°4 - DRAFT)

Title: Tacrolimus pharmacokinetics, pharmacodynamics and pharmacogenetics along the calcineurin pathway in Liver Transplant Recipients

Running Head: Tacrolimus PK, PD and PGx in liver transplantation

Authors:

Ofelia, M, Noceti^{1,2,3}

Patricia, Esperón³

Lucie, Pouché¹

Solange, Gerona²

Daniela, Lens⁶

Nicolas, Picard¹

Vital, Marcelo³

Cristina Touriño⁶

Jean-Baptiste, Woillard¹

Pierre, Marquet¹



Institutions and affiliations:

¹INSERM U850, Univ Limoges, CHU Limoges, France.

²Liver Diseases Department, National Center for Liver Transplantation, Hospital Central de las Fuerzas Armadas, Montevideo, Uruguay.

³Molecular Biology Unit, Clinical Biochemistry Department, School of Chemistry, Universidad de la República, Montevideo, Uruguay.

⁶Department of Fundamental Medicine, School of Medicine, Universidad de la República, Montevideo, Uruguay.

Corresponding author:

Prof. Pierre Marquet

INSERM U850, Laboratory of Medical Pharmacology

School of Medicine, Univ Limoges

2 rue du Dr. Marcland

87025 Limoges cedex

Phone: +33 555 05 60 17

Fax: +33 555 05 61 62

Email: pierre.marquet@unilim.fr

Keywords:

Liver transplantation; calcineurin inhibitors; tacrolimus pharmacodynamics.



Abbreviations:

APC, allophycocyanin; ATP, adenosine triphosphate; BM, biomarker; CaN (PP2B), calcineurin; CaNA, calcineurin activity; CNISs, calcineurin inhibitors; CO₂, carbon dioxide; CsA, cyclosporine; dim, diminished; FBS, fetal bovine serum; FCS, forward-scattered light; FITC, fluorescein isothiocyanate; I₀, physiological level of the biomarker in the absence of calcineurin inhibitor; I_{max}, maximal response induced by TAC; IC, immunological capacity; IC₅₀, half maximal inhibitory concentration; IL-2, interleukin 2; IL-2Rα (CD25), interleukin 2 receptor alpha subunit; LD, linkage disequilibrium; LTR, liver transplant recipients; MFI, mean fluorescence intensity; NFAT, nuclear factor of activation of T cells; NFAT1, isoform 1 of the nuclear factor of activated T-cells; NFATc2 (NFAT1), cytoplasmic 2 nuclear factor of activated T-cells; NS, non stimulated; PBMC, peripheral blood mononuclear cells; PD, pharmacodynamic; PE, phycoerythrin dye; PE-Cy7, phycoerythrin and cyanine dye; PerCP-Cy5.5, peridinin chlorophyll protein and cyanine dye; PMA, phorbol 12-myristate 13-acetate;; SSC, side-scattered light; TAC, tacrolimus.

Human Genes:

ABCB1: ATP-binding cassette, sub-family B (MDR), member 1.

PPIA: peptidylprolyl isomerase A (cyclophilin A).

PPP3R1: protein phosphatase 3, regulatory subunit B, alpha.

PPP3CA: protein phosphatase 3, catalytic subunit, alpha isozyme.

PPP3CB: protein phosphatase 3, catalytic subunit, beta isozyme.

FKBP1A: FK506 binding protein 1A, 12kDa.

CALM1: calmodulin 1 (phosphorylase kinase, delta).

CYP3A4 : cytochrome P450 3A4.

CYP3A5 : cytochrome P450 3A5.

IL2: interleukin-2.



IL2RA: *interleukin 2 receptor, alpha (IL-2R α , CD25).*

JUN: *jun proto-oncogene.*

NFATC1: *nuclear factor of activated T-cells, cytoplasmic, calcineurin-dependent 1 (NFAT2).*

NFATC2: *nuclear factor of activated T-cells, cytoplasmic, calcineurin-dependent 1 (NFAT1).*

ABSTRACT

BACKGROUND: Therapeutic drug monitoring is not always sufficient to compensate the large intra- and inter-individual variability of the immune response to immunosuppressants. We designed a study in liver transplant recipients (LTR) to investigate tacrolimus (TAC) pharmacodynamics (PD) along the calcineurin pathway and the sources of variability of PD biomarkers linked to lymphocyte T function and activation.

METHODS: 69 LTR grafted for 60 \pm 62 months and receiving tacrolimus alone or in combination with mycophenolate and/or prednisone, were enrolled in this study. PBMC were isolated from a whole blood sample collected before the TAC morning dose, incubated and stimulated ex vivo. Inhibition of NFAT1 translocation to the nucleus of PBMC, intracellular expression of IL-2 in CD4⁺ and CD8⁺ T cells, and expression of the surface activation marker CD25 on CD3⁺, CD4⁺ and CD8⁺ cells were measured by flow cytometry before (NS) and after stimulation (stim) ex vivo.

*The promoter regions of the genes encoding immunophilins and calcineurin subunits were investigated using Sanger sequencing, while Taqman[®] allelic discrimination assays were employed for selected SNPs in the genes of the calcineurin pathway and of the TAC metabolic enzymes CYP3A5, CYP3A*22 and efflux transporter ABCB1.*



RESULTS: The largest variability was found for unstimulated CD25^{High} CD3, IL-2⁺CD8⁺, CD25^{High}CD4⁺, while variability was moderate for the rest of the PD biomarkers in unstimulated conditions, with the exception of NFAT1⁺PBMC nuclei⁺ which was the lowest. Stimulated levels of IL-2⁺ and CD25High in CD8⁺ T cells showed the largest variability, while lower CV% values were found for CD25High in CD3⁺ and CD4⁺ T cells. Similar to physio-pharmacological findings, in stimulated conditions NFAT1 in PBMC nuclei exhibited the lowest variability. Moreover none of the PD biomarkers was completely inhibited, except IL-2⁺CD4⁺ in unstimulated conditions. Linear regression multivariate analysis with Bonferroni's correction for multiple testing was performed, but neither TAC whole blood concentrations, polymorphisms in CYP3A and ABCB1, nor polymorphisms in the genes encoding proteins of the cascade had a significant influence on TAC pharmacodynamic biomarkers, in either non-stimulated or stimulated conditions.

CONCLUSIONS: For the first time, tacrolimus pharmacodynamics over the whole calcineurin signaling pathway was investigated in LTR and the corresponding pharmacodynamic biomarkers measured in non-stimulated and stimulated conditions, meaning that a “physio-pharmacological” reading is possible without the introduction of mitogenic or polyclonal stimuli. These biomarkers displayed a large inter-individual variability in both NS and stim conditions, but were not influenced by TAC dose or trough blood levels, nor by a range of polymorphisms in the calcineurin pathway. Whether individual values are predictive of drug responses is the object of an on-going cohort study.

Keywords:

Liver transplantation; calcineurin inhibitors; tacrolimus pharmacodynamics.



INTRODUCTION

The huge intra- and inter-individual variability in drug effects observed in solid organ recipients, not explained by differences in calcineurin inhibitor (CNI) dose, trough concentration or even the area under the concentration-time curve (AUC), represents a limitation of therapeutic drug monitoring and suggests that other factors than drug exposure influence drug response. As over immunosuppression can lead to infection and cancer and under immunosuppression to graft rejection, the balance of this equation remains quite difficult to achieve. Besides, none of the usual clinical chemistry tests can predict or detect early the events related to over- or under-immunosuppression.

Histopathology is still the imperfect gold-standard to diagnose graft lesions, in particular acute and chronic rejection, but it is an invasive procedure for the patient with imprecision linked due to tissue sampling and the pathologist's expertise.

For the above mentioned reasons, better strategies for treatment optimization are therefore needed and which could include the identification and validation of pharmacodynamic biomarkers and direct measurement of drug concentrations at the target sites, i.e., allograft tissue and lymphocytes.(1)

In this respect, different biomarkers at the pharmacodynamic, genetic and proteomic levels,(3)(5)(6)(7)(8)(9)(126) have been proposed to predict the risk of transplant rejection events; but it has not been possible to validate BM, to obtain reproducible results in independent centers so far. In addition, in most of the cases the number of patients included in the studies was an issue, because it was not big enough to reach statistical significance. The International Association of Therapeutic Drug Monitoring and Clinical Toxicology, has been working on a consensus document based on the



available scientific evidence on which markers would be more appropriate for transplantation and under which conditions.

As rejection is a multifactorial phenomenon its early detection seems to require a panel of markers, rather than a precise indicator which probably would not be able to integrate the miscellaneous contributions to which it is subjected. Otherwise, genetic factors might condition individual responses.

The evidence compiled up to date in liver transplantation points towards a group of assays like: eosinophilia(10), calcineurin activity(11) , soluble TGF β 1(12), intracellular IL-2 and IFN γ expression in CD8⁺ T subset (12)(13), V δ 1⁺/V δ 2⁺ cells ratio (14), DSA and C4d (9)(15)(16), NFAT residual expression of regulated genes (17), micro RNAs (18)(19) and graft-derived cell-free DNA (20) as the most promising biomarkers to predict liver acute cellular rejection. Besides, NFAT residual expression of regulated genes (21)(22) and intracellular ATP in CD4⁺ T cells (3) would be both useful for the prediction of infection and the former also malignant processes. It is noteworthy that some of these markers have failed to prove their predictive utility in liver transplantation even if they have exhibited associations in renal grafts and even some have proven their diagnostic utility in combination rather than in isolation, since they can be expressed in other liver disorders. For liver transplantation DSA and C4d and CD4⁺ intracellular ATP determinations have been the most controversial.

As mentioned before pharmacodynamic biomarkers and direct measurement of drug concentrations at the target sites stands as a promising strategy which has begun to show certain advantages, such as the work of Capron et al. showed that diminished tacrolimus concentration in recipient's PBMC associates with clinical rejection.(1)



*As CNI are metabolized by CYP3A4 and CYP3A5 in the liver and in the intestine and are expelled from the cells by the P-glycoprotein (P-gp; ATP-binding cassette sub-family B member 1, ABCB1 encoding gene), in liver transplantation, recipient's intestinal genotype and donor's liver genotype may act together to contribute to overall drug disposition, hence the importance of assessing both to warn clinicians about CNI starting optimal doses (94). In this sense the exploration of donor-receptor polymorphisms in ABCB1, CYP3A4*22 and CYP3A5 genotypes although their prognostic value is still controversial*

(1)(94)(95)(96)(97)(99)(102)(104)(107)(108)(110)(112)(113)(117)(118)(120)(121), the authors consider assessing the influence of tacrolimus (TAC) pharmacokinetics determinants and their potential implications in TAC pharmacodynamics.

Taken into account the aforementioned evidence in order to find clues for the rational choice of BMs to monitor TAC immunosuppressive activity we conducted a research with the intention of better understanding the inter- and intra-individual variability in the pharmacodynamics of calcineurin inhibitors in liver transplant patients and exploring the potential pharmacogenetic sources of such variability.

MATERIALS AND METHODS

STUDY DESIGN AND SUBJECTS

3PIGREF is a non-interventional study approved by: the Scientific and Ethics Committee for Medical Research of the Hospital Central de las Fuerzas Armadas; the Ethics Committee of the School of Chemistry of the Universidad de la República (UdelaR); and the Uruguayan Directorate of Medical Technologies of Health of the Ministry of Health, in Montevideo, Uruguay. All investigations complied with the ICH guidelines for Good



Clinical Practice and Good Laboratory Practice and with the Declaration of Helsinki. The trial was registered on ClinicalTrials.gov with reference number: [NCT01760356](#).

Sixty nine patients (41 males and 28 females) who underwent liver transplantation were included after having given their written informed consent to participate in the study. They fulfilled the following protocol inclusion and non-inclusion criteria: being on tacrolimus without everolimus (or sirolimus) or azathioprine as comedication; not being retransplanted or having benefited from more than one graft, not having received treatment with immunosuppressant drugs, or interferon gamma at least six months before transplantation.

PHARMACODYNAMIC INVESTIGATIONS

As previously described 35 ml of blood were drawn in fasting conditions in sodium heparin vacutainer tubes (Becton Dickinson) and aliquots of 1×10^6 PBMC/ml were incubated ex-vivo at 37°C in a humidified atmosphere at 5% CO₂, permeabilized if required and stained with antibodies specific of each target for flow-cytometry analysis.(2) One aliquot of each sample was analyzed without mitogenic stimulus, while the duplicates were stimulated with PMA/I or ConA. NFAT1 translocation to PBMC nuclei, intracellular IL-2 expression in CD4⁺ and CD8⁺ T cells and IL-2R α expression at the surface of CD3⁺, CD4⁺ and CD8⁺ T cells were determined with a Beckton-Dickinson FACS CANTO II flow cytometer equipped with three lasers following Euroflow standardized guidelines (127), and data results analyzed using FlowJo Single Cell Analysis software, USA.



PHARMACOGENETIC INVESTIGATIONS

DNA was obtained from recipient's whole blood (2) while donor's DNA was extracted from serum through means of a kit from Macherey Nagel, Germany (NucleoSpin Plasma XS, ref. 740900)

Characterization of Gene Promoters

DNA was sequenced for the promoter region of PPIA, PPP3R1 and PPP3CA (coding for cyclophilin A, calcineurin regulatory subunit B α , calcineurin catalytic subunit α respectively) as previously described (2), whereas FK506 binding protein 1A was assessed by restriction fragment length polymorphism PCR analysis. (See Materials and Methods Section III.2.1.)

Polymorphisms in Pharmacogenes involved in TAC Pharmacodynamics

The polymorphisms studied were those found in the genes of the calcineurin pathway: CALM1 [calmodulin 1 (phosphorylase kinase, δ)] rs12885713; IL2 (interleukin-2) rs2069762; IL2RA (interleukin 2 receptor, α) rs7090530, rs10795791, rs11594656, rs35285258; JUN (jun proto-oncogene) rs2760501, rs4646999; and NFATC1 (nuclear factor of activated T-cells, cytoplasmic, calcineurin-dependent 1) rs754093, which were genotyped by means of Taqman[®] allelic discrimination assays. Designed customized assays were employed when required. (For further details, please see section III.2.2.)



Binding Sites Variants of NFAT1, NFAT2 and PPP3CA

To further explore whether potential polymorphisms located at critical sites of interaction between calcineurin and NFAT or with other proteins such calmodulin and AP1, and/or of NFAT phosphorylation/dephosphorylation sites that could influence the response to CNI, part of *NFAT1* and 2 and *PPP3CA* were sequenced.

NFAT gene was mapped through the structural motifs that could have potential interaction with calcineurin and other proteins required for gene transcription.

The variants identified in silico for *NFAT* were within the: serine rich region 1, serine repeat motif 3, serine rich region 2 and nuclear localization sequence and activator protein 1, all located in exon 2. For *PPP3CA*, they were in the region of interaction with CyPA and FKBP12 corresponding to exons 9 and 10 and with the autoinhibitory peptide domain in exons 11 and 14.

Reference sequences of each gene were loaded to Sequencher 4.8 DNA sequence analysis software (Gene Codes Corporation, USA) in order to locate into the amino acid sequence the critical regions of interaction depicted in the literature. From that point on, the corresponding DNA sequences were investigated.

PCR products of *PPP3CA* (exon 9, 10, 11 and 14) and *NFAT1* and *NFAT2* (exon 2) were sent to MacroGen Korea for sequencing. Primers were also provided by MacroGen (www.dna.macrogen.com). Fragments were purified in agarose gel 2% using Zymoclean™ Gel DNA Recovery Kit (D4001).



SNPs in Pharmacogenes involved in TAC Pharmacokinetics: ABCB1, CYP3A5 and CYP3A4*22

42 recipients and their respective donors were screened. ABCB1 MDR1, CYP3A5 and CYP3A4*22 variants were genotyped by means of Taqman® allelic discrimination assays. SNP assays were ordered from Applied Biosystems™ (ABCB1 C3435T ref C_7586657, C1236T ref C_7586662; G2677T ref C_11711720D; CYP3A5 ref C_26201809; CYP3A4*22 ref C_59013445). Because part of the included patients was transplanted in Argentina, only 42 donors could be screened for these SNPs.

STATISTICAL METHODS

Distribution normality was tested using the Shapiro-Wilk test and when needed, data were log-transformed.

The influence of gene polymorphisms was tested using R v2.15.1 (R foundation for statistical computing, <http://www.r-project.org>). Conformity of genotype distributions with the Hardy–Weinberg equilibrium was verified using the Fisher’s exact test with the “SNPassoc” package. We investigated linkage disequilibrium between rs72174030, rs4347819 and rs4519508 (PPP3R1, Chromosome 2) and between rs10795791, rs11594656 and rs35285258 (IL2RA, Chromosome 10) and the most probable haplotypes were inferred using the “haplo.stat” package.

A hierarchical model based on the different steps of the calcineurin pathway was conceived to study the influence of PK and PG characteristics on TAC pharmacodynamics; it was fed with covariables that we thought were the most pertinent at each step (Figure IV.1.4). Each stage took into account the variables of the upper levels, but not those from downstream, except for IL-2 and CD25 due to their positive auto-regulatory loop.

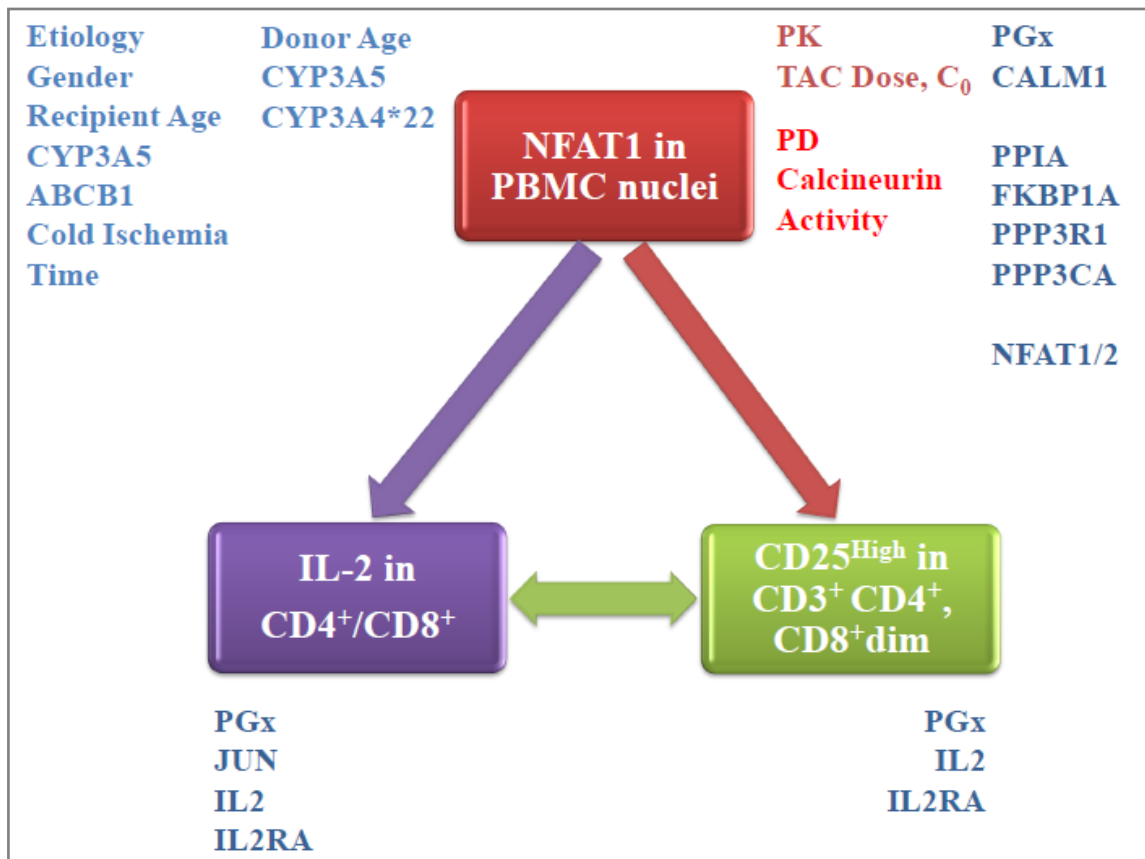

Figure IV.1.4. Diagram of PD biomarkers and covariates inflow. CD25 was gated to englobe the brightest expression in CD3, CD4 and CD8 diminished populations (shifted to the left; CD25^{High} in CD3dim, CD4dim and CD8dim).

The relations between SNPs or haplotypes and the respective pharmacodynamic biomarkers were investigated using multiple linear regression analysis. Univariate analysis was first performed and variables characterized by $p < 0.05$ were included in an intermediate model. The final model was selected using a backward stepwise process based on the likelihood ratio test. The Bonferroni correction was applied to the final model to account for multiple testing (5 multivariate tests for NS and 6 for stim conditions). The percentage of variability explained by each covariate or genetic variant in these final models was estimated using an ANOVA as the ratio of variability associated to the variable divided by the global variability (sum of the variability of each variable and of the residual variability).



RESULTS

The 3PIGREF clinical trial was analyzed in the intention-to-treat (ITT) approach. In this first analysis 69 recipients (42 males and 27 females) on tacrolimus, aged 44 (9-66) years at transplantation, were enrolled. None received everolimus, sirolimus or azathioprine as associated immunosuppressive drug, and all were in the fasting state at the time of blood sampling.

Patient characterization is summarized in Table IV.4.1 to 4.

Table IV.4.1. Indication for liver transplantation (n=69).

Indication	Description, concurrent disease and number of cases
Cirrhosis	Alcoholic (10); +HCC(2); +HCV(1); +HVC/HCC (1)
	Self-immune (7); +Kidney Liver Syndrome (1)
	HBV (3); +HCC (1); +HCV (4)
	HCV/HCC (2)
	Liver Syndrome (1)
	Cryptogenetic (5)
	NASH (2)
	Hemochromatosis (2)
	Primary Biliary (3); + Self Immune (2)
	Secondary Biliary (3)
Primary Sclerosing Cholangitis	+ Ulcerative Colitis (3); + HCV (1)
Cholestasis	n=1
Acute Liver Failure	n=1; + HAV (1)
Budd Chiari Syndrome	n=1
Giant Hemangiome	n=1
Wilson's Disease	n=1
Kidney Liver Failure Acute on Chronic	n=1



Table IV.4.2. Demographic characteristics of liver transplant patients at enrollment.

Characteristic	Values
Donor Age (years)	31 (12 - 61)
Cold ischemia time (h)	5.5 (3.0 – 11)
Basiliximab Induction (n)	16
Recipient Gender	41 men, 28 women
Recipient Age at Transplantation (years)	44 (9 - 66)
Post Transplantation time of enrollment (days)	1488 (2 - 6840)
Bodyweight (Kg)	72 (34 -151)
CMV Status (R/D) (n)	-/- (16); +/- (10); +/+ (37);-/+ (7)
EBV Status (n)	+ (30); - (8); ND (32)
Renal Dysfunction (n) (SCr \geq 1,3mg/dl and GFR decrease more than 25, 50 or 75%, RIFLE)	2 males: Chronic Kidney Disease and 1Hepatorenal Syndrome Type II; International Ascites Club Criteria (IAC 2011)
Type 1 or 2 Diabetes (n) (Glycemia>1.10 mg/dL)	11
Chronic Ulcerative Colitis (n)	5
Hematocrit (%)	37 (15 - 58)
WBC ($10^3/\mu$ l)	6.3 (2.4 - 22)
Lymphocytes (%)	25 (3.0 - 66)
Serum Creatinine (mg/dl)	1.0 (0.4 - 2.1)
Estimated GFR (Cockcroft-Gault) (ml/min)	87 (25 - 144)
Total Bilirubin (mg/dl)	0.8 (0.2 - 4.6)
ASAT (U/l)	33 (9 - 266)
ALAT (U/l)	46 (7 – 531)
GGT (U/l)	62 (9 - 515)
Alkaline Phosphatase (U/l)	192 (9 - 808)



Table IV.4.3. Immunosuppressive drugs received at the time of PD monitoring.

IMS Drugs at enrollment	Number of cases
TAC only (n)	7
Tacrolimus daily dose (mg)	6.2 (1.0 - 11)
Tacrolimus C ₀ (ng/ml)	7.5 (1.0 – 20.8)
TAC + MMF/MPA (n)	28
MMF/MPS (equivalent MPS dose, mg)	670 (360 - 1800)
TAC + Corticoids (n)	10
Corticoids (mg)	6.3 (0 - 125)
TAC + MMF/MPA + Corticoids (n)	22
Stop to CNIS drugs	3
Switch to EVE post PD monitoring	7



Table IV.4.4. Post –transplantation adverse events (n=69).

Post-transplantation Adverse Events	Occurrence; Number of cases
Patients with Infections	44
Infection, number of episodes (n)	63
Number of infections /per patient	1.4
Infection show off (days)	(1 – 4966) days
Fungi Infections	5
Viral Infections	13
Bacterial Infections	44
Infections during the 1 st . week; n=patients	1.8 days (1 - 7); n = 14
Infections up to the 1 st . month; n=patients	9.6 days (1 - 31); n = 20
Infections up to the 3 rd . month; n=patients	18 days (1 - 69); n = 25
Infections up to the 1 st year; n=patients	55 days (1 - 355); n = 29
Patients with CMV Disease (n)	23
CMV Disease during the 1 st month (days); n=patients	24 days (9 - 31); n = 6
CMV Disease up to the 3 rd . month (days); n=patients	45 days (9 - 90); n= 16
CMV Disease up to the 1st. year (days); n=patients	79 days (9 - 365); n= 20
Neurotoxicity; n=patients	670 days (1 - 3629); n= 10
Nephrotoxicity; n=patients	310 days; n = 1
Neuro + Nephrotoxicity (days); n=patients	13 days (1 - 25) Tx; n = 2
Arterial Hypertension Post Tx (days); n=patients	893 days (1 - 4171); n = 7
NOD up to 1st month (days); n=patients	8 (1 - 29); n = 12
NOD after the 1 st year (days) ; n=patients	0
Retransplantation (days); n=patients	3491; n = 1
Acute Kidney Injury*(days); n=patients	349 (1- 696); n=16
Acute Kidney Injury*up 2 weeks (days); n=patients	3.5 days (1 - 10); n=11
Acute Kidney Injury*up 1 year (days); n=patients	183 days (1 - 365); n=14
Acute Kidney Injury*after 1 year (days); n=patients	544 days (391 - 696); n= 2
Cancer development (days); n=patients	2783 days (1091 - 4475); n= 2
Death (days); n=patients	2942 days (1259 - 4625); n= 2

* Criteria SCr \geq 1.3 mg/dl



PHARMACODYNAMIC PARAMETERS AND VARIABILITY

In Table IV.4.5 are presented the results of tacrolimus pharmacodynamics and their variability.

Table IV.4.5. Physiological levels (NS, without ex-vivo stimulation) and immunological reserve capacity (after ex-vivo stimulation) of PD biomarkers along the calcineurin pathway and variability of the response to tacrolimus effect.

PD Biomarker	Mean (Range)	CV %
NFAT1 NS (MFI)	205 (13 - 731)	13
NFAT1 (MFI)	349 (32 - 1212)	13
IL-2 ⁺ CD4 ⁺ NS (%)	0.1 (0.1 - 0.9)	24
IL-2 ⁺ CD4 ⁺ (%)	35 (3.4 - 67)	16
IL-2 ⁺ CD8 ⁺ NS (%)	10 (0.1 - 66)	441
IL-2 ⁺ CD8 ⁺ (%)	7.0 (0.1 - 87)	83
CD25 ^{High} CD3dim NS (%)	1.2 (0.1 - 4.5)	523
CD25 ^{High} CD3dim (%)	13 (0.4 - 44)	40
CD25 ^{High} CD4dim NS (%)	1.9 (0.1 - 5.8)	301
CD25 ^{High} CD4dim (%)	15 (1.1 - 56)	34
CD25 ^{High} CD8dim NS (%)	0.1 (0.1 - 1.4)	21
CD25 ^{High} CD8dim (%)	7.6 (0.1 - 38)	94

The unstimulated levels of NFAT1 in PBMC nuclei (10- fold range), intracellular IL-2 in CD4⁺ T cell subset and for CD25 expression in CD8⁺ T cells (20-fold range), exhibited mild to moderate interindividual variability, whereas variability in IL-2 expression in CD8⁺ T subset (400-fold), CD25 in CD4⁺ (300-fold) and CD3⁺ (500-fold) T cells was very large.



In comparison, the interindividual variability of stimulated markers was lower, except for CD25 and IL-2 in CD8⁺ T cells (100-fold).

The stim:Non Stim median ratios are: 1.7 for NFAT1⁺PBMC nuclei⁺, 350 for IL-2⁺CD4⁺, 0.7 for IL-2⁺CD8⁺, 11 for CD25^{High}CD3dim, 8 for CD25^{High}CD4dim and 76 for CD25^{High}CD8dim. (Figure IV.4.5.)

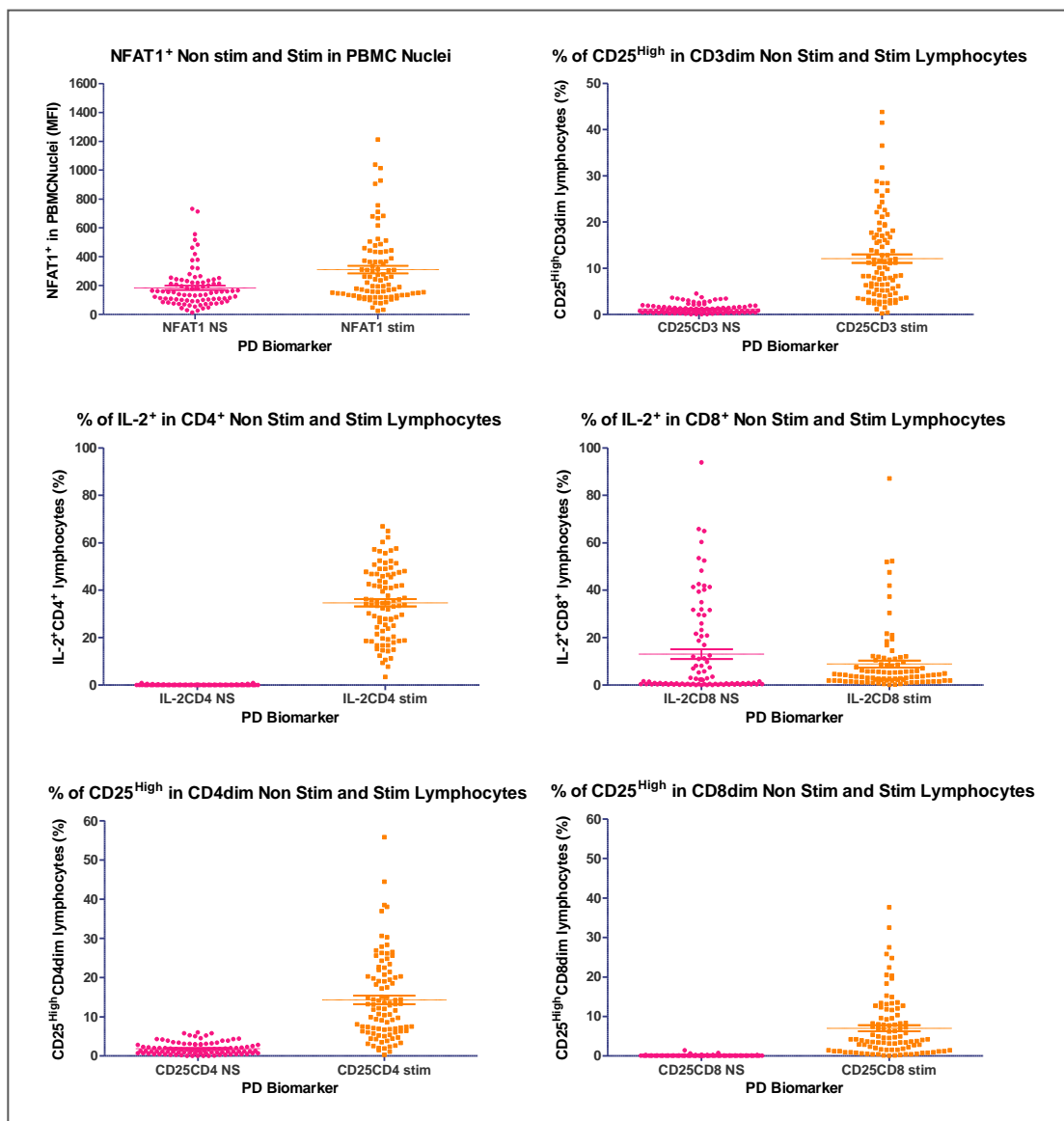

Figure IV.4.5. Pharmacodynamic biomarkers expression in non-stimulated and stimulated conditions.



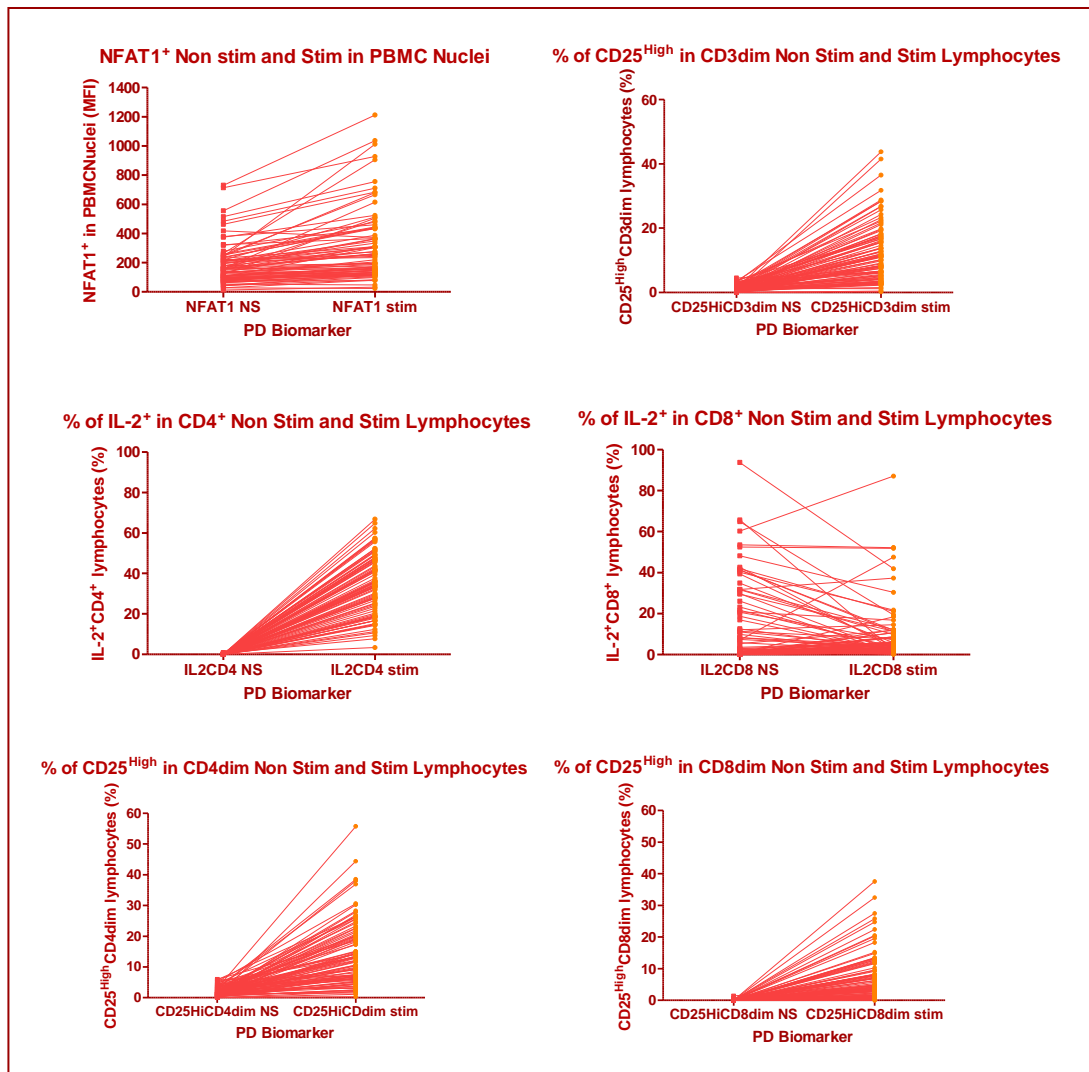

Figure IV.4.6. Intraindividual pharmacodynamic biomarker expression before and after mitogenic stimulation.

Multivariate analysis (Tables IV.4.6.1 and 2) revealed that no covariate was significantly associated with NFAT1 translocation in PBMC nuclei, either without or after 30min stimulation with PMA/I. In contrast, IL-2 expression in CD4⁺ cells after PMA/I stimulation was downregulated by the mutated allele of the promoter region of cyclophilin A and upregulated by CD25^{High} in CD8⁺ cells. Also, physio-pharmacological levels of IL-2 in CD8⁺ increased with CD25^{High} in CD8⁺ in non-stimulated T cells, while in stimulated conditions they were upregulated in ABCB1 rs1128503 wild-type carriers and downregulated in IL2RA rs11594656 wild-type carriers. CD25^{High} increased with recipient age in non-



stimulated CD4⁺ T lymphocytes, and with pre-transplantation HCC in CD8⁺ T cells, However, physiopharmacological levels of CD25^{High} in CD4⁺ showed no association with any of the parameters tested, while after mitogenic activation it was positively associated with IL-2 expression in CD4⁺ T cells.

PHARMACOGENETIC-PHARMACODYNAMIC RELATIONSHIPS

Statistical associations after Bonferroni correction between genetic variants and PD biomarkers measured in either unstimulated or stimulated conditions (NFAT1⁺PBMC nuclei, IL-2⁺CD4⁺, IL-2⁺CD8⁺, CD25^{High}CD3dim, CD25^{High}CD4dim, CD25^{High}CD8dim) are summarized in Tables IV.4.6.1 and 2. Tables IV.4.7.1 and 2 show covariate contribution analysis to tacrolimus pharmacodynamic phenotypes.

Table IV.4.6.1. Covariate association with tacrolimus PD biomarkers in non-stimulated conditions.

PD biomarker	Associated parameter	Genetic Model	$\beta \pm SD$ (Multivariate Model)	Modulation	p value* (Multivariate Model)
IL-2 in CD8⁺ NS	CD25^{High}CD8⁺ NS	NA	27 ± 12	↑	0.024
CD25^{High}CD3⁺ NS	Recipient Age	NA	0.019 ± 0.008	↑	0.025
	NFAT1 in PBMC⁺ NS	NA	0.0022 ± 0.0009	↑	0.015
CD25^{High}CD4⁺ NS	Recipient Age	NA	0.027 ± 0.013	↑	0.037
CD25^{High}CD8⁺ NS	HCC	NA	0.13 ± 0.06	↑	0.034

*Values in bold are significant at p<0.05 for multivariate models and p<0.010 after Bonferroni's correction.



Table IV.4.6.2. Covariate association with tacrolimus PD biomarkers in stimulated conditions.

PD biomarker	Associated parameter	Genetic Model	$\beta \pm SD$ (Multivariate Model)	Modulation	p value* (Multivariate Model)
IL-2 in CD4⁺ stim	rs6850 PPIA	G vs A	- 0.9 ± 0.4	↓	0.021
	CD25 ^{High} CD8 ⁺ stim	NA	0.019 ± 0.009	↑	0.049
IL-2 in CD8⁺ stim	rs1128503 ABCB1	T vs C	0.9 ± 0.4	↑	0.039
	rs11594656 IL2RA	T vs A	- 1.0 ± 0.5	↓	0.029
CD25^{High} in CD8⁺ stim	IL-2 in CD4 ⁺ stim	NA	0.02 ± 0.01	↑	0.010

*Values in bold are significant at p<0.05 for multivariate models and p<0.008 after Bonferroni's correction.

Tables IV.4.7.1 and 2 show contributions to TAC PD variability of non-stimulated and stimulated levels. The highest contributions are that of NFAT1 in PBMC nuclei on physiopharmacological levels of CD25^{High} in CD3⁺ T cells, and of the ABCB1 rs1128503 wild-type allele on IL-2 expression in stimulated CD8⁺ T cells.



Table IV.4.7.1. Contribution of covariates to the variability of TAC PD biomarkers in non-stimulated conditions.

PD biomarker	Associated parameter	$\beta \pm SD$ (Multivariate Model)	Modulation	p value* (Multivariate Model)	Variability Contribution (%)
IL-2 in CD8⁺ NS	CD25^{High} CD8⁺ NS	27 ± 12	↑	0.024	7.7
CD25^{High} CD3⁺ NS	Recipient Age	0.019 ± 0.008	↑	0.025	8.3
	NFAT1 in PBMC NS	0.0022 ± 0.0009	↑	0.015	12
CD25^{High} CD4⁺ NS	Recipient Age	0.027 ± 0.013	↑	0.037	7.8
CD25^{High} CD8⁺ NS	HCC	0.13 ± 0.06	↑	0.034	3.5

*Values in bold are significant at p<0.05 for multivariate models and p<0.010 after Bonferroni's correction.

Table IV.4.7.2. Contribution of covariates to the variability of TAC PD biomarkers in stimulated conditions.

PD biomarker	Associated parameter	$\beta \pm SD$ (Multivariate Model)	Modulation	p value* (Multivariate Model)	Variability Contribution (%)
IL-2 in CD4⁺ stim	rs6850GG PPIA	- 0.9 ± 0.4	↓	0.021	10
	CD25^{High} CD8⁺ stim	0.019 ± 0.009	↑	0.049	7.6
IL-2 in CD8⁺ stim	rs1128503TT ABCB1	0.9 ± 0.4	↑	0.039	12
	rs11594656TT IL2RA	- 1.0 ± 0.5	↓	0.029	9.9
CD25^{High} in CD8⁺ stim	IL-2 in CD4 ⁺ stim	0.02 ± 0.01	↑	0.010	10

*Values in bold are significant at p<0.05 for multivariate models and p<0.008 after Bonferroni's correction.



DISCUSSION

The aim of this ex vivo study in PBMC of liver transplant patients on tacrolimus was to assess inter-patient variability of TAC pharmacodynamic biomarkers as well as the influence of covariates such as determined by patient characteristics, TAC exposure and genetic polymorphisms.

Furthermore, our research includes the “therapeutic” unstimulated expression (“pharmacophysiological values”) of PD biomarkers of this cascade (which may provide a more realistic insight into in-vivo CNI pharmacodynamics in treated patient), as well as the respective measurements after mitogenic stimulation, which may better reflect the individual immunological reserve capacity under immunosuppression.

No relevant influence due to recipient – donor PK-related genetic characteristics resulted from our cause-effect modeling. TAC levels in whole blood cells may differ from intralymphocyte levels during rejection episodes.

“Physiological BMs” exhibit mild to moderate inter-individual variability as in the case of NFAT1 in PBMC nuclei, intracellular IL-2 in CD4⁺ T cell subset and CD25 expression in CD4⁺ T cells, whereas considerable variability was shown for IL-2 in CD8⁺ T cell subset and CD25 expression in CD4⁺ and CD3⁺ T cells.

Under stimulated conditions, inter-individual variability of the phenotypes resulted identical as in the case of NFAT1, and lower for the rest of the parameters, with the exception of CD25 expression in CD8⁺ T cells. Probably NS measurements integrate much more variance than the corresponding stimulated parameters, and this observation may obey to normalizing effect of mitogenic stimulus on lymphocytes.



A comparison of physiological inter-individual variability among liver transplant recipients and patients of the waiting list for liver transplantation (WLT) (Noceti et al, data not published) leads to practically the same values for NFAT1 in PBMC nuclei, 0.6-fold less for IL-2 in CD4⁺, 0.2-fold less for CD25 in CD8⁺ T cells subset; however 1.3-fold larger for IL-2 in CD8⁺ T cells, 6.4-fold greater for CD25 in CD3⁺ and 2-fold more for CD25 in CD4⁺ T cell subsets. Physiological measurements juxtaposition of the same groups exhibit NFAT1 reading 1.6-fold upper, IL-2 in CD4⁺ T cells remains equally, while the rest of the markers stay below (IL-2 in CD8⁺ is 0.6-fold, CD25 in CD3⁺ is 0.5-fold, CD25 in CD4⁺ is 0.6-fold and CD25 in CD8⁺ 0.25-fold.)

Analogous collation was done for stimulated values. Inter-individual variability of residual expressions of tacrolimus through level concentrations in the liver transplant group was contrasted to the coefficients of variation (CV) yielded from tacrolimus maximal inhibition effect in WLT (I_{max}). NFAT1 in PBMC nuclei is 0.15-fold and IL-2 in CD4⁺ T cell subset 0.1-fold minus, equally for CD25 in CD4⁺ T cells, while for the other markers is over (1.4-fold for IL-2 in CD8⁺, 2-fold for CD25 in CD3⁺ and 2.6-fold for CD25 in CD8⁺ T cell subsets.) PD readings analysis showed that only NFAT1 (5.3-fold) and IL-2 in CD4⁺ subset (39-fold) were higher, while the rest lasted below (0.3-fold for IL-2 in CD8⁺; 0.3-fold for CD25 in T lymphocytes; 0.4-fold for CD25 in CD4⁺ and 0.2-fold for CD25 in CD8⁺ T cell subset), showing the same pattern of physiological levels. Phenotypes ratio among stimulated and physiological conditions varies in 1.7-fold range for NFAT1⁺ in PBMC nuclei⁺, 350-fold for IL-2⁺CD4⁺, 0.7-fold for IL-2⁺CD8⁺, 11-fold for CD25⁺CD3⁺, 8-fold for CD25⁺CD4⁺ and 76-fold for CD25⁺CD8⁺. Stimulation condition significant effect is seen mainly in IL2⁺CD4⁺ and CD25⁺CD8⁺ T cell subsets.



NFAT1 controls the transcription of genes involved in different homeostatic processes, including IL2 and CD25, and it has the capacity to integrate calcium/calmodulin/calcineurin and other signaling pathways. We previously showed in healthy volunteers and patients of the waiting list for liver transplantation tight signal translation along the calcineurin/NFAT pathway and found that IL-2 and CD25 in T cells followed an allosteric sigmoid model obeying to NFAT1 translocation to PBMC nuclei. Similar to NFAT1 and contrary to IL-2, CD25 expression in T cells was not completely inhibited by tacrolimus.(2) However, in our group of liver transplant recipients we observed that none of the residual expression levels of these biomarkers is completely inhibited. On the other hand, IL-2 synthesis by Th1 cells is quite elevated reaching the same values as in healthy volunteers, which may be pointing out the existence of an activated/inflammatory status maybe owing to an immunological conflict between the recipient and his/her graft, despite the action of immunosuppressive therapy. Contrarily, IL-2 expression in cytotoxic T lymphocytes remains low, while CD25 levels show mild expression, 3-fold less than healthy volunteers I_{max} . It could be speculated as IL-2 and CD25 form a positive auto-regulatory loop, that CD25 expression captures the excreted IL-2, forcing T cells to produce more cytokine, and consequently inducing CD25 more (auto-regulatory loop). To maintain effective immune response, T cell proliferation and cell cycle progression, a threshold must be overcome. In the conditions of our research, low CD25 values may indicate reduced T cell activation, despite increased IL-2 levels. Moreover, low CD25 levels may impair IL-2 biological effects somehow.



These results are consistent with those of Canivet et al. in patients on the waiting list of liver transplantation, whose intracellular cytokine expression in mitogen-stimulated T cells was higher than in healthy volunteers; whereas the expression of T cell activation markers was downregulated in patients with liver cirrhosis compared to healthy volunteers.(26) Whether the persistence of IL-2 and/or CD25 in these cell subsets in certain patients may translate into different clinical outcome is the object of the ongoing, longitudinal follow-up of these patients.

Positive and negative regulators network of calcineurin pathway in tacrolimus pharmacodynamics are illustrated in Figure IV.4.5. However, after Bonferroni's correction ($p=0.05/6=0.008$), no significant association was found.

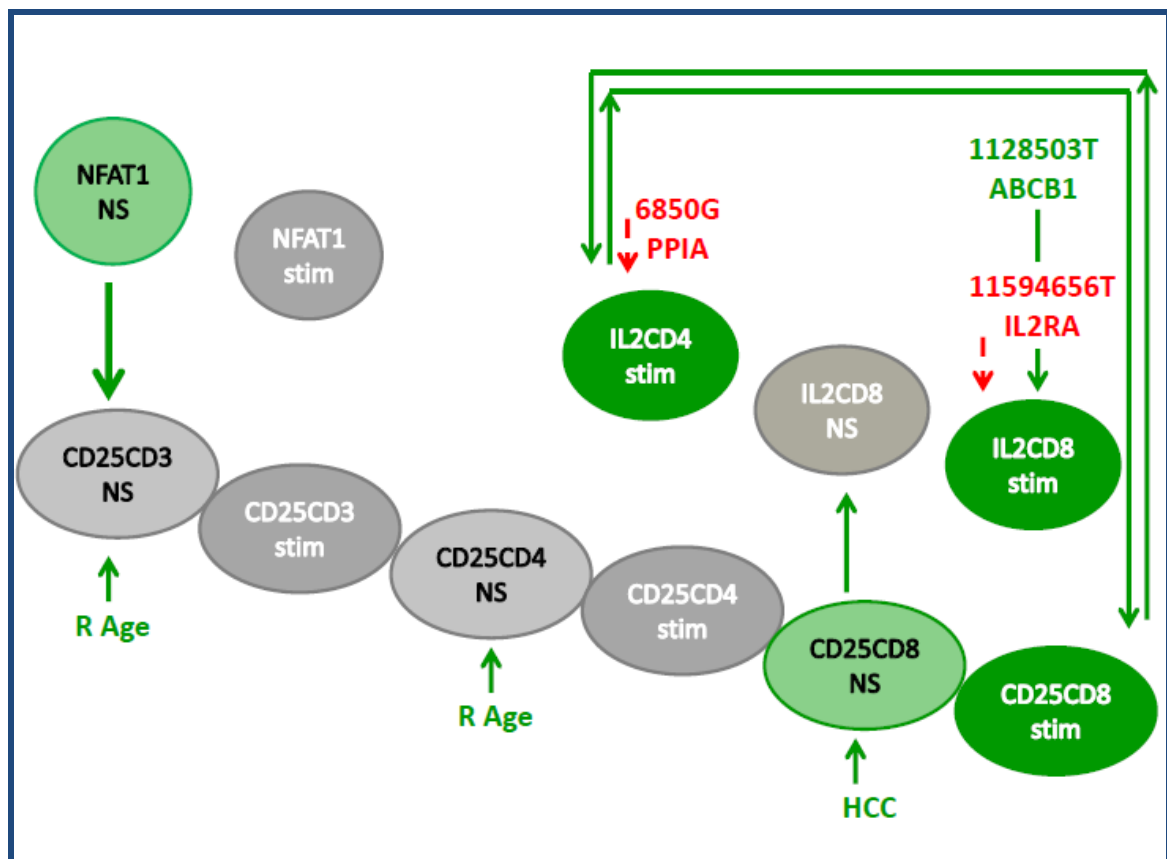

Figure IV.4.7. Positive and negative regulators of tacrolimus PD.

Green and red dotted arrows denote up and downregulation of their targets respectively. Phenotypes represented by grey ellipses did not show relationships with their partners in the pathway. Green ellipses mean positive and negative regulation respectively. (*) means significant values after Bonferroni correction



NFAT-dependent gene expression responds to the calcium/calmodulin/calcineurin signal, but polyclonal stimuli may mimic TCR and coreceptor signals (128), or as in the case of concanavalin A, activate phospholipase C via Gα protein leading also to the inositol triphosphate (IP3) pathway, cross-linking TCR (129). Such differences in activation of pathways may imply a more pervasive involvement of calcineurin subunits during the activation process. No factor seems to act upon NFAT1 levels in PBMC nuclei, whether stimulated or not.

Stimulated IL-2⁺CD4⁺ cells expression enhances CD25^{High}CD8⁺ stim cells and viceversa.

These relationships are possible due to the positive auto-regulatory loop concerted between IL-2 and its α-chain receptor and due to Th1 cells assistance (priming) to cytotoxic T cells.

IL-2 signaling influences CD8⁺ T cells at all stages of the immune response.

Besides CD4⁺ Thelper cell regulation of CD8⁺ responses, CD8⁺ T cells depend on autocrine IL-2 production. Indeed, the differentiation of CD8⁺ naïve T cells is affected by the strength and duration of IL-2 signals during a primary and secondary immune response.(85)

CD25^{High} before or after mitogenic stimulation may be subject of further regulation. In unstimulated conditions, multivariate analysis showed that CD25^{High} in CD3⁺ and CD4⁺ were significantly enhanced in older patients, highlighting a more activated state of the lymphocytes in these recipients. On the other hand, CD25^{High}CD4⁺ expression encloses Tregs cells, which localize in the upper segment of this gated population. The role of Tregs is to suppress autoimmunity even though they are not effector cells; In addition of



being $CD25^{High} CD4^{+}$ cells, Tregs are defined by their positivity for FOXP3, whose activity is controlled by NFAT and SMAD factors.(68)

$CD8^{+}$ and NKT cells act synergistically to promote hepatocellular carcinoma through interactions with hepatocytes, via NF- κ B signaling.(130) $CD8^{+}$ T cell subset once activated ($CD25^{High}CD8^{+}$) directs the lysis of tumour cells, contributing to liver tissue remodeling.(131) Local T cell activation increases the secretion of tumor necrosis factor-alpha (TNF α) by $CD8^{+}$ T cells and interleukin 17 (IL-17) by $CD4^{+}$ T cells.(130) Interestingly, in our scenario the pharmacophysiological synthesis of $CD25^{High}CD8^{+}$ T cells is enhanced by HCC recipient's pre-transplantation condition, in line with cytotoxic cells and HCC association. Indeed, cancer induces a systemic immunological response capable of modulating pharmacodynamic responses. This $CD25^{High}CD8^{+}$ subset also includes $CD8^{+}$ Tregs.

Although Tregs are not effector T cells, T cell proliferation and IFN γ production by $CD4^{+}$ effector T cells are both repressed by $CD4^{+}$ and $CD8^{+}$ Tregs. Nevertheless, in vitro $CD8^{+}$ Tregs cells are more potent regulators than $CD4^{+}$ Tregs and have the capacity to inhibit IL-17 expression.

Bohler et al. have shown that the donor's and the recipient's age influence graft survival, owing to different functional changes in white blood cells which may be partially responsible for cellular and humoral immunodeficiencies in the elderly. They postulated that age exerts an influence on specific T cell functions (assessed by IL-2 expression) and the increase of pro-inflammatory cytokine expression with age would affect allograft survival. Moreover, in transplant patients $CD25^{High}$ activated T cells and age may upregulate T cell proliferation in response to IL-2.(132)



Indeed, our linear regression analysis results show that recipient age is positively associated with unstimulated CD25^{High} expression in CD3⁺ and in CD4⁺ T cells, but we do not observe downregulation of cytokine expression in Th1 cells exhibiting by this larger lymphocyte activation.

After Bonferroni's correction, most of the covariates that potentially influence TAC pharmacodynamics were not significant any more, probably due to not enough patients or too many tests. However, multivariate analysis confirmed several previously reported findings and revealed new ones. These latter results should be considered as preliminary owing to the rather limited number of patients studied, some of whom were on corticoids and mycophenolate and others had received basiliximab induction therapy that may interfere with TAC pharmacodynamics [especially with CD25, causing its downregulation (133)]. An on-going longitudinal study will help verifying these observations.

To the best of our knowledge, this is the first study where the different levels of the calcineurin /NFAT signaling pathway are explored simultaneously in transplant patients on tacrolimus. Moreover, we are presenting differences between 'therapeutic', unstimulated expression of the biomarkers of this cascade (which may provide a more realistic insight into in-vivo CNI pharmacodynamics in treated patient), and the respective measurements after mitogenic stimulation, which may better reflect the individual immunological reserve capacity under immunosuppression. No pharmacogene had a significant influence on tacrolimus pharmacodynamics after Bonferroni's correction, which may suggest that pharmacodynamic parameters are the pivotal factors of clinical outcomes.



Acknowledgements: *This work was supported by INSERM U850 Limoges, France; a PhD Scholarship of the Agencia Nacional de Investigación e Innovación, the French Scientific Cooperation Program, Uruguay, ECOS Sud Cooperation Program, the School of Chemistry and PEDECIBA, Uruguay.*

We also thank the Institute of Clinical Molecular Biology in Kiel for providing Sanger sequencing as supported in part by the DFG Cluster of Excellence “Inflammation at Interfaces” and “Future Ocean”. We thank the technicians S. Greve, S. Arndt and T. Henke for technical support.

We are also very grateful to Jean-Hervé Compte, Gonzalo Maldonado and Virginia Suaya for their continuous willingness to collaborate to this research.

References *(Please see general references)*



INTRODUCTION

Several studies have suggested differences between tacrolimus and cyclosporine pharmacodynamics (98)(134). In fact both drugs are calcineurin inhibitors, but they are structurally different, they bind different cytoplasmic immunophilins and the resulting complexes bind calcineurin at close but distinct sites to exert their inhibitory effect.(47) Moreover, the pattern and severity of their side effects are not strictly identical. The aim of the present study was to further explore cyclosporine pharmacodynamics in liver transplant recipients and compare it with that of tacrolimus.

The materials and methods employed are the same as in our previous study in LTR on tacrolimus.

RESULTS

The 3PIGREF clinical trial was analyzed in the intention-to-treat (ITT) approach. In this first analysis 10 liver transplant recipients (6 males and 4 females) on cyclosporine, aged 45 (5-63) years at transplantation, were enrolled. None received everolimus, sirolimus or azathioprine as associated immunosuppressant, and all were in the fasting state at the time of blood sampling.

Patient characteristics are summarized in Tables IV.2.1 to 4.



Table IV.4.2.1. Indications for liver transplantation (n=10).

Indication	Description, concurrent disease and number of cases
Cirrhosis	Alcoholic (2); Alcoholic +HCC(1)
	+HCC (1)
	Cryptogenetic (1)
	Hemochromatosis +HCC (1)
	Primary Biliary (1)
	Secondary Biliary (2)
	+ HCV (1)
Acute Liver Failure	+ VHA (1)

*NA not available before year 2009.

Table IV.4.2.2. Demographic characteristics of liver transplant patients at enrollment (n=10).

Characteristic	Values
Donor Age (years)	23 (15 - 27); 6 NA
Cold ischemia time (h)	5.45 (4.45 – 7.0); 6 NA
Basiliximab Induction (n)	1; 6 NA
Gender	6 men, 4 women
Age at Transplantation (years)	45 (5 - 63)
Post Transplantation time of enrolment (days)	3389 (15 - 8937)
Mass at enrollment (Kg)	79 (59 - 120)
CMV Status (R/D) (n)	-/- (3); +/- (2); +/+ (2); NA (3)*
EBV Status (n)	+ (4); NA (6)
Acute Injury or Chronic Kidney Disease (SCr \geq 1,3 mg/dl and RIFLE Criteria)	0
Type 2 Diabetes (n) (Glycemia>1.10 mg/dl)	2
Hematocrit (%)	41 (34 - 49)
WBC ($10^3/\mu$ l)	7.8 (4.2 – 14.4)
Lymphocytes (%)	23 (3.3 - 32)
Serum Creatinine (mg/dl)	0.9 (0.6 - 1.4)
Estimated GFR (Cockroft -Gault) (ml/min)	91 (53 - 117)
Total Bilirubine (mg/dl)	0.8 (0.3 – 1.7)
ASAT (U/l)	27 (19 - 42)
ALAT (U/l)	38 (15 – 93)
GGT (U/l)	59 (16 - 148)
Alkaline Phosphatase (U/l)	231 (62 - 387)

*NA not available before year 2009.



Table IV.4.2.3 Immunosuppressive drugs received at the time of PD monitoring.

IS Drugs at enrollment	Number of patients or Mean (range)
CsA only (n)	1
CsA + MMF/MPA (n)	4
CsA + Corticoids (n)	1
CsA + MMF/MPA + Corticoids (n)	4
Switch to EVE after PD monitoring	2
Cyclosporine daily dose (mg)	210 (100 - 500)
Cyclosporine C ₀ (ng/ml)	89 (59 – 164)
Cyclosporine C ₂ (ng/ml)	581 (332 – 951)
MMF/MPS (equivalent MPS dose, mg)	990 (720 – 1080)
Corticoesteroid dose (mg)	10

Table IV.4.2.4. Post –transplantation adverse events (n=10).

Post-transplantation Adverse Events	Time of occurrence, Number of cases
Death (days); n=patients	0
Retransplantation (days); n=patients	0
Cancer occurrence (days); n=patients	3433 days (1680 - 4676); n=3
Number of Patients with Infections	6
Infections, Number of Episodes	13
Infections per patient	1.3
Infection, time of occurrence	755 days (161 – 4004)
Fungi Infections	1
Viral Infections	3
Bacterial Infections	9
Infections during the 1 st week; n=patients	0
Infections within the first 6 months; n=patients	171 days (161 - 181); n = 2
Infections up to the 1 st year; n=patients	221 days (161 - 329); n = 4
Patients with CMV Disease (n)	0
Neurotoxicity; n=patients	67 days; n = 1
Nephrotoxicity; n=patients	0
Post-Tx Arterial Hypertension (days); n=patients	450 days; n = 1
NOD within the 1st month (days); n=patients	1 day; n = 1
NOD after the 1 st year (days) ; n=patients	0
Acute Kidney Injury* (days); n=patients	19 (1- 36); n = 2
Acute Kidney Injury*after 1 year (days); n=patients	0

*SCr ≥ 1.3 mg/dl



PHARMACODYNAMIC PARAMETERS AND VARIABILITY

In Table IV.4.2.5 are presented the results of cyclosporine pharmacodynamics and their variability.

Table IV.4.2.5. Physiological levels (NS, without ex-vivo stimulation) and immunological reserve capacity (after ex-vivo stimulation) of PD biomarkers along the calcineurin pathway and variability of the response to cyclosporine effect.

PD Biomarker	Mean (Range)	CV %
NFAT1 NS (MFI)	285 (90 - 773)	15
NFAT1 (MFI)	458 (120 - 1066)	16
IL-2 ⁺ CD4 ⁺ NS (%)	0.2 (0.1 - 1.4)	49
IL-2 ⁺ CD4 ⁺ (%)	24 (0.8 - 67)	63
IL-2 ⁺ CD8 ⁺ NS (%)	5.8 (0 - 30)	459
IL-2 ⁺ CD8 ⁺ (%)	3.7 (0.3 - 7.8)	127
CD25 ^{High} CD3dim NS (%)	1.6 (0.0 - 3.7)	644
CD25 ^{High} CD3dim (%)	12 (0.2 - 37)	82
CD25 ^{High} CD4dim NS (%)	1.9 (0 - 5)	10089
CD25 ^{High} CD4dim (%)	14 (0.3 - 37)	67
CD25 ^{High} CD8dim NS (%)	0.1 (0 - 0.2)	46
CD25 ^{High} CD8dim (%)	5.8 (0 - 26)	355

The mean stim: NS ratios were 1.6 for NFAT1⁺PBMC nuclei, 120 for IL-2⁺CD4⁺, 0.6 for IL-2⁺CD8⁺, 7.5 for CD25^{High}CD3dim, 7.4 for CD25^{High}CD4dim and 58 for CD25^{High}CD8dim. Interestingly, with the exception of NFAT1⁺PBMC nuclei⁺ and IL-2⁺CD4⁺, the expression of the different pharmacodynamics biomarkers was less than the limit of detection of the flow cytometry technique in some patients, contrary to stimulated levels that were always measurable (except for CD25^{High}CD8dim).



Pharmacological (NS) and stimulated NFAT1 in PBMC nuclei exhibited mild to moderate inter-individual variability (CV = 15%, corresponding to a 9-fold range), whereas larger values in stimulated and non-stimulated conditions for IL-2 in CD4 T cells, CD25 in stimulated CD3 and CD4 lymphocytes and in non-stimulated CD8 lymphocytes (CV% between 49 and 82%) were observed. However, much higher CV% values were found for CD25 in stimulated CD8 T cells (CV% = 355%), and in non-stimulated CD3 and CD4 T lymphocytes (CV% between 644 and 10089%) as well as for IL-2 in stimulated CD8 T cells (CV% of 127%). As a consequence, the inter-individual variability of stimulated markers was less than or equal to that of “pharmacological” levels, except for IL-2⁺CD4⁺ and CD25^{High}CD8dim.

Multivariate analysis (Table IV.2.6.1 and 2) revealed that recipient age was positively associated with the unstimulated levels of NFAT1⁺ in PBMC nuclei and that HCV etiology was correlated with CD25^{High} expression in CD8⁺ T cells after PMA/I stimulus.

PHARMACOGENETIC-PHARMACODYNAMIC RELATIONSHIPS

Statistical associations after Bonferroni correction between genetic variants and either non-stimulated or ex-vivo stimulated phenotypes are summarized in Table IV.4.2.6 and IV.4.2.7. Moreover, these tables show covariate contributions to the variability of the cyclosporine pharmacodynamic biomarkers.



Influence of the recipient genome: recipients who carried the ABCB1 1128503T wild-type allele exhibited higher unstimulated levels of IL-2 in CD8⁺ T cells, while carriers of the recipient PPIA rs8177826G mutated allele expressed decreased levels of IL-2 in stimulated CD8⁺ T and in CD25^{High} CD3⁺ T cells.

Multivariate analysis evidenced that recipient wild-type allele of ABCB1 T1128503C upregulates IL-2 expression in non-stimulated CD8⁺ T cells, whereas in stimulated conditions the mutated allele in the promoter region of cyclophilin A G8177826A downregulates IL-2 expression in CD4⁺ and CD8⁺ T cells and in CD25^{High}CD3⁺ T cells. Furthermore the mutated allele of calcineurin regulatory subunit promoter region PPP3R1 T4519508C increases the expression of CD25^{High}CD4⁺ T cells.

Curiously, together with the influence of HCV pre-transplantation status three genes emerged as relevant determinants of CsA pharmacodynamics after Bonferroni's correction: ABCB1, PPIA and PPP3R1. ABCB1 1128503T explained 74% of the variability of non-stimulated IL-2⁺CD8⁺, PPP3R1 4519508T 80% of that of stimulated CD25^{High} expression in CD4⁺ T cells and HCV 76% of the variability of stimulated CD25^{High} expression in CD8⁺ T cells. Furthermore, PPIA 8177826G accounted for 87% of the variability in IL-2⁺CD4⁺, 77% of that of IL-2⁺CD8⁺ and 83% of the variability of CD25^{High}CD3dim lymphocytes in stimulated conditions.

No relevant influence from donor genetic characteristics on CsA PK was found using our cause-effect model.



Table IV.4.2.6. Covariate associations with cyclosporine PD biomarkers in non-stimulated conditions.

PD biomarker	Recipient Associated parameter	Genetic Model	$\beta \pm SD$ (Multivariate Model)	Modulation	p value* (Multivariate Model)	Contribution to Variability (%)
NFAT1 in PBMC nuclei ⁺ NS	Age	NA	0.03 ± 0.01	↑	0.042	20
IL-2 in CD8 ⁺ NS	rs8177826 PPIA	G vs A	11 ± 2	↑	0.012	21
	rs1128503 ABCB1 wt	T vs C	17 ± 4	↑	0.0008	74
CD25 ^{High} CD4 ⁺ NS	rs2760501 JUN wt	T vs G	-3.6 ± 1.3	↓	0.028	19
	rs2069762 IL2	C vs A	-3.1 ± 0.8	↓	0.028	72
CD25 ^{High} CD8 ⁺ NS	rs6850 PPIA	G vs A	-0.17 ± 0.05	↓	0.017	77

*Values in bold are significant at p< 0.05 for multivariate models and p<0.010 after Bonferroni's correction.

Table IV.4.2.7. Covariate associations with cyclosporine PD biomarkers in stimulated conditions.

PD biomarker	Recipient Associated parameter	Genetic Model	$\beta \pm SD$ (Multivariate Model)	Modulation	p value* (Multivariate Model)	Contribution to Variability (%)
IL-2 in CD4 ⁺ stim	rs8177826 PPIA	G vs A	-3.0 ± 0.5	↓	0.0003	87
IL-2 in CD8 ⁺ stim	rs8177826 PPIA	G vs A	-2.1 ± 0.4	↓	0.002	77
CD25 ^{High} CD3 ⁺ stim	rs1045642 ABCB1wt	T vs C	4.3 ± 1.1	↑	0.011	6.0
	rs8177826 PPIA	G vs A	-2.7 ± 0.7	↓	0.001	83
	rs4519508 PPP3R1	T vs C	4.3 ± 1.0	↑	0.008	10
CD25 ^{High} CD4 ⁺ stim	rs4519508 PPP3R1	T vs C	4.0 ± 0.8	↑	0.001	80
CD25 ^{High} CD8 ⁺ stim	HCV	NA	16.1 ± 3.2	↑	0.001	76

*Values in bold are significant at p< 0.05 for multivariate models and p<0.008 after Bonferroni's correction.



DISCUSSION

The first aim of this preliminary study in LTR on cyclosporine was to assess the inter-patient variability of CsA pharmacodynamics and the influence of covariates such as determined by patient characteristics, CsA exposure or genetic polymorphisms. As in our previous study in patients on TAC, we measured the expression of proteins of the calcineurin pathway both before and after ex vivo stimulation. Although certain unstimulated PD biomarker values were not measurable in some patients, none of the residual expressions measured was completely inhibited in all patients. In particular, consistent with our previous study in LTR on TAC, IL-2 expression in Th1 cells was quite elevated, while CD25 showed low to moderate expression. The unstimulated PD biomarkers exhibited larger variability than stimulated values, which was due in part to the null values assigned to unmeasurable levels, but maybe also to the absence of the normalizing effect of the mitogenic stimulus used in the stimulated conditions.

The second aim of this study was to compare the pharmacodynamics of CsA and TAC. CsA exhibited higher PD variability for almost all of the phenotypes tested, with CsA/TAC CV% ratios between 1.2 for NFAT1 in PBMC nuclei and 34 for CD25 in CD4⁺ cells in unstimulated conditions, and between 1.5 for IL-2 in CD8⁺ and 3.8 for CD25 in CD8⁺ cells in stimulated conditions.

LTR on CsA exhibited generally higher non-stimulated biomarker values than LTR on TAC, with CsA/TAC ratios of 1.4 for NFAT1 in PBMC nuclei, 2.0 for IL-2 in CD4⁺ T cells and 1.3 for CD25 in CD3⁺. However, identical mean values were found for CD25^{High} in CD4⁺ and CD8⁺ cells, while the CsA/TAC ratio was 0.6 for IL-2 in CD8⁺, meaning that IL-2⁺CD8⁺ exhibited lower expression in patients on CsA than on TAC.



After ex-vivo stimulation, IL-2 in CD8⁺ and in CD4⁺ cells and CD25^{High} in CD8⁺ cells were more inhibited on patients on CsA, CD25^{High} expression in CD3⁺ and CD4⁺ cells was equally inhibited by CsA and TAC, while NFAT1 in PBMC nuclei was apparently less inhibited by CsA. This would suggest that inhibition of T cell activation and function by CsA would be globally more efficient than that seen for tacrolimus, although the translocation of NFAT1 to the nucleus is less inhibited. However, owing to the small number of patients and lack of group comparability, this interpretation is highly speculative and in many aspects, counterintuitive.

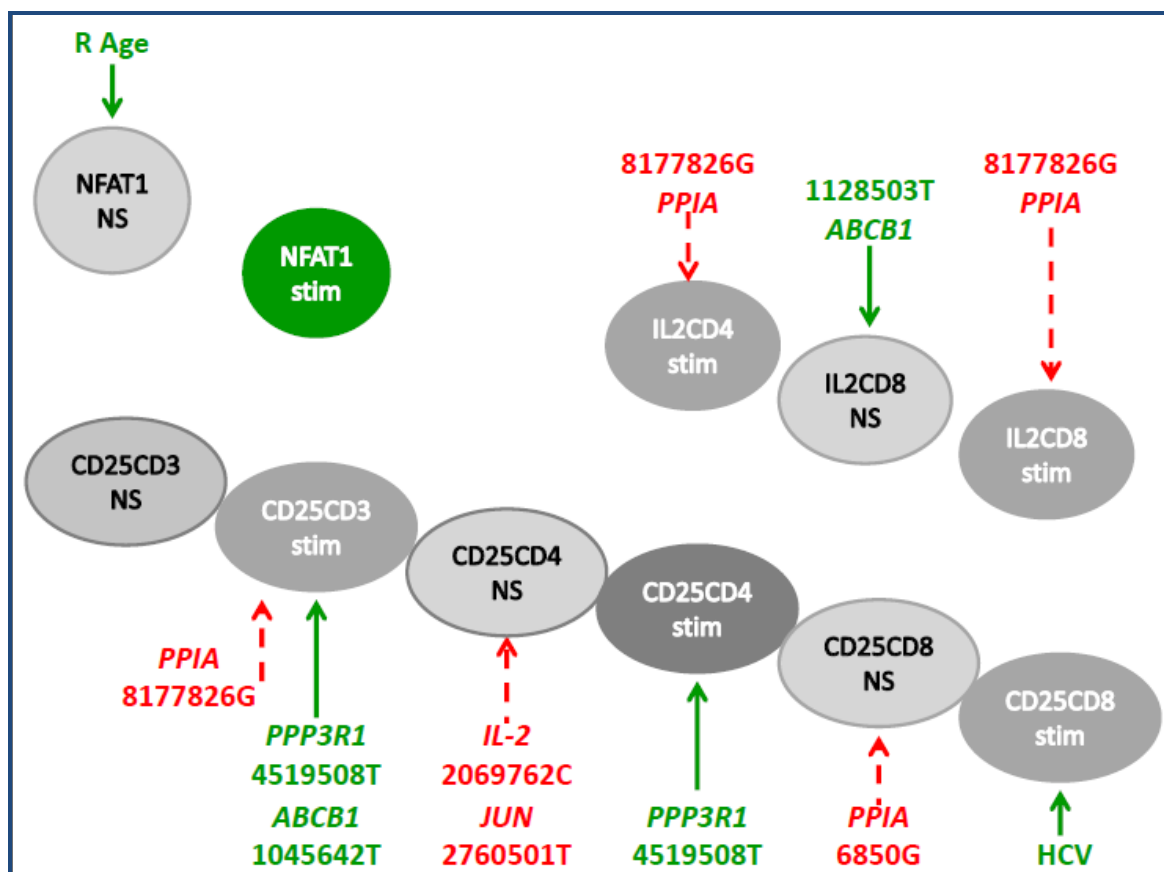

Figure IV.4.2.1. Positive and negative regulators of cyclosporine PD. Green and red dotted arrows denote up- and down-regulation of their targets respectively. Phenotypes represented by grey elipses did not show significant relationships with their partners in the pathway. Green elipses mean positive regulation.



After Bonferroni's correction, the significant associations were: the positive correlation of pre-transplantation HCV with stimulated $CD25^{High}CD8^+$, the upregulation of unstimulated $IL-2^+CD8^+$ levels in ABCB1 1128503T carriers, the upregulation of $CD25^{High}CD4^+$ stim levels by the PPP3R1 1519508T mutated allele, and the downregulation of stimulated IL-2 in $CD4^+$ and $CD8^+$ T cells and $CD25^{High}$ in $CD3^+$ T cells by the PPIA 8177826G mutated allele.

Cyclosporine and tacrolimus differ (22)(57)(98)(134)(135)(136)(137)(138) in their molecular structure and biochemical properties and even if they bind to close regions on calcineurin that have main recognition elements in common, 5 of the 25 residues of CaN involved in hydrogen bonds or hydrophobic interactions with the CNI-immunophilin complex are unique for each drug. These exclusive residues that interact with the CyPA-CsA complex are Arg-122, Tyr-315 and Trp-342 on the CaNA subunit, and Thr-362 and Lys-164 on CaNB; while those interacting with the FKBP-TAC complex are Asp-313, Met-347, and Thr-351 on CaNA, and Asn-121 and Gln-127 on CaNB. The immunophilin–drug complexes recognition patterns are quite different regarding how they establish hydrogen bonds and van der Waals interactions with such residues. Indeed, of the 9 hydrogen bonds set up between CyPA-CsA-CaN, only 4 are shared by FKBP-TAC, exhibiting the high flexibility of calcineurin for diverse protein binding. Even more, disruption in van der Waals contacts between residues of the calcineurin catalytic subunit and immunophilins leads to distinct patterns of T lymphocyte resistance to the two CNI.



If Trp-352, which is a critical residue of the CaNA subunit commonly recognized by both CNI is removed, this causes a loss of the binding energy between FKBP-TAC and CaN translated as a selective resistance to the drug, as it is the only aminoacid that forms a hydrogen bond with TAC. However, such removal is compensated for CsA because it establishes another hydrogen bond with Tyr-341. Similarly, mutagenesis on CaNB residues alters calcineurin drug-immunophilin binding affinity. The Asn-121 and Gln-127 loop forms 3 hydrogen bonds and several van der Waals interactions with TAC and FKBP, so that an insertion between these residues results in significative distortion of FKBP binding, which is not the case with CyPA-CsA which has practically no interaction with this loop.(57) Cyclosporine and tacrolimus exhibit different interactions with calcineurin and the present study shows that they also exhibit different inhibition profiles. Fukudo et al. were the first to report distinct CNI maximal effects in liver transplantation, with incomplete calcineurin inhibition by tacrolimus (134); while Zhan et al. reported different cyclosporine and tacrolimus NFAT regulated gene profiles with CsA and TAC and the lesser calcineurin inhibition by TAC in LTR.(22) Moreover, the two CNI present different cardiovascular risks, with tacrolimus showing a better profile on arterial hypertension and lipid metabolism and cyclosporine a better profile on glucose metabolism.(135) Tacrolimus also displays neurotoxicity and gastrointestinal side effects more frequently than cyclosporine.(136) Regarding CNI efficacy, tacrolimus improves patient and graft survival and prevents more episodes of acute rejection than cyclosporine after liver transplantation.(139) Chronic kidney disease may appear LTR, either due to pre-transplant condition or more often, as a CNI side effect.(137)



Cyclosporine has shown a potential superiority in preventing HCV recurrence or minimizing its severity after liver transplantation in patients infected by the virus.(138)

Taken together, all these differences between CsA and TAC can account for different pharmacodynamic features.

In summary, this pilot study highlights differences in calcineurin inhibition and pathway regulation between CsA and TAC. Almost all the PD biomarkers exhibited higher values and more variability and the influence of pharmacogenes was more pronounced with CsA; also HCV was found to have an influence on CsA PD, while it was HCC etiology for TAC. In any case, larger studies are needed to confirm these results.



IV.5. LONGITUDINAL COHORT OF LIVER TRANSPLANT PATIENTS

From the 14 patients of the waiting list enrolled in the study and who underwent transplantation, only 5 had serial monitoring over more than two visits, but two of them were rapidly switched to everolimus. Six others were enrolled immediately after transplantation and followed-up thereafter. However, two of them were also switched to everolimus early.

Due to the limited number of individuals left for this study, no result will be presented. This part of the research is being reprogrammed in order to include larger number of patients to allow proper statistical analysis. However, the management of this cohort is quite difficult because of imponderable complications after transplantation.



V.DISCUSSION

V.1. PD BIOMARKERS OF CALCINEURIN AND T CELL RESPONSIVENESS

As mentioned before, after calcineurin activation, NFAT proteins are dephosphorylated and released from their repression mechanism to translocate into the nucleus where, in the presence of the AP1 protein, they trigger the activation of target genes, including IL-2 and CD25.

Our hypothesis was that inhibition of NFAT1 nuclear translocation by CNI would be an informative biomarker of CaN/NFAT pathway signaling, in particular more specific of the immunosuppressive activity of CNI than the inhibition of calcineurin activity, the measurement of which requires inhibiting many other phosphatases. Based on previous reports by Taupin et al. (data not published) 30 minutes ex-vivo exposure to CNI and further incubation with activators is enough for signal triggering, as NFAT1 translocation occurs within minutes.

IL-2 is the principal growth factor for T lymphocytes that regulates the magnitude and duration of the T cell immune response following antigenic stimulus. Intracellular IL-2 expression by different T cell subsets was previously measured to monitor the extent of the tacrolimus pharmacological response (90), with the assumption that if this cytokine is downregulated, lymphocyte activation should be as well.

Calcineurin also controls the expression of certain T cell surface receptors, through NFAT-induced gene transcription. The expression of CD25, the high-affinity IL-2 receptor α chain, is very low in resting T cells, but it is upregulated early upon TCR activation and, together with IL-2, forms a positive auto-regulatory loop to ensure T cell activation. IL-2 and CD25 can thus be combined as tools to assess T cell responsiveness.



V.2.PRE ANALYTICAL CONSIDERATIONS

V.2.1.Stimulating Agents

All PBMC samples were stimulated ex-vivo with phorbol 12-myristate 13-acetate (PMA) and calcium ionomycin (I) and/or concanavalin A (ConA).

PMA/I and anti-CD3/anti-CD28 agents are two of the most widely applied strategies to activate T cells. Anti-CD3/CD28 works via the TCR complex, while PMA exerts its action through activation of PKC pathway, and ionomycin raises intracellular calcium level, acting on ion pump exchangers in the cell membrane. Ionomycin is a Ca^{2+} ionophore in charge of supplying external calcium stimuli, while PMA is an activator of PKC. This combination bypasses TCR and leads to polyclonal activation of several intracellular signaling pathways.(140) PMA and ionomycin are both capable to mimic TCR and coreceptor signals and together result in a vigorous stimulus for T cell cytokines synthesis, providing the best conditions for intracellular cytokine determination.(128)

The mitogen concanavalin A was employed for CD25 quantification because it induces T cell proliferation more effectively than PMA/I.(129) ConA activates phospholipase C via G α protein leading to the IP3 pathway, and also crosslinking TCR.

V.2.2.AntiCD4 Antibody Clone

One of the drawbacks of PMA/I as a stimulus is the inducing decrease of CD4 expression, due to CD4 internalization in CD4⁺ T cells. Phorbol esters enhance anti-CD4 antibody uptake, augmenting its endocytosis rate 3 to 5-fold, and doubling the proportion of anti-CD4 antibody inside the cells.(141) Following the dissociation of the CD4-p56lck complex, anti-CD4 binds to clathrin-coated pits prior to endocytosis.(142) This phenomenon is highly dependent on the anti-CD4 antibody clone: for human specimens, clones SK3, Q4120 (Becton Dickinson Protocol for Intracellular Cytokine Staining, Cytokine Detection in Antigen-Activated CD8⁺ and CD4⁺ T Cells) and Leu3a/3b (143) provide better yields over other tested clones.

Although it represents a technical challenge for intracellular cytokine determination, PMA/I remains as the gold standard for such experiments.



Brefeldin (BFA) exposure may help to prevent CD4 binding to clathrin-coated vesicles, downregulating the endocytosis seen when lymphocytes are incubated with PMA.(142) For all of our assessments of CD4 expression, we employed the SK3 anti-CD4 clone, i.e. the clone recommended by Becton Dickinson for such determinations.in order to minimize this effect.

In spite of this, we did see such a down-regulation (a shift to the left compared to the non stimulated control for CD4 subset); however the non-stimulated control for each tested subject served to draw the gate on CD4⁺ and CD8⁺ subsets, which was kept for the subsequent stimulated sample. This gating strategy, gave us the opportunity to overcome the shift due to PMA uptake. In our protocol, the SK3 clone proved to be able to resolve CD4⁺ events after PMA/I stimulation allowing discrimination of CD4⁻ from CD4⁺ events, and maintaining a sufficiently high signal-to-noise ratio to allow resolution of 0.1% of the CD4⁺ cells.

Anyway, if we extended the gate to the subset that dissociates to the left, to include both populations (CD3⁺CD8⁻) the frequency of expression of IL-2⁺CD4⁺ diminishes rather than augmenting, despite the increase of CD4 events.

As could be inferred from the figures below, and from the non-stimulated control, the difference between placing the gate on CD3⁺CD4⁺ or on CD3⁺CD8⁻ is 23% in favor of CD3⁺CD8⁻. Similar results are obtained with the stimulated samples, but if we focus on IL-2 expression in particular, we could see that if we gate on CD3⁺CD8⁻ the percentage acquired is lower. Moreover, if the inaccuracy in gate drawing is higher, the pharmacodynamics model fitting will be less.



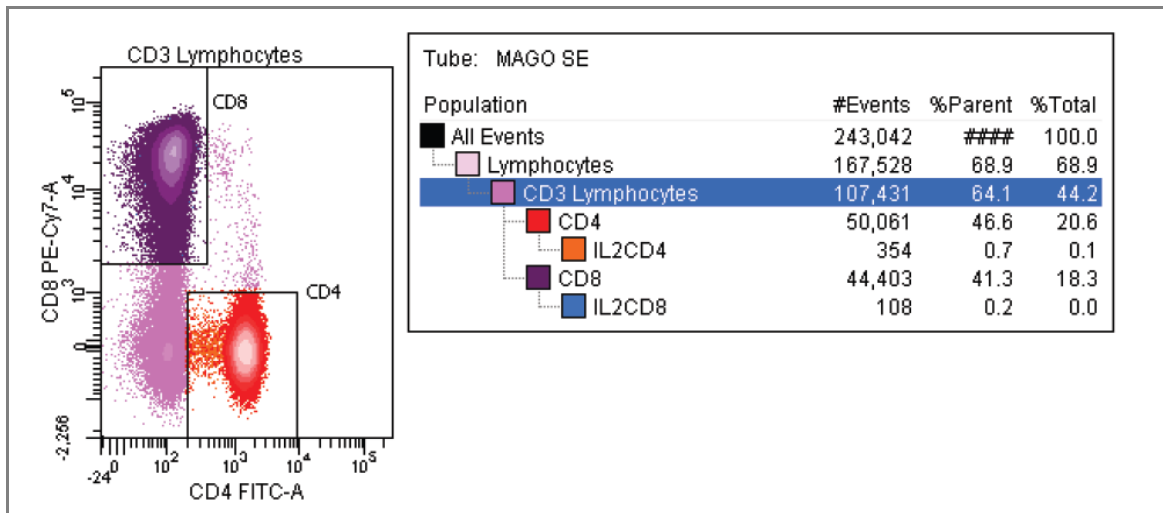

Figure V.2.1. Intracellular IL-2 expression in non-stimulated CD4⁺ T cells in healthy volunteers gating strategy by flow cytometry.

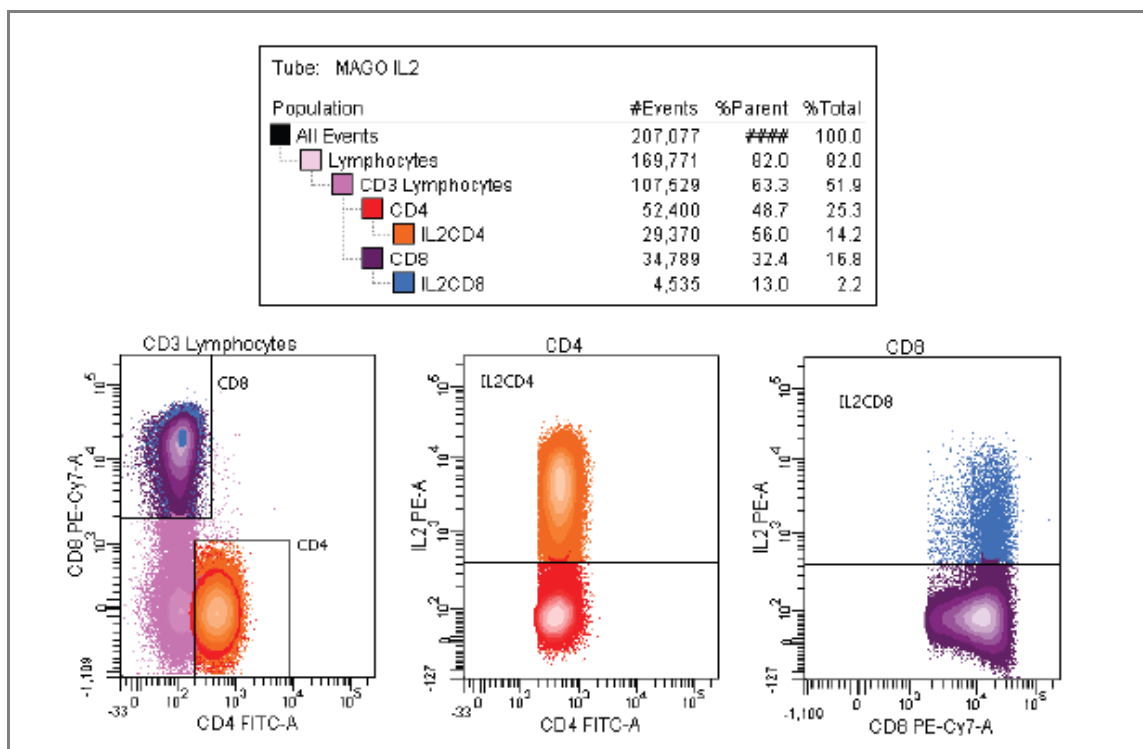

Figure V.2.2. Intracellular IL-2 expression in stimulated CD4⁺ T cells with PMA/I in healthy volunteers gating strategy by flow cytometry.



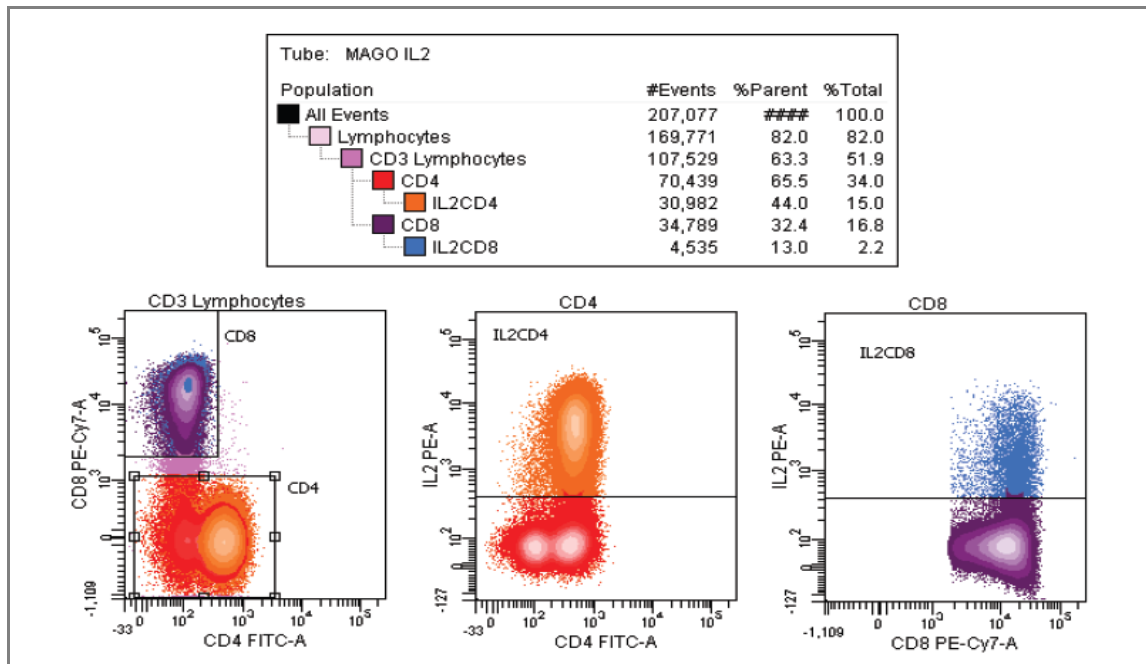

Figure V.2.3. Intracellular IL-2 expression in stimulated CD4⁺ T cells with PMA/I in healthy volunteers by flow cytometry, including in the gating strategy internalized anti-CD4.

V.3. ANALYTICAL CONSIDERATIONS

V.3.1. Flow Cytometry Performance and Standardization

Even though flow cytometry is increasingly used as a clinical diagnostic tool, there is still no consensus about the regulation of laboratory developed tests (LDT) with this technology.

Neither FDA nor EMEA have yet issued guidance documents regarding LDT and, until very recently, the existing documents issued by other bodies were principally designed for clinical chemistry methods, not for cell-based assays using fluorescence detection.

Validation of fluorescence cell-based methods is complex, due to the lack of reference methods, materials and laboratories available. Cell reference materials are not homogeneous or stable with time, while flow cytometry has a high sensitivity (below 1,000 molecules per cell) with a high degree of precision. In addition, the small volumes of precious sample specimens constitute another limitation that renders the validation process difficult.



Flow cytometry bioanalytical outputs are categorized as relative-quantitative, quasi-quantitative and/or qualitative data according to the criteria of the American Association of Pharmaceutical Scientists. Recently, the International Council for Standardization of Hematology (ICSH) and the International Clinical Cytometry Society (ICCS) published several practice guidelines concerning validation of cell based fluorescence analysis. The final remark made for flow cytometry LDT was to monitor for consistency of critical performance factors.(144) Some of our experiments were conducted before these ICSH/ICCS practice guidelines were published; however we have followed certain important, internal rules in order to standardize our protocols and obtain reproducible results, which we think are consistent with the most important ICSH/ICCS recommendations.

Lymphocytes were chosen as an internal biological control population in order to place adequately the light scatter settings of the instrument. Inclusion of the Forward Scatter-Height (FSC-H) parameter allows discrimination of doublets in a Forward Scatter-Area (FSC-A) versus FSC-H bivariate plot, contributing further to the accuracy of the results. On a daily basis, monitoring of instrument performance was done (at each cold start) after laser stabilization for 30 min. Rainbow 8-peak beads (CST, Cytometer Setup & Tracking Beads) were acquired under EuroFlow settings (under 'disabled compensation' conditions) and the Mean Fluorescence Intensity (MFI) of the brightest peak in each fluorescence channel was compared with the corresponding target MFI value. MFI values within the target MFI $\pm 15\%$ had to be reached for the instrument to pass the check. Whenever instrument performance failed, measures such as thorough cleaning, de-gassing flow cell and verification of laser delay were taken.(127) We compensated the NFAT1, IL-2 and CD25 assay fluorescence by means of the automatic fluorescence compensation tool available in DIVA software of Becton Dickinson (BD) LSRFortessa and Cantoll digital multiparameter instruments, using CompBeads.



V.3.2. Flow Cytometry gating strategy

As the stability of antigen expression of CD4⁺ T cells across individuals has been well established, we decided to use the CD4⁺ T cell subset as the stopping gate in our assays whenever possible. To our knowledge, there is no standardized method for gating intracellular cytokine staining. Currently, the decision about where to draw a gate precisely is highly subjective and gate placement is largely based on the operator's visual assessment, inevitably increasing the variability within and across institutions, a fact that is not easy to solve due to the lack of a "gold standard" or a reference material that helps to confirm accurate measurement of the true value.(145)

V.3.3. Assay Validation

The specificity of our markers was ensured by the design of our experiments, the cell subset targets, antibodies and fluorochromes chosen, as well as by our gating strategies.

Our protocol sensitivity was determined by the principle of fluorescence minus one (FMO) control that gave us LOD/LOB (limit of detection/limit of blank) values of 0.18% for IL-2⁺CD4⁺, 0.25% for IL-2⁺CD8⁺ and 0.25% for NFAT1 (data obtained from the healthy donor study).

When we submitted our first manuscript, we were asked by one of the reviewers to further validate our analytical protocols in the conditions of routine. So we collected 50 ml of blood from 5 healthy volunteers, and for each subject we analyzed the same sample in 5 replicates each day for 3 consecutive days. For this, we had to culture the cells over the 3 days. Finally, we observed that for most of the markers, replication on the second and third days was not feasible, due to abrogated expression, thus invalidating the trial. Maybe an alternative to this procedure would be to cryopreserve PBMC aliquots in order to thaw the corresponding cells each day.(146) However, we were able to demonstrate excellent intra-day analytical reproducibility in healthy donors.



As far as the analytical variability is concerned, coefficients of variation at physiological levels (I_0) were always less than 9%, while those at 5 ng/ml TAC (i.e., approximately at the IC_{50} concentration) were somewhat higher, ranging from 1.5 to 11%, with the notable exception of IL-2 in $CD8^+$ cells which apparently peaked at 62%.

Indeed, the smaller the acquired values, like in the case of IL-2⁺CD8⁺ expression at 5 ng/ml TAC (<2% and often undetectable), the larger the imprecision.

The intra-individual variability estimated in 3 different healthy volunteers ranged from 3.2 to 6.5% for I_0 and from 8.6 to 17% for IC_{50} , except for NFAT1 (IC_{50} CV% = 50%)

Table. V.3.1. Analytical and intra-individual variability of biomarker log transformed measurements.

PD Biomarker	Analytical variability		Intra-individual variability	
	I_0 CV(%)	Effect at 5 ng/ml TAC CV(%)	I_0 CV(%)	IC_{50} CV(%)
NFAT1 (MFI)	1.1	1.5	6.3	50
IL-2 ⁺ CD4 ⁺ (%)	2.2	8.6	4.7	8.6
IL-2 ⁺ CD8 ⁺ (%)	8.9	62	6.5	17
CD25 ⁺ CD3 ⁺ (%)	6.3	11	3.2	14

We set-up a repeatable technique for this study, as evidenced by its overall low to mild analytical variability. The very high CV% found for IL-2 in $CD8^+$ cells incubated with 5 ng/ml TAC is partially an artifact, due to the fact that this concentration corresponds to approximately 5 times the IC_{50} for this marker (0.98ng/ml). In all other cases, it was less than the intra-individual and inter-individual variability values. Our analytical variability was consistent with what other researchers described, although comparisons are difficult owing to different markers, cell types and experimental schemes (21)(147)(148)(149)(150)(151).



V.4. POST ANALYTICAL CONSIDERATIONS

Another issue was that I analyzed more than 20,000 images using the same strategy for all in order to minimize gating variability, a number and a workload difficult to bear for a single operator. The DIVA computer program, which I used for healthy volunteers, is not as versatile and as significantly less resolute than, FLOWJO or INFINICYT; and FLOWJO allowed me to analyze simultaneously a larger number of images than INFINICYT, which blocked after merging more than 15 patients.

V.5. NEW DISCOVERIES IN TAC PK/PD/PGX RELATIONSHIPS

This work has produced several new findings. After complete exploration of the calcineurin pathway by simultaneous PK/PD/PG approach in humans or in human cells ex-vivo, TAC pharmacodynamics is consistent from NFAT1 in PBMC nuclei down to CD25 in several T subsets, following an I/I_{max} model at each step, while IL-2 and CD25 response depend on NFAT1 nuclear translocation inhibition in PBMC nuclei, following an allosteric sigmoidal model. Particular pharmacogenes of the calcineurin pathway influence tacrolimus pharmacodynamics ex-vivo, as well as the corresponding pharmacodynamic biomarkers in LTR on either tacrolimus or cyclosporine. None of the biomarkers downstream calcineurin/NFAT1 or any other covariate apparently influenced TAC PD at any study level.

Some of these TAC and CsA pharmacodynamic biomarkers can be measured without ex-vivo stimulation, which may reflect more faithfully their actual pharmacological activity than after mitogenic stimulation. These biomarkers were not influenced by TAC or CsA dose or trough blood levels and displayed a large inter-individual variability in both NS and stim conditions.

As CNI target T cell function, CNI quantification in lymphocytes could be a better surrogate marker of the immune function than whole blood levels.(1)(91)



Intralymphocyte TAC levels are also better associated to acute rejection than whole blood levels,(1) probably because they integrate potential inter-individual variations of drug entry into the lymphocytes.(152) These findings are also in favor of TAC lymphocyte pharmacodynamics monitoring.(153) In the same line, previous studies showed that intrahepatic TAC levels displayed excellent correlation with the Banff rejection scores, whereas trough levels did not (1)(153).

During an acute inflammatory state, the recipient immune response is directed by the balance of two opposing forces, the pro-inflammatory (Th1) reaction (involving the cytokines IL-2 and IFN γ), which recruits inflammatory cells to damaged sites and the anti-inflammatory response (led by TNF α , IL-1 β and IL-6), whose role is to limit tissue injury and promote healing. Monocytes and lymphocytes participate in both immune mechanisms.(93) The resulting balance of these two cascades determines the extent of host inflammatory reaction and clinical outcomes. Although most pro-inflammatory and immunoregulatory cytokines are upregulated during ACR, they cannot distinguish between ACR and infections, limiting their clinical utility.(4)

In organ transplantation one of the purposes of anticalcineurin drugs is to reduce IL-2 production (T cell growth factor), in order to minimize inflammation and graft rejection.(84) IL-2 levels in serum or plasma are not accurate to diagnose rejection. On the contrary, significant association was reported with IL-2 expression in lymphocytes infiltrating the liver graft and acute rejection. Intracellular IL-2 expression in PBMC may thus better reflect CNI effect in graft recipients.(13)

Administration of corticosteroids modulates the inflammatory response in favor of the most potent anti-inflammatory cytokine IL-10 (Th2), decreasing circulating TNF α , IL-6, and IL-8 levels.(93) However an IL-10 polymorphism at position 1082 has been shown to be responsible for IL-10 downregulation and would thus represent a genetic risk factor of acute liver rejection(154). We did not investigate this polymorphism, as it is not involved in the calcineurin pathway. Actually, IL-10 signaling works via the activation of Janus kinase 1 and Tyrosine kinase 2.



In our research, IL-2 expression in Th1 cells of LTR on TAC was quite elevated, reaching the same values as in healthy volunteers out of the drug, pointing out the existence of an activated/inflammatory status in the patients, maybe due to the immunological conflict between the graft and the recipient despite the action of immunosuppressants. In contrast, IL-2 expression in CD8⁺ cytotoxic T lymphocytes was lower in patients than in healthy volunteers.(2)

ACR occurred in 56% of our LTR on TAC (23% with BS≤ 3, 32% with BS≤6 and 1% with BS≤9) between 1 and 124 days post-transplantation, and in 30% of the LTR on CsA (20% with BS≤ 3, and 10% with BS≤6) between 22 and 2927 days after transplantation. These surprising results might be explained by the different profiles of patients on TAC and CsA, by which the former may have higher rejection risks.

Previous studies by Canivet et al. reported that liver cirrhosis in pre-transplant patients was associated with lower T cell activation, except in HCV-positive patients in whom T cells are stimulated due to the infection.(26) Our study in transplant patients also verified this observation. Moreover, patients with unstimulated CD25^{High}CD4^{dim} levels < 1.2%, or < 3% after mitogen stimulation, further developed at least one episode of rejection. In particular, one patient whose calcineurin pathway was monitored 48h after transplantation while on basiliximab induction and free of CNI, exhibited undetectable unstimulated expression of CD25^{High}CD4⁺, while expression only reached 1.1% after stimulation; 96h after transplantation he exhibited considerable alteration of his liver enzymes, while the graft biopsy confirmed ACR with a Banff score of 4/9. Moussamba et al. presented a similar predictor in a pilot study in 25 liver transplant patients (personal communication), while other studies reported that lower levels of Treg cells in liver transplant patients were associated with acute rejection.(154)(155)(156)

NFAT1 regulates the expression of the pro-inflammatory cytokines required in cell transformation.(157) A link between inflammation and cancer has been identified and the critical elements in common are transcription factors such as NFκB, which controls the inflammatory response through soluble mediators (cytokines, chemokines) and cellular components (macrophages), promoting tumorigenesis. NFκB collaborates in the proliferation and survival of malignant cells, enhancing angiogenesis and metastasis,



destabilizing adaptive immunity, and altering the responses to hormones and chemotherapeutic agents.(158)

In our study, 13% of the patients were mono-infected or co-infected by the hepatitis C virus. Intrahepatic IFN γ and IL-2 messenger RNA levels linked to liver fibrosis and portal-tract inflammation suggest that progressive liver injury in chronic hepatitis C infection is characterized by a Th1 profile.(26) We did not confirm the observation by Canivet et al.(26) related to positive association of HCV infection with ACR in liver transplant patients. IL-2 protein expression in CD4⁺ cells was higher in our transplanted patients than in patients of the waiting list and slightly higher than in healthy volunteers. Canivet et al. did not find any relevant link between pharmacodynamic markers and hepatocellular carcinoma. In contrast, we found significant association between HCC and unstimulated CD25^{High}CD8dim levels. This is coherent given that CD8⁺ cytotoxic cells contribute to HCC development. Both CD8⁺ and NKT cells induce liver damage, and NF κ B participates in the transition towards HCC.

Prior studies have discussed the influence of donor and recipient age on graft survival,(132) owing to functional changes in white blood cells which may be partially responsible for cellular and humoral immunodeficiency in the elderly. Böhler et al. postulated that age exerts an influence on specific T cell functions and that the increase of pro-inflammatory cytokine expression with age would affect allograft survival. Furthermore, the authors suggested that the positive correlation between CD25^{High} activated T cells and age they found in transplant patients may upregulate T cell proliferation in response to IL-2.(132)

Our results in LTR on TAC also show a positive correlation between recipient age and unstimulated CD25^{High} expression in CD3⁺ and CD4⁺ T cells. 71% of our patients were on mycophenolate drugs and TAC, so that it is logical to observe lower CD25 values than in patients on the waiting list and without immunosuppressors. Similar to Böhler et al. (132) and Lemaitre et al.(153), we did not find any significant relationship between tacrolimus trough levels and biomarkers of T cell function or activation.

The fact that our pre-transplant patients exhibited for practically all the markers studied lower levels than healthy volunteers is in line with Canivet et al.'s observations



that liver diseases reduce T cell activation.(26) This might partly explain the lower requirements of immunosuppression in LTR compared to recipients of other allografts.

Different variants within the same promoter region of cyclophilin A can upregulate or downregulate T cell activation, however without or with T cell stimulation, respectively. SNPs within the promoter regions of the catalytic and regulatory calcineurin subunits are capable to influence T cell transcriptional activity, activation, and function. We observed that PPIA8177826G decreased the potency (IC_{50}) of TAC on NFAT1 in PBMC nuclei in healthy volunteers, while in patients of the waiting list for LT it downregulated the basal level (I_0) of CD4 T cell function and activation. Similarly, the wild-type rs11594656 and rs3528528 variants of IL2RA downregulate basal (I_0) T cell function while their mutated variants downregulate T cell activation in healthy volunteers, and upregulate TAC potency (IC_{50}) on these biomarkers in WLP (Table V.5.1).

All these relationships further contribute to reveal the complexity of calcineurin pathway regulation and TAC pharmacodynamics.

Table V.5.1. Pharmacogene influence on TAC PD parameters in healthy volunteers (HV), patients of the waiting list of liver transplantation (WLP) and liver transplant recipients (LTR).

	NS	I_0	IC_{50}	I_{max}
HV	ND	IL2RA Haplo ATC wt ↓ IL2CD4 IL2RA HaploAAT ↓ CD25CD3	PPIA 817G ↓ NFAT1	PPP3CA _{10/10} ↑ IL2CD4
WLP	PPP3CA149C ↑ NFAT1	PPIA817G ↓ CD25CD4	NS	IL2RA115T ↑ CD25CD4
LTR	NS	NA	NA	NS

ND, not available; NS, not significant; NA not applicable. For LTR I_{max} column corresponds to TAC through levels concentration.



V.6. FURTHER SOURCES OF VARIABILITY OF CNI

As previously described in the first part of this manuscript, there are further sources of response variability to CNI, such as thresholds of activation of T lymphocytes, relying on TCR, CaM, calcineurin/NFAT, IL-2, NFAT expression of different isoforms, as well as physiological levels of T lymphocytes and Tregs. There are different responses in this network due to high interindividual variability at all levels of this complex web. CaN activity is too high in the network to represent the whole range of variability and probably NFAT1 translocation as well. On the contrary, IL-2 and CD25 are the biomarkers that integrate most sources of variance. Furthermore, as they are responsible for T cell function and activation, respectively, they are closer to the immune response and their determination might better predict clinical outcomes.



VI. CONCLUSIONS and PERSPECTIVES

This is the first time that the calcineurin pathway has been completely explored in a simultaneous PK/PD/PG approach in humans or in human cells ex-vivo. NFAT1, IL-2 and CD25 inhibition followed I/I_{max} models, TAC pharmacodynamics was consistent from NFAT1 translocation in PBMC nuclei down to CD25 expression in several T subsets and IL-2 and CD25 responses to NAFT1 inhibition fitted and allosteric sigmoidal model. Pharmacophysiological levels of CNI PD biomarkers in liver transplant recipients could be measured without prior ex vivo stimulation. We also reported pharmacogenetic influences on the TAC PD parameters ex vivo and PD biomarkers in patients on TAC or CsA, as well as pharmacodynamic interactions within the pathway.

The most relevant polymorphisms that emerged from our study were in: PPIA, PPP3CA and IL2RA in HV and WLP; ABCB1, PPIA and IL2RA in LTR on TAC; and ABCB1, PPIA and PPP3R1 in LTR on CsA. However, after Bonferroni's correction none of them had influence on PD biomarkers in LTR on tacrolimus, suggesting that either our study was underpowered to discover such associations or that the genetic influences are hindered by the inhibitory effect of tacrolimus, leaving other sources of variability only.

The PD biomarkers most resistant to complete inhibition ex-vivo were NFAT1 and CD25 in healthy volunteers, and NFAT1 and IL-2⁺CD8⁺ in patients on the waiting list. In LTR on TAC, in the same stimulated conditions, none of the biomarkers were fully inhibited (while in unstimulated conditions, IL-2⁺CD4⁺ and CD25^{High}CD8⁺ were almost undetectable).



CsA showed more variability in the resulting biomarkers compared to TAC, and more efficient inhibition of T cell activation, despite less NFAT1 inhibition. Furthermore, the unstimulated, “pharmaco-physiological” values integrated more variability than stimulated values, both for CsA and TAC. The auto-regulatory loop between IL-2 and CD25 was evident here and exerted a strong influence on TAC PD.

None of the biomarkers was influenced by CNI dose or trough levels, while recipient’s age, HCC and HCV pre-transplantation had a significant influence on TAC pharmacodynamics.

Finally, the best PD biomarker candidates may be those which integrate the largest part of inter-individual variability, i.e. IL-2 and CD25 in CD8⁺ T cells. In addition, a few case reports suggest that the diminution of Tregs may predict ACR in LTR (156)(155), while NFAT1 inhibition may predict infection episodes (the latter being consistent with previous reports).

One aim of this study was to assess TAC pharmacodynamics in serial monitoring of patients included while on the waiting list and followed-up over the first year after transplantation. However, due to the difficulties with the management of early transplant recipients (e.g., corticosteroid administration pre-transplantation or switch to everolimus post-transplantation), we were unable to attain a sufficient number of patients to analyse the results and draw conclusions. Despite only 4 such patients followed-up at the present time, our intention persists. The objective is to evaluate the intra-individual variability over the follow-up period, and above all the influence of the PD biomarkers on clinical outcomes.



Also, we aimed at studying the transcription levels of IL-2 and IL2R α , as a comparison with the response of the proteins involved in the activated CaN/NFAT pathway. In this aim we have collected blood samples and extracted mRNA during programmed pharmacodynamic monitoring, taking all pre-analytic and analytical precautions so as to be able to compare mRNA expression with protein expression by flow cytometry. cDNA conversion and gene expression measurement are programmed for the next step.

Finally, to validate our findings prospectively and in a larger number of patients we are planning a multicentric trial, including two liver transplant centers outside Uruguay and maybe including the renal transplant cohort of the Uruguayan National Center, as a comparative group. The biomarkers monitored will probably be NFAT1 in PBMC nuclei, IL-2 expression in CD8⁺ T cells, IL-17⁺ in CD4⁺ and Tregs.



REFERENCES

1. Capron A, Lerut J, Latinne D, Rahier J, Haufroid V, Wallemacq P. Correlation of tacrolimus levels in peripheral blood mononuclear cells with histological staging of rejection after liver transplantation: preliminary results of a prospective study. *Transpl Int Off J Eur Soc Organ Transplant*. 2012 Jan;25(1):41–7.
2. Noceti OM, Woillard J-B, Boumediene A, Esperón P, Taupin J-L, Gerona S, et al. Tacrolimus Pharmacodynamics and Pharmacogenetics along the Calcineurin Pathway in Human Lymphocytes. *Clin Chem*. 2014 Oct;60(10):1336–45.
3. Rodrigo E, López-Hoyos M, Corral M, Fábrega E, Fernández-Fresnedo G, San Segundo D, et al. ImmuKnow as a diagnostic tool for predicting infection and acute rejection in adult liver transplant recipients: a systematic review and meta-analysis. *Liver Transplant Off Publ Am Assoc Study Liver Dis Int Liver Transplant Soc*. 2012 Oct;18(10):1245–53.
4. Germani G, Rodriguez-Castro K, Russo FP, Senzolo M, Zanetto A, Ferrarese A, et al. Markers of acute rejection and graft acceptance in liver transplantation. *World J Gastroenterol WJG*. 2015 Jan 28;21(4):1061–8.
5. Brunet M. Cytokines as predictive biomarkers of alloreactivity. *Clin Chim Acta Int J Clin Chem*. 2012 Sep 8;413(17-18):1354–8.
6. Chen Y, Tai Q, Hong S, Kong Y, Shang Y, Liang W, et al. Pretransplantation soluble CD30 level as a predictor of acute rejection in kidney transplantation: a meta-analysis. *Transplantation*. 2012 Nov 15;94(9):911–8.
7. Ge Y-Z, Yu P, Jia R-P, Wu R, Ding A-X, Li L-P, et al. Association between transforming growth factor beta-1 +869T/C polymorphism and acute rejection of solid organ allograft: A meta-analysis and systematic review. *Transpl Immunol*. 2014 Mar;30(2-3):76–83.
8. Wu W, Liu Y, Li S, Hu L, Sun X, Cai L, et al. Association between IL-4 polymorphism and acute rejection of solid organ allograft: a meta-analysis. *Gene*. 2013 Jan 15;513(1):14–21.
9. Massoud O, Heimbach J, Viker K, Krishnan A, Poterucha J, Sanchez W, et al. Noninvasive diagnosis of acute cellular rejection in liver transplant recipients: a proteomic signature validated by enzyme-linked immunosorbent assay. *Liver Transplant Off Publ Am Assoc Study Liver Dis Int Liver Transplant Soc*. 2011 Jun;17(6):723–32.



10. O'Leary JG, Michelle Shiller S, Bellamy C, Nalesnik MA, Kaneku H, Jennings LW, et al. Acute liver allograft antibody-mediated rejection: an inter-institutional study of significant histopathological features. *Liver Transplant Off Publ Am Assoc Study Liver Dis Int Liver Transplant Soc.* 2014 Oct;20(10):1244–55.
11. Yano I. Pharmacodynamic monitoring of calcineurin phosphatase activity in transplant patients treated with calcineurin inhibitors. *Drug Metab Pharmacokinet.* 2008;23(3):150–7.
12. Millán O, Benitez C, Guillén D, López A, Rimola A, Sánchez-Fueyo A, et al. Biomarkers of immunoregulatory status in stable liver transplant recipients undergoing weaning of immunosuppressive therapy. *Clin Immunol Orlando Fla.* 2010 Dec;137(3):337–46.
13. Boleslawski E, Conti F, Sanquer S, Podevin P, Chouzenoux S, Batteux F, et al. Defective inhibition of peripheral CD8+ T cell IL-2 production by anti-calcineurin drugs during acute liver allograft rejection. *Transplantation.* 2004 Jun 27;77(12):1815–20.
14. Yu X, Liu Z, Wang Y, Wang H, Zhang M, Sun Y, et al. Characteristics of V δ 1(+) and V δ 2(+) $\gamma\delta$ T cell subsets in acute liver allograft rejection. *Transpl Immunol.* 2013 Dec;29(1-4):118–22.
15. Lunz J, Ruppert KM, Cajaiba MM, Isse K, Bentlejewski CA, Minervini M, et al. Re-examination of the lymphocytotoxic crossmatch in liver transplantation: can C4d stains help in monitoring? *Am J Transplant Off J Am Soc Transplant Am Soc Transpl Surg.* 2012 Jan;12(1):171–82.
16. Hübscher SG. Antibody-mediated rejection in the liver allograft. *Curr Opin Organ Transplant.* 2012 Jun;17(3):280–6.
17. Steinebrunner N, Sandig C, Sommerer C, Hinz U, Giese T, Stremmel W, et al. Pharmacodynamic monitoring of nuclear factor of activated T cell-regulated gene expression in liver allograft recipients on immunosuppressive therapy with calcineurin inhibitors in the course of time and correlation with acute rejection episodes--a prospective study. *Ann Transplant Q Pol Transplant Soc.* 2014;19:32–40.
18. Joshi D, Salehi S, Brereton H, Arno M, Quaglia A, Heaton N, et al. Distinct microRNA profiles are associated with the severity of hepatitis C virus recurrence and acute cellular rejection after liver transplantation. *Liver Transplant Off Publ Am Assoc Study Liver Dis Int Liver Transplant Soc.* 2013 Apr;19(4):383–94.



19. Wei L, Gong X, Martinez OM, Krams SM. Differential expression and functions of microRNAs in liver transplantation and potential use as non-invasive biomarkers. *Transpl Immunol*. 2013 Dec;29(1-4):123–9.
20. Oellerich M, Schütz E, Kanzow P, Schmitz J, Beck J, Kollmar O, et al. Use of graft-derived cell-free DNA as an organ integrity biomarker to reexamine effective tacrolimus trough concentrations after liver transplantation. *Ther Drug Monit*. 2014 Apr;36(2):136–40.
21. Giese T, Zeier M, Schemmer P, Uhl W, Schoels M, Dengler T, et al. Monitoring of NFAT-regulated gene expression in the peripheral blood of allograft recipients: a novel perspective toward individually optimized drug doses of cyclosporine A. *Transplantation*. 2004 Feb 15;77(3):339–44.
22. Zahn A, Schott N, Hinz U, Stremmel W, Schmidt J, Ganten T, et al. Immunomonitoring of nuclear factor of activated T cells-regulated gene expression: the first clinical trial in liver allograft recipients. *Liver Transplant Off Publ Am Assoc Study Liver Dis Int Liver Transplant Soc*. 2011 Apr;17(4):466–73.
23. Vafadari R, Bouamar R, Hesselink DA, Kraaijeveld R, van Schaik RHN, Weimar W, et al. Genetic polymorphisms in ABCB1 influence the pharmacodynamics of tacrolimus. *Ther Drug Monit*. 2013 Aug;35(4):459–65.
24. Dessilly G, Elens L, Panin N, Capron A, Decottignies A, Demoulin J-B, et al. ABCB1 1199G>A genetic polymorphism (Rs2229109) influences the intracellular accumulation of tacrolimus in HEK293 and K562 recombinant cell lines. *PloS One*. 2014;9(3):e91555.
25. Sigdel TK, Salomonis N, Nicora CD, Ryu S, He J, Dinh V, et al. The identification of novel potential injury mechanisms and candidate biomarkers in renal allograft rejection by quantitative proteomics. *Mol Cell Proteomics MCP*. 2014 Feb;13(2):621–31.
26. Canivet C, Böhrer T, Galvani S, Péron J-M, Muscari F, Alric L, et al. In vitro mitogen-stimulated T-cell from hepatitis C virus-positive liver transplantation candidates, increases T-cell activation markers and T-cell proliferation. *Transpl Immunol*. 2008 May;19(2):112–9.
27. Beals CR, Clipstone NA, Ho SN, Crabtree GR. Nuclear localization of NF-ATc by a calcineurin-dependent, cyclosporin-sensitive intramolecular interaction. *Genes Dev*. 1997 Apr 1;11(7):824–34.



28. Baine I, Abe BT, Macian F. Regulation of T-cell tolerance by calcium/NFAT signaling. *Immunol Rev.* 2009 Sep;231(1):225–40.
29. Sieber M, Baumgrass R. Novel inhibitors of the calcineurin/NFATc hub - alternatives to CsA and FK506? *Cell Commun Signal CCS.* 2009;7:25.
30. Müller MR, Rao A. NFAT, immunity and cancer: a transcription factor comes of age. *Nat Rev Immunol.* 2010 Sep;10(9):645–56.
31. Macian F. NFAT proteins: key regulators of T-cell development and function. *Nat Rev Immunol.* 2005 Jun;5(6):472–84.
32. Liu JO. Calmodulin-dependent phosphatase, kinases, and transcriptional corepressors involved in T-cell activation. *Immunol Rev.* 2009 Mar;228(1):184–98.
33. Oh-hora M. Calcium signaling in the development and function of T-lineage cells. *Immunol Rev.* 2009 Sep;231(1):210–24.
34. Feske S. Calcium : A Matter of Life or Death: A Matter of Life or Death - Google Libros [Internet]. [cited 2014 Aug 24]. Available from: [http://books.google.com.uy/books?id=gb5lgjQlvucC&pg=PA365&lpg=PA365&dq=ISSN:+0167-7306/DOI:+10.1016/S0167-7306\(06\)41014-0&source=bl&ots=AyzwBf9I1U&sig=Uw_3G54cvMgLR1luAv6k5-ilj7g&hl=es&sa=X&ei=_Tn6U43rLuih8AHptYHABQ&ved=OCB0Q6AEwAA#v=onepage&q=ISSN%3A%200167-7306%2FDOI%3A%2010.1016%2FS0167-7306\(06\)41014-0&f=false](http://books.google.com.uy/books?id=gb5lgjQlvucC&pg=PA365&lpg=PA365&dq=ISSN:+0167-7306/DOI:+10.1016/S0167-7306(06)41014-0&source=bl&ots=AyzwBf9I1U&sig=Uw_3G54cvMgLR1luAv6k5-ilj7g&hl=es&sa=X&ei=_Tn6U43rLuih8AHptYHABQ&ved=OCB0Q6AEwAA#v=onepage&q=ISSN%3A%200167-7306%2FDOI%3A%2010.1016%2FS0167-7306(06)41014-0&f=false)
35. Borde M, Barrington RA, Heissmeyer V, Carroll MC, Rao A. Transcriptional basis of lymphocyte tolerance. *Immunol Rev.* 2006 Apr;210:105–19.
36. Fathman CG, Lineberry NB. Molecular mechanisms of CD4+ T-cell anergy. *Nat Rev Immunol.* 2007 Aug;7(8):599–609.
37. Li H, Rao A, Hogan PG. Interaction of calcineurin with substrates and targeting proteins. *Trends Cell Biol.* 2011 Feb;21(2):91–103.
38. Mehta S, Aye-Han N-N, Ganesan A, Oldach L, Gorshkov K, Zhang J. Calmodulin-controlled spatial decoding of oscillatory Ca²⁺ signals by calcineurin. *eLife.* 2014;3:e03765.
39. Parekh AB. Decoding cytosolic Ca²⁺ oscillations. *Trends Biochem Sci.* 2011 Feb;36(2):78–87.



40. Srikanth S, Gwack Y. *Orai1-NFAT signalling pathway triggered by T cell receptor stimulation. Mol Cells. 2013 Mar;35(3):182–94.*
41. Feske S. *Calcium signalling in lymphocyte activation and disease. Nat Rev Immunol. 2007 Sep;7(9):690–702.*
42. Feske S, Skolnik EY, Prakriya M. *Ion channels and transporters in lymphocyte function and immunity. Nat Rev Immunol. 2012 Jul;12(7):532–47.*
43. Rhoads AR, Friedberg F. *Sequence motifs for calmodulin recognition. FASEB J Off Publ Fed Am Soc Exp Biol. 1997 Apr;11(5):331–40.*
44. Kar P, Nelson C, Parekh AB. *Selective activation of the transcription factor NFAT1 by calcium microdomains near Ca²⁺ release-activated Ca²⁺ (CRAC) channels. J Biol Chem. 2011 Apr 29;286(17):14795–803.*
45. He B, Wang K, Liu Y, Xue B, Uversky VN, Dunker AK. *Predicting intrinsic disorder in proteins: an overview. Cell Res. 2009 Aug;19(8):929–49.*
46. Cardenas ME, Hemenway C, Muir RS, Ye R, Fiorentino D, Heitman J. *Immunophilins interact with calcineurin in the absence of exogenous immunosuppressive ligands. EMBO J. 1994 Dec 15;13(24):5944–57.*
47. Ke H, Huai Q. *Structures of calcineurin and its complexes with immunophilins-immunosuppressants. Biochem Biophys Res Commun. 2003 Nov 28;311(4):1095–102.*
48. Im S-H, Rao A. *Activation and deactivation of gene expression by Ca²⁺/calcineurin-NFAT-mediated signaling. Mol Cells. 2004 Aug 31;18(1):1–9.*
49. Grigoriu S, Bond R, Cossio P, Chen JA, Ly N, Hummer G, et al. *The molecular mechanism of substrate engagement and immunosuppressant inhibition of calcineurin. PLoS Biol. 2013;11(2):e1001492.*
50. Wang P, Heitman J. *The cyclophilins. Genome Biol. 2005;6(7):226.*
51. Kang CB, Hong Y, Dhe-Paganon S, Yoon HS. *FKBP family proteins: immunophilins with versatile biological functions. Neurosignals. 2008;16(4):318–25.*
52. MacMillan D. *FK506 binding proteins: cellular regulators of intracellular Ca²⁺ signalling. Eur J Pharmacol. 2013 Jan 30;700(1-3):181–93.*
53. Göthel SF, Marahiel MA. *Peptidyl-prolyl cis-trans isomerases, a superfamily of ubiquitous folding catalysts. Cell Mol Life Sci CMLS. 1999 Mar;55(3):423–36.*



54. Hamilton GS, Steiner JP. *Immunophilins: beyond immunosuppression. J Med Chem.* 1998 Dec 17;41(26):5119–43.
55. Daum S, Schumann M, Mathea S, Aumüller T, Balsley MA, Constant SL, et al. *Isoform-specific inhibition of cyclophilins. Biochemistry (Mosc).* 2009 Jul 7;48(26):6268–77.
56. Nigro P, Pompilio G, Capogrossi MC. *Cyclophilin A: a key player for human disease. Cell Death Dis.* 2013;4:e888.
57. Huai Q, Kim H-Y, Liu Y, Zhao Y, Mondragon A, Liu JO, et al. *Crystal structure of calcineurin-cyclophilin-cyclosporin shows common but distinct recognition of immunophilin-drug complexes. Proc Natl Acad Sci U S A.* 2002 Sep 17;99(19):12037–42.
58. Hogan PG, Chen L, Nardone J, Rao A. *Transcriptional regulation by calcium, calcineurin, and NFAT. Genes Dev.* 2003 Sep 15;17(18):2205–32.
59. Macián F, López-Rodríguez C, Rao A. *Partners in transcription: NFAT and AP-1. Oncogene.* 2001 Apr 30;20(19):2476–89.
60. Okamura H, Aramburu J, García-Rodríguez C, Viola JP, Raghavan A, Tahiliani M, et al. *Concerted dephosphorylation of the transcription factor NFAT1 induces a conformational switch that regulates transcriptional activity. Mol Cell.* 2000 Sep;6(3):539–50.
61. Srinivasan M, Frauwirth KA. *Reciprocal NFAT1 and NFAT2 nuclear localization in CD8+ anergic T cells is regulated by suboptimal calcium signaling. J Immunol Baltim Md 1950.* 2007 Sep 15;179(6):3734–41.
62. Holmberg CI, Tran SEF, Eriksson JE, Sistonen L. *Multisite phosphorylation provides sophisticated regulation of transcription factors. Trends Biochem Sci.* 2002 Dec;27(12):619–27.
63. Kiani A, Rao A, Aramburu J. *Manipulating immune responses with immunosuppressive agents that target NFAT. Immunity.* 2000 Apr;12(4):359–72.
64. Marangoni F, Murooka TT, Manzo T, Kim EY, Carrizosa E, Elpek NM, et al. *The transcription factor NFAT exhibits signal memory during serial T cell interactions with antigen-presenting cells. Immunity.* 2013 Feb 21;38(2):237–49.



65. Sharma S, Findlay GM, Bandukwala HS, Oberdoerffer S, Baust B, Li Z, et al. Dephosphorylation of the nuclear factor of activated T cells (NFAT) transcription factor is regulated by an RNA-protein scaffold complex. *Proc Natl Acad Sci U S A*. 2011 Jul 12;108(28):11381–6.
66. Serfling E, Chuvpilo S, Liu J, Höfer T, Palmetshofer A. NFATc1 autoregulation: a crucial step for cell-fate determination. *Trends Immunol*. 2006 Oct;27(10):461–9.
67. König A, Fernandez-Zapico ME, Ellenrieder V. Primers on molecular pathways--the NFAT transcription pathway in pancreatic cancer. *Pancreatol Off J Int Assoc Pancreatol IAP AI*. 2010;10(4):416–22.
68. Serfling E, Avots A, Klein-Hessling S, Rudolf R, Vaeth M, Berberich-Siebelt F. NFATc1/αA: The other Face of NFAT Factors in Lymphocytes. *Cell Commun Signal CCS*. 2012;10(1):16.
69. Kaminuma O. Selective inhibitors of nuclear factor of activated T cells: potential therapeutic drugs for the treatment of immunological and inflammatory diseases. *Inflamm Allergy Drug Targets*. 2008 Mar;7(1):35–40.
70. Liu JO. The yins of T cell activation. *Sci STKE Signal Transduct Knowl Environ*. 2005 Jan 4;2005(265):re1.
71. Camargo JF, Quinones MP, Mummidi S, Srinivas S, Gaitan AA, Begum K, et al. CCR5 expression levels influence NFAT translocation, IL-2 production, and subsequent signaling events during T lymphocyte activation. *J Immunol Baltim Md 1950*. 2009 Jan 1;182(1):171–82.
72. Rudolf R, Busch R, Patra AK, Muhammad K, Avots A, Andrau J-C, et al. Architecture and expression of the *nfatc1* gene in lymphocytes. *Front Immunol*. 2014;5:21.
73. Fric J, Zelante T, Wong AYW, Mertes A, Yu H-B, Ricciardi-Castagnoli P. NFAT control of innate immunity. *Blood*. 2012 Aug 16;120(7):1380–9.
74. Daniel C, Gerlach K, Väh M, Neurath MF, Weigmann B. Nuclear factor of activated T cells - a transcription factor family as critical regulator in lung and colon cancer. *Int J Cancer J Int Cancer*. 2014 Apr 15;134(8):1767–75.
75. Buchholz M, Ellenrieder V. An emerging role for Ca²⁺/calcineurin/NFAT signaling in cancerogenesis. *Cell Cycle Georget Tex*. 2007 Jan 1;6(1):16–9.
76. Shin S-Y, Yang HW, Kim J-R, Heo WD, Cho K-H. A hidden incoherent switch regulates RCAN1 in the calcineurin-NFAT signaling network. *J Cell Sci*. 2011 Jan 1;124(Pt 1):82–90.



77. Han KA, Kang HS, Lee JW, Yoo L, Im E, Hong A, et al. Histone Deacetylase 3 Promotes RCAN1 Stability and Nuclear Translocation. *PloS One*. 2014;9(8):e105416.
78. Szíjgyártó Z, Szucs K, Kovács I, Zákány R, Sipka S, Gergely P. The role of protein kinase C isoenzymes in the regulation of calcineurin activity in human peripheral blood mononuclear cells. *Int J Mol Med*. 2007 Sep;20(3):359–64.
79. Pan F, Sun L, Kardan DB, Whartenby KA, Pardoll DM, Liu JO. Feedback inhibition of calcineurin and Ras by a dual inhibitory protein Carabin. *Nature*. 2007 Jan 25;445(7126):433–6.
80. Li H, Pink MD, Murphy JG, Stein A, Dell'Acqua ML, Hogan PG. Balanced interactions of calcineurin with AKAP79 regulate Ca²⁺-calcineurin-NFAT signaling. *Nat Struct Mol Biol*. 2012 Mar;19(3):337–45.
81. Savignac M, Mellström B, Naranjo JR. Calcium-dependent transcription of cytokine genes in T lymphocytes. *Pflüg Arch Eur J Physiol*. 2007 Jul;454(4):523–33.
82. Van Rossum HH, de Fijter JW, van Pelt J. Pharmacodynamic monitoring of calcineurin inhibition therapy: principles, performance, and perspectives. *Ther Drug Monit*. 2010 Feb;32(1):3–10.
83. Hermann-Kleiter N, Baier G. NFAT pulls the strings during CD4⁺ T helper cell effector functions. *Blood*. 2010 Apr 15;115(15):2989–97.
84. Härtel C, Schumacher N, Fricke L, Ebel B, Kirchner H, Müller-Steinhardt M. Sensitivity of whole-blood T lymphocytes in individual patients to tacrolimus (FK 506): impact of interleukin-2 mRNA expression as surrogate measure of immunosuppressive effect. *Clin Chem*. 2004 Jan;50(1):141–51.
85. Boyman O, Sprent J. The role of interleukin-2 during homeostasis and activation of the immune system. *Nat Rev Immunol*. 2012 Mar;12(3):180–90.
86. Hughes-Fulford M, Sugano E, Schopper T, Li C-F, Boonyaratankornkit JB, Cogoli A. Early immune response and regulation of IL-2 receptor subunits. *Cell Signal*. 2005 Sep;17(9):1111–24.
87. Hench VK, Su L. Regulation of IL-2 gene expression by Siva and FOXP3 in human T cells. *BMC Immunol*. 2011;12:54.
88. Imbert V, Rezzonico R, Reichenbach P, Nabholz M. Induction of interleukin-2 receptor alpha (IL-2Ralpha) expression by interleukin-2: important role of the interleukin-2 receptor beta chain region between the two Stat5 docking sites. *Eur Cytokine Netw*. 2002 Sep;13(3):331–9.



89. Ikemizu S, Chirifu M, Davis SJ. IL-2 and IL-15 signaling complexes: different but the same. *Nat Immunol*. 2012 Dec;13(12):1141–2.
90. Kim HP, Kelly J, Leonard WJ. The basis for IL-2-induced IL-2 receptor alpha chain gene regulation: importance of two widely separated IL-2 response elements. *Immunity*. 2001 Jul;15(1):159–72.
91. Li R, Sun Z, Dong J, Yin H, Guo W, Fu Z, et al. A quantitative assessment model of T-cell immune function for predicting risks of infection and rejection during the early stage after liver transplantation. *Clin Transplant*. 2013 Oct;27(5):666–72.
92. Marquet P. Counterpoint: Is pharmacokinetic or pharmacodynamic monitoring of calcineurin inhibition therapy necessary? *Clin Chem*. 2010 May;56(5):736–9.
93. Jaber BL, Pereira BJB, Bonventre JV, Balakrishnan VS. Polymorphism of host response genes: implications in the pathogenesis and treatment of acute renal failure. *Kidney Int*. 2005 Jan;67(1):14–33.
94. Staatz CE, Goodman LK, Tett SE. Effect of CYP3A and ABCB1 single nucleotide polymorphisms on the pharmacokinetics and pharmacodynamics of calcineurin inhibitors: Part I. *Clin Pharmacokinet*. 2010 Mar;49(3):141–75.
95. Fung KL, Gottesman MM. A synonymous polymorphism in a common MDR1 (ABCB1) haplotype shapes protein function. *Biochim Biophys Acta*. 2009 May;1794(5):860–71.
96. Komar AA. Silent SNPs: impact on gene function and phenotype. - PubMed - NCBI [Internet]. [cited 2015 Jan 29]. Available from: [http://www.ncbi.nlm.nih.gov/pubmed?term=Kimchi-Sarfaty,%20C.%20et%20al.%20A%20%E2%80%9Csilent%E2%80%9D%20polymorphism%20in%20the%20MDR1%20gene%20changessubstrate%20specificity.%20Science%20315,%20525%E2%80%9328%20\(2007\).%20\[all\]&cmd=correctspelling](http://www.ncbi.nlm.nih.gov/pubmed?term=Kimchi-Sarfaty,%20C.%20et%20al.%20A%20%E2%80%9Csilent%E2%80%9D%20polymorphism%20in%20the%20MDR1%20gene%20changessubstrate%20specificity.%20Science%20315,%20525%E2%80%9328%20(2007).%20[all]&cmd=correctspelling)
97. Crettol S, Venetz J-P, Fontana M, Aubert J-D, Pascual M, Eap CB. CYP3A7, CYP3A5, CYP3A4, and ABCB1 genetic polymorphisms, cyclosporine concentration, and dose requirement in transplant recipients. *Ther Drug Monit*. 2008 Dec;30(6):689–99.
98. Fukudo M, Yano I, Masuda S, Fukatsu S, Katsura T, Ogura Y, et al. Pharmacodynamic analysis of tacrolimus and cyclosporine in living-donor liver transplant patients. *Clin Pharmacol Ther*. 2005 Aug;78(2):168–81.
99. Donnenberg VS, Burckart GJ, Griffith BP, Jain AB, Zeevi A, Berg AD. P-glycoprotein (P-gp) is upregulated in peripheral T-cell subsets from solid organ transplant recipients. *J Clin Pharmacol*. 2001 Dec;41(12):1271–9.



100. Hauser IA, Schaeffeler E, Gauer S, Scheuermann EH, Wegner B, Gossmann J, et al. *ABCB1 genotype of the donor but not of the recipient is a major risk factor for cyclosporine-related nephrotoxicity after renal transplantation. J Am Soc Nephrol JASN. 2005 May;16(5):1501–11.*
101. Naesens M, Lerut E, de Jonge H, Van Damme B, Vanrenterghem Y, Kuypers DRJ. *Donor age and renal P-glycoprotein expression associate with chronic histological damage in renal allografts. J Am Soc Nephrol JASN. 2009 Nov;20(11):2468–80.*
102. Woillard J-B, Rerolle J-P, Picard N, Rousseau A, Guillaudeau A, Munteanu E, et al. *Donor P-gp polymorphisms strongly influence renal function and graft loss in a cohort of renal transplant recipients on cyclosporine therapy in a long-term follow-up. Clin Pharmacol Ther. 2010 Jul;88(1):95–100.*
103. Hebert MF, Dowling AL, Gierwatowski C, Lin YS, Edwards KL, Davis CL, et al. *Association between ABCB1 (multidrug resistance transporter) genotype and post-liver transplantation renal dysfunction in patients receiving calcineurin inhibitors. Pharmacogenetics. 2003 Nov;13(11):661–74.*
104. Elens L, Capron A, Kerckhove VV, Lerut J, Mourad M, Lison D, et al. *1199G>A and 2677G>T/A polymorphisms of ABCB1 independently affect tacrolimus concentration in hepatic tissue after liver transplantation. Pharmacogenet Genomics. 2007 Oct;17(10):873–83.*
105. Gómez-Bravo MA, Salcedo M, Fondevila C, Suarez F, Castellote J, Rufian S, et al. *Impact of donor and recipient CYP3A5 and ABCB1 genetic polymorphisms on tacrolimus dosage requirements and rejection in Caucasian Spanish liver transplant patients. J Clin Pharmacol. 2013 Nov;53(11):1146–54.*
106. Yamauchi A, Ieiri I, Kataoka Y, Tanabe M, Nishizaki T, Oishi R, et al. *Neurotoxicity induced by tacrolimus after liver transplantation: relation to genetic polymorphisms of the ABCB1 (MDR1) gene. Transplantation. 2002 Aug 27;74(4):571–2.*
107. Provenzani A, Notarbartolo M, Labbozzetta M, Poma P, Vizzini G, Salis P, et al. *Influence of CYP3A5 and ABCB1 gene polymorphisms and other factors on tacrolimus dosing in Caucasian liver and kidney transplant patients. Int J Mol Med. 2011 Dec;28(6):1093–102.*
108. Provenzani A, Santeusano A, Mathis E, Notarbartolo M, Labbozzetta M, Poma P, et al. *Pharmacogenetic considerations for optimizing tacrolimus dosing in liver and kidney transplant patients. World J Gastroenterol WJG. 2013 Dec 28;19(48):9156–73.*



109. Kuehl P, Zhang J, Lin Y, Lamba J, Assem M, Schuetz J, et al. Sequence diversity in CYP3A promoters and characterization of the genetic basis of polymorphic CYP3A5 expression. *Nat Genet.* 2001 Apr;27(4):383–91.
110. Guy-Viterbo V, Baudet H, Elens L, Haufroid V, Lacaille F, Girard M, et al. Influence of donor-recipient CYP3A4/5 genotypes, age and fluconazole on tacrolimus pharmacokinetics in pediatric liver transplantation: a population approach. *Pharmacogenomics.* 2014 Jun;15(9):1207–21.
111. Hesselink DA, Bouamar R, Elens L, van Schaik RHN, van Gelder T. The role of pharmacogenetics in the disposition of and response to tacrolimus in solid organ transplantation. *Clin Pharmacokinet.* 2014 Feb;53(2):123–39.
112. Uesugi M, Kikuchi M, Shinke H, Omura T, Yonezawa A, Matsubara K, et al. Impact of cytochrome P450 3A5 polymorphism in graft livers on the frequency of acute cellular rejection in living-donor liver transplantation. *Pharmacogenet Genomics.* 2014 Jul;24(7):356–66.
113. Rojas LE, Herrero MJ, Bosó V, García-Eliz M, Poveda JL, Librero J, et al. Meta-analysis and systematic review of the effect of the donor and recipient CYP3A5 6986A>G genotype on tacrolimus dose requirements in liver transplantation. *Pharmacogenet Genomics.* 2013 Oct;23(10):509–17.
114. Tang H-L, Xie H-G, Yao Y, Hu Y-F. Lower tacrolimus daily dose requirements and acute rejection rates in the CYP3A5 nonexpressers than expressers. *Pharmacogenet Genomics.* 2011 Nov;21(11):713–20.
115. Li D, Lu W, Zhu J-Y, Gao J, Lou Y-Q, Zhang G-L. Population pharmacokinetics of tacrolimus and CYP3A5, MDR1 and IL-10 polymorphisms in adult liver transplant patients. *J Clin Pharm Ther.* 2007 Oct;32(5):505–15.
116. Uesugi M, Masuda S, Katsura T, Oike F, Takada Y, Inui K. Effect of intestinal CYP3A5 on postoperative tacrolimus trough levels in living-donor liver transplant recipients. *Pharmacogenet Genomics.* 2006 Feb;16(2):119–27.
117. Fukudo M, Yano I, Yoshimura A, Masuda S, Uesugi M, Hosohata K, et al. Impact of MDR1 and CYP3A5 on the oral clearance of tacrolimus and tacrolimus-related renal dysfunction in adult living-donor liver transplant patients. *Pharmacogenet Genomics.* 2008 May;18(5):413–23.
118. Gérard C, Stocco J, Hulin A, Blanchet B, Verstuyft C, Durand F, et al. Determination of the most influential sources of variability in tacrolimus trough blood concentrations in adult liver transplant recipients: a bottom-up approach. *AAPS J.* 2014 May;16(3):379–91.



119. Jalil MHA, Hawwa AF, McKiernan PJ, Shields MD, McElnay JC. Population pharmacokinetic and pharmacogenetic analysis of tacrolimus in paediatric liver transplant patients. *Br J Clin Pharmacol*. 2014 Jan;77(1):130–40.
120. Shi Y, Li Y, Tang J, Zhang J, Zou Y, Cai B, et al. Influence of CYP3A4, CYP3A5 and MDR-1 polymorphisms on tacrolimus pharmacokinetics and early renal dysfunction in liver transplant recipients. *Gene*. 2013 Jan 10;512(2):226–31.
121. Tapirdamaz Ö, Hesselink DA, el Bouazzaoui S, Azimpour M, Hansen B, van der Laan LJW, et al. Genetic variance in ABCB1 and CYP3A5 does not contribute toward the development of chronic kidney disease after liver transplantation. *Pharmacogenet Genomics*. 2014 Sep;24(9):427–35.
122. Xue F, Han L, Chen Y, Xi Z, Li Q, Xu N, et al. CYP3A5 genotypes affect tacrolimus pharmacokinetics and infectious complications in Chinese pediatric liver transplant patients. *Pediatr Transplant*. 2014 Mar;18(2):166–76.
123. Hesselink DA, Bouamar R, Elens L, van Schaik RHN, van Gelder T. The role of pharmacogenetics in the disposition of and response to tacrolimus in solid organ transplantation. *Clin Pharmacokinet*. 2014 Feb;53(2):123–39.
124. Elens L, van Schaik RH, Panin N, de Meyer M, Wallemacq P, Lison D, et al. Effect of a new functional CYP3A4 polymorphism on calcineurin inhibitors' dose requirements and trough blood levels in stable renal transplant patients. *Pharmacogenomics*. 2011 Oct;12(10):1383–96.
125. Lai M, Brun D, Edelstein SJ, Le Novère N. Modulation of calmodulin lobes by different targets: an allosteric model with hemiconcerted conformational transitions. *PLoS Comput Biol*. 2015 Jan;11(1):e1004063.
126. San Segundo D, Millán O, Muñoz-Cacho P, Boix F, Paz-Artal E, Talayero P, et al. High proportion of pretransplantation activated regulatory T cells (CD4⁺CD25^{high}CD62L⁺CD45RO⁺) predicts acute rejection in kidney transplantation: results of a multicenter study. *Transplantation*. 2014 Dec 15;98(11):1213–8.
127. Kalina T, Flores-Montero J, van der Velden VHJ, Martin-Ayuso M, Böttcher S, Ritgen M, et al. EuroFlow standardization of flow cytometer instrument settings and immunophenotyping protocols. *Leukemia*. 2012 Sep;26(9):1986–2010.
128. Foster B, Prussin C, Liu F, Whitmire JK, Whitton JL. Detection of intracellular cytokines by flow cytometry. *Curr Protoc Immunol Ed John E Coligan Al*. 2007 Aug;Chapter 6:Unit 6.24.



129. Barten MJ, Gummert JF, van Gelder T, Shorthouse R, Morris RE. Flow cytometric quantitation of calcium-dependent and -independent mitogen-stimulation of T cell functions in whole blood: inhibition by immunosuppressive drugs in vitro. *J Immunol Methods*. 2001 Jul 1;253(1-2):95–112.
130. Wolf MJ, Adili A, Piotrowitz K, Abdullah Z, Boege Y, Stemmer K, et al. Metabolic activation of intrahepatic CD8+ T cells and NKT cells causes nonalcoholic steatohepatitis and liver cancer via cross-talk with hepatocytes. *Cancer Cell*. 2014 Oct 13;26(4):549–64.
131. Sewell AK. Why must T cells be cross-reactive? *Nat Rev Immunol*. 2012 Sep;12(9):669–77.
132. Böhler T, Canivet C, Nguyen PNL, Galvani S, Thomsen M, Durand D, et al. Cytokines correlate with age in healthy volunteers, dialysis patients and kidney-transplant patients. *Cytokine*. 2009 Mar;45(3):169–73.
133. Prémaud A, Rousseau A, Johnson G, Canivet C, Gandia P, Muscari F, et al. Inhibition of T-cell activation and proliferation by mycophenolic acid in patients awaiting liver transplantation: PK/PD relationships. *Pharmacol Res Off J Ital Pharmacol Soc*. 2011 May;63(5):432–8.
134. Fukudo M, Yano I, Masuda S, Okuda M, Inui K-I. Distinct inhibitory effects of tacrolimus and cyclosporin a on calcineurin phosphatase activity. *J Pharmacol Exp Ther*. 2005 Feb;312(2):816–25.
135. Maes BD, Vanrenterghem YFC. Cyclosporine: advantages versus disadvantages vis-à-vis tacrolimus. *Transplant Proc*. 2004 Mar;36(2 Suppl):40S – 49S.
136. Webster A, Woodroffe RC, Taylor RS, Chapman JR, Craig JC. Tacrolimus versus cyclosporin as primary immunosuppression for kidney transplant recipients. *Cochrane Database Syst Rev*. 2005;(4):CD003961.
137. Choudhary NS, Saigal S, Shukla R, Kotecha H, Saraf N, Soin AS. Current status of immunosuppression in liver transplantation. *J Clin Exp Hepatol*. 2013 Jun;3(2):150–8.
138. Duvoux C, Firpi R, Grazi GL, Levy G, Renner E, Villamil F. Recurrent hepatitis C virus infection post liver transplantation: impact of choice of calcineurin inhibitor. *Transpl Int Off J Eur Soc Organ Transplant*. 2013 Apr;26(4):358–72.
139. Haddad EM, McAlister VC, Renouf E, Malthaner R, Kjaer MS, Gluud LL. Cyclosporin versus tacrolimus for liver transplanted patients. *Cochrane Database Syst Rev*. 2006;(4):CD005161.



140. Wang H, Daniel V, Sadeghi M, Opelz G. Differences in the induction of induced human CD4(+) CD25(+) FoxP3(+) T-regulatory cells and CD3(+) CD8(+) CD28(-) T-suppressor cells subset phenotypes in vitro: comparison of phorbol 12-myristate 13-acetate/ionomycin and phytohemagglutinin stimulation. *Transplant Proc.* 2013 Jun;45(5):1822–31.
141. Pelchen-Matthews A, Parsons IJ, Marsh M. Phorbol ester-induced downregulation of CD4 is a multistep process involving dissociation from p56lck, increased association with clathrin-coated pits, and altered endosomal sorting. *J Exp Med.* 1993 Oct 1;178(4):1209–22.
142. O'Neil-Andersen NJ, Lawrence DA. Differential modulation of surface and intracellular protein expression by T cells after stimulation in the presence of monensin or brefeldin A. *Clin Diagn Lab Immunol.* 2002 Mar;9(2):243–50.
143. Hennessy B, North J, Deru A, Llewellyn-Smith N, Lowdell MW. Use of Leu3a/3b for the accurate determination of CD4 subsets for measurement of intracellular cytokines. *Cytometry.* 2001 Jun 1;44(2):148–52.
144. Davis BH, Wood B, Oldaker T, Barnett D. Validation of cell-based fluorescence assays: practice guidelines from the ICSH and ICCS - part I - rationale and aims. *Cytometry B Clin Cytom.* 2013 Oct;84(5):282–5.
145. McNeil LK, Price L, Britten CM, Jaimes M, Maecker H, Odunsi K, et al. A harmonized approach to intracellular cytokine staining gating: Results from an international multiconsortia proficiency panel conducted by the Cancer Immunotherapy Consortium (CIC/CRI). *Cytom Part J Int Soc Anal Cytol.* 2013 Aug;83(8):728–38.
146. Maecker HT, Rinfret A, D'Souza P, Darden J, Roig E, Landry C, et al. Standardization of cytokine flow cytometry assays. *BMC Immunol.* 2005;6:13.
147. Böhler T, Nolting J, Kamar N, Gurragchaa P, Reisener K, Glander P, et al. Validation of immunological biomarkers for the pharmacodynamic monitoring of immunosuppressive drugs in humans. *Ther Drug Monit.* 2007 Feb;29(1):77–86.
148. Brandt C, Liman P, Bendfeldt H, Mueller K, Reinke P, Radbruch A, et al. Whole blood flow cytometric measurement of NFATc1 and IL-2 expression to analyze cyclosporine A-mediated effects in T cells. *Cytom Part J Int Soc Anal Cytol.* 2010 Jul;77(7):607–13.
149. Sommerer C, Konstandin M, Dengler T, Schmidt J, Meuer S, Zeier M, et al. Pharmacodynamic monitoring of cyclosporine a in renal allograft recipients shows a



quantitative relationship between immunosuppression and the occurrence of recurrent infections and malignancies. *Transplantation*. 2006 Nov 27;82(10):1280–5.

150. Kung L, Batiuk TD, Palomo-Pinon S, Noujaim J, Helms LM, Halloran PF. Tissue distribution of calcineurin and its sensitivity to inhibition by cyclosporine. *Am J Transplant Off J Am Soc Transplant Am Soc Transpl Surg*. 2001 Nov;1(4):325–33.
151. Sommerer C, Meuer S, Zeier M, Giese T. Calcineurin inhibitors and NFAT-regulated gene expression. *Clin Chim Acta Int J Clin Chem*. 2012 Sep 8;413(17-18):1379–86.
152. Taupin JL, Merville P, McBride T, Potaux L, Moreau JF. Functional quantification of cyclosporine A and FK506 in human whole blood by flow cytometry, using the green fluorescent protein as an interleukin-2 reporter gene. *J Immunol Methods*. 2001 Oct 1;256(1-2):77–87.
153. Lemaitre F, Blanchet B, Latournerie M, Antignac M, Houssel-Debry P, Verdier M-C, et al. Pharmacokinetics and pharmacodynamics of tacrolimus in liver transplant recipients: inside the white blood cells. *Clin Biochem*. 2015 Jan 3;
154. Sood S, Testro AG. Immune monitoring post liver transplant. *World J Transplant*. 2014 Mar 24;4(1):30–9.
155. He Q, Fan H, Li JQ, Qi HZ. Decreased circulating CD4+CD25highFoxp3+ T cells during acute rejection in liver transplant patients. *Transplant Proc*. 2011 Jun;43(5):1696–700.
156. Stenard F, Nguyen C, Cox K, Kambham N, Umetsu DT, Krams SM, et al. Decreases in circulating CD4+CD25hiFOXP3+ cells and increases in intra-graft FOXP3+ cells accompany allograft rejection in pediatric liver allograft recipients. *Pediatr Transplant*. 2009 Feb;13(1):70–80.
157. Lu H, Ouyang W, Huang C. Inflammation, a key event in cancer development. *Mol Cancer Res MCR*. 2006 Apr;4(4):221–33.
158. Del Prete A, Allavena P, Santoro G, Fumarulo R, Corsi MM, Mantovani A. Molecular pathways in cancer-related inflammation. *Biochem Medica*. 2011;21(3):264–75.



Abbreviations

- *ABCB1, ATP-binding cassette, sub-family B member 1 = P-gp permeability glycoprotein 1= MDR1 multidrug resistance protein 1*
- *ACR, acute celular rejection*
- *AICD, activation induced cell death*
- *AIP, calcineurin C-terminal autoinhibitory peptide*
- *AKAP79, A-kinase anchor protein 79*
- *AKAPs, A-kinase-anchoring proteins*
- *ANOVA, analysis of variance*
- *AP1, activator protein 1*
- *APC, allophycocyanin*
- *APC, antigen-presenting cells*
- *ARRE, antigen-receptor response element*
- *ATF-2, activating transcription factor 2*
- *ATP, adenosine triphosphate*
- *AUC, area under the concentration-time curve*
- *BBH, CaNB binding helical domain*
- *BCR, B cell receptor*
- *BLIMP1, B lymphocyte-induced maturation protein 1*
- *BLYS, B lymphocyte stimulator*
- *BM, biomarker*
- *C4d, complement degradation product*



- *CABIN1* or *CAIN*, calcineurin-binding protein 1
- *CALM1*: calmodulin 1 (phosphorylase kinase, delta)
- *CaM*, calmodulin
- *CaMK*, calmodulin-dependent kinases
- *CaMKII*, calmoduline dependent protein kinase II
- *CAMKIV*, Ca^{2+} /CaM/calmodulin dependent kinase IV
- *CaN* (*PP2B*), calcineurin
- *CaNA*, calcineurin catalytic subunit
- *CaNB*, calcineurin regulatory subunit
- *CANB1*, calcineurin regulatory subunit, isoform 1
- *CaNB2*, calcineurin regulatory subunit, isoform 2
- *CBF β* , core binding factor- β complex
- *CBL-B*, casitas B-lineage lymphoma B
- *CBP*, CREB binding protein
- *CCR5*, Chemokine Receptor 5
- *CD122*, *IL2R β*
- *CD132*, *IL2R γ c*
- *CD25*, *IL2R α*
- *Cdk2*, cyclin-dependent kinase 2
- *Cdk4*, cyclin-dependent kinase 4
- *CK1*, casein kinase 1
- *CML*, chronic myeloid leukaemia



- *C-MYC, V-myc avian myelocytomatosis viral oncogene homolog*
- *CNBR2, CaN binding region 2*
- *CNIs, calcineurin drugs inhibitors*
- *CNS, conserved non coding sequences*
- *CO₂, carbon dioxide*
- *ConA, concanavalin A*
- *COX-2, cyclooxygenase -2*
- *CRAC, calcium release activated channels*
- *CREB, cyclic AMP-responsive element-binding protein*
- *CRM1, chromosomal region maintenance 1*
- *CsA, cyclosporine A*
- *CSF, colony stimulating factor*
- *CSPs, calcipressins*
- *CTL, cytotoxic T lymphocytes*
- *CTLA-4, cytotoxic T-lymphocyte antigen 4*
- *CXCL8, CXC-chemokine ligand 8*
- *CYP3A4, cytochrome P450 3A4*
- *CYP3A5, cytochrome P450 3A5*
- *CypA, cyclophilin A*
- *CypB, cyclophilin B*
- *CypC, cyclophilin C*
- *CypE cyclophilin E*
- *CyPs, cyclophilins*



- *DAG, diacylglycerol*
- *DC, dendritic cells*
- *DGK α , diacylglycerol kinase- α*
- *dim, diminished fluorescence of cell population*
- *DN, double negative*
- *DP, double positive*
- *DRE, downstream regulatory element*
- *DREAM or calsenilin/KChIP-3 K⁺ channel interacting protein 3, downstream regulatory element antagonist modulator*
- *DSA, donor specific antibody*
- *DSCR1, Down's syndrome critical region 1*
- *DSCR1/MCIP1, Down syndrome critical region protein 1/Myocyte enriched calcineurin-interacting protein-1*
- *DTX1, deltex 1protein*
- *DYRK1, dual-specificity tyrosine-phosphorylation regulated kinase 1*
- *DYRK2, dual-specificity tyrosine-phosphorylation regulated kinase 2*
- *ϵ -CREM, cAMP-response element modulator*
- *EDGR, LPA receptor*
- *Egr2, early growth response 2 protein*
- *ELF1, lymphoid/myeloid-specific ETS family protein*
- *ELK-1, member of ETS oncogene family*
- *EMT, epithelial to mesenchymal transition*
- *ENNP2, exonucleotide pyrophosphatase and phosphodiesterase 2*



- *ER, endoplasmic reticulum*
- *ERK, extracellular-signal-regulated kinases*
- *FBS, fetal bovine serum*
- *FCS, forward-scattered light*
- *FITC, fluorescein isothiocyanate*
- *FKBP1A, FK506 binding protein 1A, 12 kDa*
- *FKBPs, TAC binding proteins*
- *FOXC2, forkhead box protein C2*
- *FOXJ1, Forkhead box protein J1*
- *FOXO3A, Forkhead box O3*
- *FOXP2, forkhead box P protein winged helix 2*
- *FOXP3, forkhead box P protein winged helix 2*
- *FSC-A, forward scatter area*
- *FSC-H, forward scatter height*
- *GATA3, GATA-binding protein 3*
- *GITR, glucocorticoid-induced TNF receptor*
- *GM-CSF, granulocyte-macrophage colony-stimulating factor*
- *GRAIL, gene related to anergy in lymphocytes*
- *GRG4, groucho-related gene 4*
- *GSK3, glycogen-synthase kinase 3*
- *HAT, histone acetyltransferase*
- *HBV, hepatitis B virus*



- *HCC, hepatocellular carcinoma*
- *HCV, hepatitis C virus*
- *HDACs, histone deacetylases*
- *HMG-I(Y), high mobility group proteins*
- *I, ionomycin calcium salt*
- *I₀, basal level of the biomarker in the absence of calcineurin inhibitor but under stimulated conditions*
- *IC, immunological capacity*
- *IC₅₀, half maximal inhibitory concentration*
- *ICCS, International Clinical Cytometry Society*
- *ICER, inducible cyclic AMP early repressor*
- *ICSH, International Council for Standardization of Hematology IDP, intrinsically disordered proteins*
- *IFN γ , interferon gamma*
- *IK1, intermediate conductance calcium-activated potassium channel protein 1 channels*
- *IKAROS, IKZF1 family zinc finger 1*
- *IKK, inhibitor of NF- κ B (I κ B) kinase*
- *IL-2, interleukin 2*
- *IL-2R α (CD25), interleukin 2 receptor alpha subunit*
- *I_{max}, maximal response induced by TAC or CsA*
- *IP3, inositol-1,4,5-trisphosphate*
- *IP3R, inositol-1,4,5-trisphosphate receptor*



- *IQ motif, calmodulin binding motif*
- *IQGAP, IQ motif with GTPase activating protein*
- *IRF4, IFN-regulatory factor 4*
- *IS, immunosuppressive drugs*
- *ITCH, itchy homologue E3 ubiquitin protein ligase*
- *Itk, IL-2 tyrosine kinase*
- *ITT, intention-to-treat*
- *IκB, inhibitor proteins IκappaB*
- *JAK, janus kinase*
- *JNK, c-JUN N-terminal kinase*
- *JUN, jun proto-oncogene*
- *KT, Kidney transplant*
- *LCK, Tyrosine-protein kinase LCK*
- *LD, linkage disequilibrium*
- *LDT, laboratory developed tests*
- *LFA1, lymphocyte function-associated antigen 1*
- *LKLF, lung Kuppel like transcription factor*
- *LOD/LOB, limit of detection / limit of blank*
- *LPA, lysophosphatidic acid*
- *LPS, lipopolysaccharide*
- *LRRK2, leucine rich repeat kinase 2*
- *LT, liver transplantation*



- *LTP, liver transplant patients*
- *LTR, liver transplant recipients*
- *MAF, minor allele frequency*
- *MAPK, mitogen-activated protein kinase*
- *MCU, mitochondrial Ca²⁺ uniporter*
- *MEF2, myocyte-specific enhancer factor 2*
- *MEKK, mitogen activated protein kinase kinase*
- *MFI, mean fluorescence intensity*
- *MHC, major histocompatibility complex*
- *MKP5, Mitogen-activated protein kinase phosphatase 5*
- *MKPs, Mitogen-activated protein kinase phosphatases*
- *NES, nuclear export sequence*
- *NF90, nuclear factor 90*
- *NFAT, nuclear factor of activated T cells*
- *NFAT1, isoform 1 of the nuclear factor of activated T-cells; NFATc2 (NFAT1), cytoplasmic 2 nuclear factor of activated T-cells;*
- *NFAT1, NFATp or NFATc2*
- *NFAT2, NFATc or NFATc1*
- *NFAT2Aα, NFAT2 isoform A alpha*
- *NFAT3, NFATc4*
- *NFAT4, NFATx or NFATc3*
- *NFAT5, TonEBP or OREBP*
- *NFATc1, nuclear factor of activated T-cells, cytoplasmic, calcineurin-dependent 1*



- *NFκB, nuclear factor kappa light chain enhancer of activated B cells*
- *NHR, NFAT-homology region*
- *NK, natural killer cells*
- *NKT, natural killer T cells*
- *NLS, nuclear localization sequence*
- *NR2F6, nuclear receptor subfamily 2, group F, member 6*
- *NRON, long intergenic RNA non-coding repressor of NFAT*
- *NS, non stimulated*
- *NUR77, orphan nuclear receptor 77*
- *OCT, octamer-binding transcription factor*
- *ORAI1, pore forming subunit of the calcium release-activated calcium channel protein 1 channels*
- *p21SNFT, 21-kDa small nuclear factor isolated from T cells*
- *PARP1, poly-adenosine diphosphate-ribose polymerase 1*
- *PBMC, peripheral blood mononuclear cells*
- *PD, pharmacodynamic*
- *PE, phycoerythrin dye*
- *PE-Cy7, phycoerythrin and cyanine dye*
- *PerCP-Cy5.5, peridinin chlorophyll protein and cyanine dye*
- *PGE2, prostaglandin E2*
- *PGx, pharmacogenetics*
- *PIP2, phosphatidyl-4,5-bisphosphate*
- *PK, pharmacokinetics*



- *PKA, protein kinase A*
- *PKB/AKT, protein kinase B*
- *PKC, protein kinase C*
- *PLC β , phospholipase C β*
- *PLC γ , phospholipase C γ*
- *PMA, phorbol 12-myristate 13-acetate*
- *PMCA, plasma membrane Ca²⁺-ATPase*
- *PPAR- γ , peroxisome proliferator-activated receptor- γ*
- *PPIA, peptidylprolyl isomerase A (cyclophilin A)*
- *PPIs, immunophilins*
- *PPP3CA, protein phosphatase 3, catalytic subunit, α isozyme*
- *PPP3CB, protein phosphatase 3, catalytic subunit, β isozyme*
- *PPP3R1, protein phosphatase 3, regulatory subunit B α*
- *PROX1, prospero-related homeobox gene 1*
- *PRRs, positive regulatory regions*
- *PTGER2, PGE2 receptor*
- *PTP1B, protein tyrosine phosphatase 1B*
- *RCAN1, calcipressin 1, CALP, Down syndrome candidate region 1 DSCR1, myocyte-enriched calcineurin-interacting protein 1(MCIP1) Adapt78*
- *RCAN2, DSCR1L1, MCIP2, ZAKI-4, or CALP2*
- *RCAN3, DSCR1L2, MCIP3, or CALP3*
- *RCANs, calcineurin regulator proteins*



- *RCH1, Rag cohort 1, also named LRR receptor-like serine/threonine-protein kinase receptor*
- *RFLP-PCR, restriction fragment length polymorphism*
- *RHR, REL-homology region*
- *RORyt, retinoic acid receptor-related orphan receptor-γt.*
- *RPTPκ, receptor-type protein tyrosine phosphatase-κ*
- *RTK, tyrosine kinases receptor*
- *RUNX1, runt-related transcription factor 1*
- *RyRs, ryanodine receptors*
- *SERCA, sarcoplasmic/endoplasmic reticulum Ca²⁺ ATPase*
- *SMAD3, STAT5 mothers against decapentaplegic homolog 3*
- *SNP, single nucleotide polymorphism*
- *SOCE, store-operated calcium entry*
- *SP motif, serine-proline motif*
- *SP, single positive*
- *SR, sarcoplasmic reticulum*
- *SRF, serum responsive factor*
- *SRIM2, stromal interaction molecule 2*
- *SRR, serine-rich region*
- *STAT, signal transducer and activator of transcription*
- *STIM1, stromal interaction molecule 1*
- *SUMO, small ubiquitin like modifier*
- *TAC, tacrolimus*



- *TAD, transactivation domain*
- *TAK1, Transforming growth factor beta-activated kinase 1*
- *T-ALL, T cell acute lymphoblastic leukemia*
- *T-bet, T box family transcription factors*
- *TCR, T cell receptor*
- *TF, transcription factor*
- *TGFβ, transforming growth factor beta*
- *TIE, TGFβ inhibitory element*
- *TKI, tyrosine kinase inhibitor*
- *TNF, tumour-necrosis factor*
- *Tregs, regulatory T cells*
- *TRPM4, transient receptor potential cation channel M4*
- *VEGFA, vascular endothelial growth factor A*
- *VNTR, variable number of tandem repeats*
- *WLT, waiting list for liver transplantation*
- *WLP, waiting list patients*



SUPPLEMENTAL MATERIALS

S1.STRATEGY for the STUDY of POLYMORPHISMS in NFAT and CALCINEURIN CRITICAL REGIONS of INTERACTION

S1.1.NFAT CRITICAL REGIONS OF INTERACTION WITH CaN and OTHER PROTEINS

Exon 2 maps of nucleotides sequences shows variants location in brilliant green and yellow. In light green is pointed CaN A binding region; in blue is delimited CaN B subunit binding region; in fucsia SRR1 region; in black SRR2 and NLS motifs; in red SP3 motif; underlined text corresponds to the site for AP1 interaction; in lowercase KTS motif; in yellow SRR2 and NLS motifs.

EXON 2

```
AACACTATGGCTATGCATCCTCCAAGGTCAGCCCGCCCTGCCCTCCCCACGGCGCACT
CCACCCCTGCCGGCCCGGTGCCACAACCTTCAGACCTCCACACCGGGCATCATCCCGCCGG
CGGATCACCCCTCGGGGTACGGAGCAGCTTTGGACGGTGGGCCCGGGGCTACTTCTCT
CCTCCGGCCACACCAGGCCTGATGGGGCCCTGCCCTGGAG [AGTCCTCGCATCGAGATAA
CC] TCGTGCTTGGGCCTGTACCACAACAATAACCAGTTTTTCCACGGATGTGGAGGTGGAAG
ACGTCTCCCTAGCTCCAAACGGTCCCCCTCCACGGCCACGCTGAGTCTGCCCAGCCTGG
AGGCC [TACAGAGACCCCTCCGTGCCCTGAGCCCGGCCAGCAGCCTGTCTCCCGGAGCTGCA
ACTCAGAGGCCTCCTCCTACGGAGTCCA] ACTACTCGTACCCGTACCGTCCCCCAGACCGT
CGCCATGGCAGTCTCCCTGCCCGTGTCTCCCAAGACCACGGACCCCGAGGAGGGCTTTCCCC
GCCGGGCTGGGGGCCTGCACACTCGTGGCGTTCCCCGCGACTCCCCCTCCACCTCCGCCCC
GCGCCAGCGTCACTGAGGAGAGCTGGGTGGGTGCCCGCTCCTCC [AGACCCCGGGTCCCCTCGT
GCAACAAGAGGAAGTACCGCCTCAACGGCCGGCAG] CCCGCCCTAC [TCACCCACCACTCGC
CCACGCCCGTCCCCCGCACGGCTCCCCCGGGTCACGCGTCGGACCGCGACT] ACTCGTGGTTGGGCA
ACACCACCCAGTACACCAGCTCGGCCATCGTGGCCGCCATCAACCGGCGCTGACCACCGACA
GCAGCCTGGACCTGGGAGATGGC [gtcctgtcaagtcccgaagaccacctgg]AGCAGC
CGCCCTCAGTGGCCGCTCAAGGTG [GAGCCCGTGCGGGGAGGACCGT] GGGCAGCCCCCGCCCC
CGGCCGACTTCGCCCGGAAGACTCGACTCGCTCTTTCCAGCACATCAGGAAGGGCGGCTTCT
GC [GACCAGTACCTGGCGGTGCCCGCAGACCCCTACCAGTGGCGAAGCCCAAGCCCCTGT
CCCC] TACGTCTTACATGAG
```



Calcineurin A Binding Region

Motif NFAT2: PxlIT = **SPRIEIT**, CPSIRIT, CPSIQIT

AGTCCTCGCATCGAGATAACC

Calcineurin B Binding Region

Motif: DQYLAVPQH-P-YQWAKPKPLSP

GACCAGTACCTGGCGGTGCCGAGCACCCCTACCAGTGGGCGAAGCCCAAGCCCCTGTCCC

Serine Rich Region 1

SRR1: **SPASSGSSASFISD**

SRR1: **GYRESPASSGSSASFISDTF**

SRR1: YRDPSCLS**PASSLSSRSCNSE** reference seq

**TACAGAGACCCCTCGTGCCTGACCCGGCCAGCAGCCTGTCTCCCGCCAGCTGCAACTCAGAGG
CCTCCTCCTACGAGTCCA**

- *rs 146706357*
- *rs140225213*

Serine Rich Region 2 and Nuclear Localization Sequence

SRR-2 / NLS: **RPASRSSSPGAKRRHS**

SRR-2 / NLS: **RPASPCNKRKYSLNGRQ** reference sequence

AGACCCGCGTCCCCTGAACAAGAGGAAGTACAG

- *rs 139169385*
- *rs 2230112*
- *rs 112028090*



Serine Repeat Motif 1

SP1:SPQTSPWQSPCVSPKTTDPEE

Serine Repeat Motif 2

SP2: SPRTSPIMSPRT

SP2: TLLGSPQHSPISTSPRASVTEE

SP2 : SPQTSPWQSPCVSPKTTD reference sequence

TCCCCCAGACGTCGCCATGGCAGTCTCCCTGCGTGTCTCCCAAGACCACGGA

Serine Repeat Motif 3

SP3: SPQRSRSPSPQSP

SP3: SPQRSRSPSPQSPHVAPQDD

SP3: SPHHSPTPSHGSPRVSVTDD

SP3: SPHHSPTPSHGSPRVSVTDD reference sequence

TCACCCCACTCGCCACGCCGTCCCGCACGGCTCCCGCGGGTCAGCGTGACCGAGG

- *rs 1063670*
- *rs 142009203*
- *rs 150655822*
- *rs 139882199*
- *rs 76525142*

KTS motif

KTS: VPVKSRKTLE

KTS: VPVKSRKTLE reference sequence

gtccctgtcaagtcccgaagaccaccctgg



Activator Protein 1

AP1: **ELRKGETDIG**

AP1: *EPVGEDL* reference sequence

GAGCCCGTCGGGGAGGACCT?

- *rs 139217071*
- *rs 143975184*

Interleukin 2

IL2: **AGGAAAAC**

IL2 ARRE2: **AGGAAAaacTGttTCA**



S1.2.PPP3CA CRITICAL REGIONS OF INTERACTION WITH NFAT and OTHER PROTEINS

Exons 9 to 14 were identified as containing critical motifs of interaction with NFAT, calmodulin, immunophilins and autoinhibitory peptide. A similar strategy as that described for NFAT was applied to identify motifs and variants in the mapped exons.

EXON 9

CTGCAGTATTGAAGTATGAGAACAATGTTATGAATATCAGGCAATTCAACTGTTCTCCTC
ATCCATACTGGCTTCCAAATTCATG**[GATGTTTTACTTGGTCCCTTCCATTTGTTGGGG
AAAAAG]**

EXON 10

[TGACTGAGATGCTGGTAAATG]TCCTCAACATCTGCTCAGATGATGAACTAGGGTCAG
AAGAAGATGGATTTGATG

EXON 11

GTGCAACAGCTGCA**[GCCCGAAAGAGGTGATAAGGAACAAGATCCGAGCAATAGGC
AAAATGGCCAGAGTGTCTCA]**GTGCTCAG

EXON 14

CTATCAAAGGATTTCC**ACCACAACATAAG[ATCACTAGCTTCGAGGAAGCCAAGGGCTT
AGACCGAATTAATGAGAGGATGCCSCTCGCAGAGATGCCAT]**GCCCTCTGACGCCAA
CCTTAACTCCATCAACAAGGCTCTCACCTCAGAGACTAACGGCACGGACAGCAATGGCA
GTAATAGCAGCAATATTCAAGTGA



CaN Catalytic Domain - Residues 210 to 999

CaN Regulatory Domain - Residues 999 to 1399

Calcineurin B Binding Helix – residues 348 to 368

DVFTWSLPFVGEKVTEMLVNV

Critical interaction with CyPA and FKBP1A

GATGTTTTACTTGGTCCCTTCCATTTGTTGGGGAAAAAGTGACTGAGATGCTGGTAAATG

EXON 9 y 10

- rs 78927351

Calmodulin Binding Domain – residues 391 to 414

ARKEVIRNKIRAIGKMARVFSVLR

GCCCGAAAGAGGTGATAAGGAACAAGATCCGAGCAATAGGCAAATGGCCAGAGTGTCT
CAGTGCTCA

EXON 11

Autoinhibitory Domain– residues 468 to 490

ITSFEEAKGLDRINERMPPRRDAM

ATCACTAGCTTCGAGGAAGCCAAGGGCTTAGACCGAATTAATGAGAGGATGCCGCCTCGCAG
AGATGCCAT



EXON 14

- *rs 150423845*
- *rs 140517920*

Autoinhibitory Peptide

Residue 470

TCG

**ATCACTAGCTTCGAGGAAGCCAAGGGCTTAGACCGAATTAATGAGAGGATGCCGCCTCGCAG
AGATGCCAT**



S2.FLOW CYTOMETRY GATING STRATEGY

S2.1.NFAT1 in PBMC Nuclei

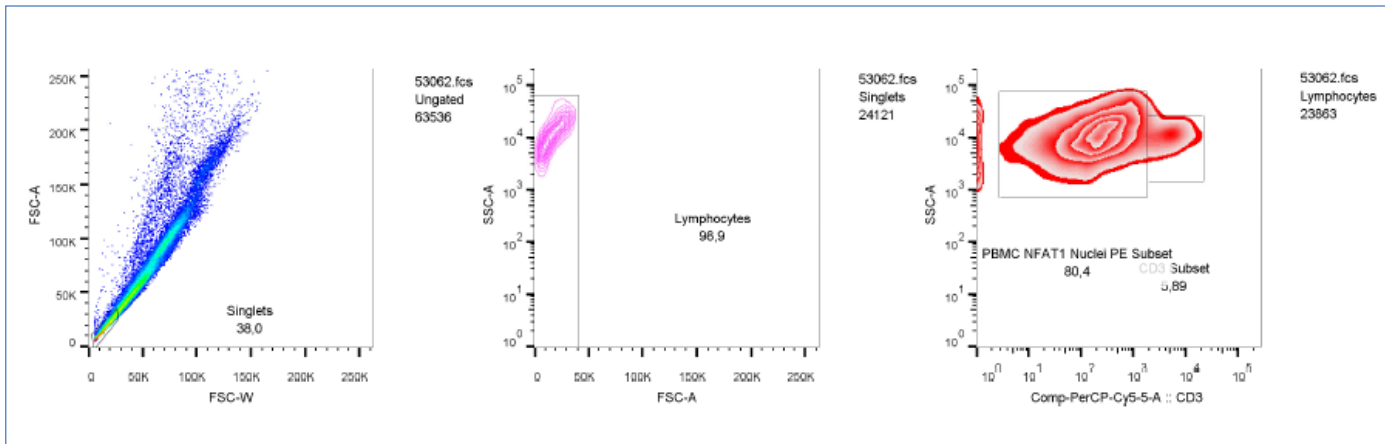

S2.2.Intracellular IL-2 in CD4+ and CD8+ T cell subsets

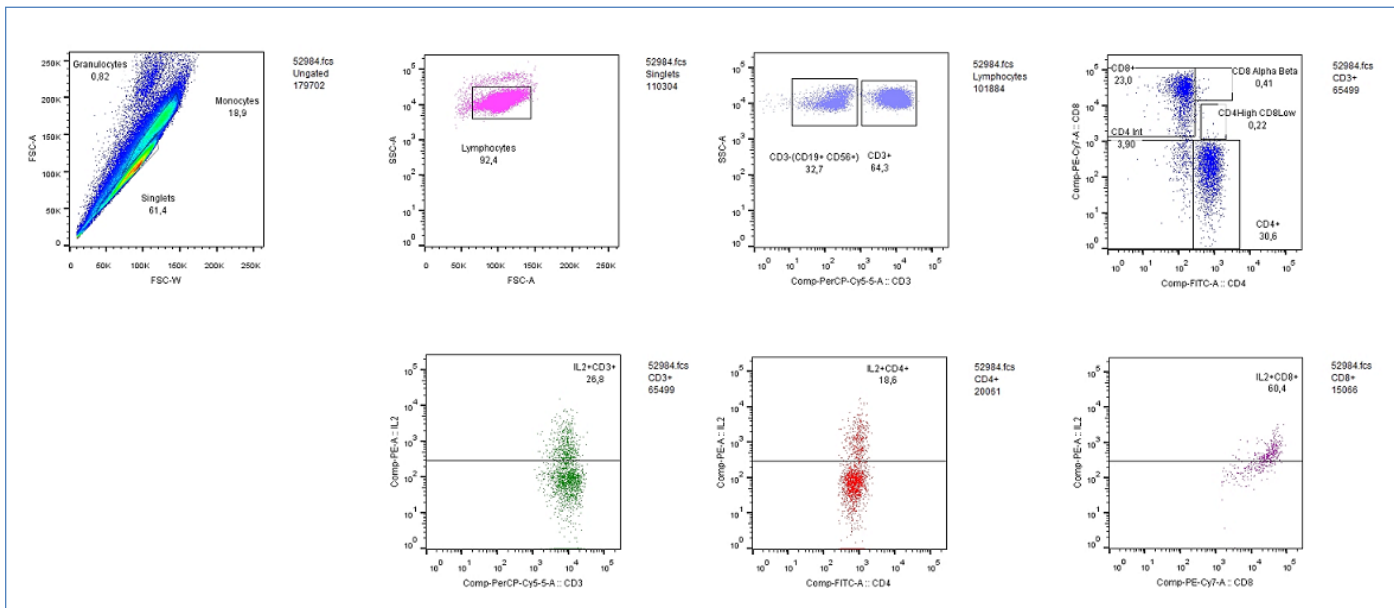

S2.3. CD25^{High} in CD3^{dim}, CD4^{dim} and CD8^{dim} T cell subsets

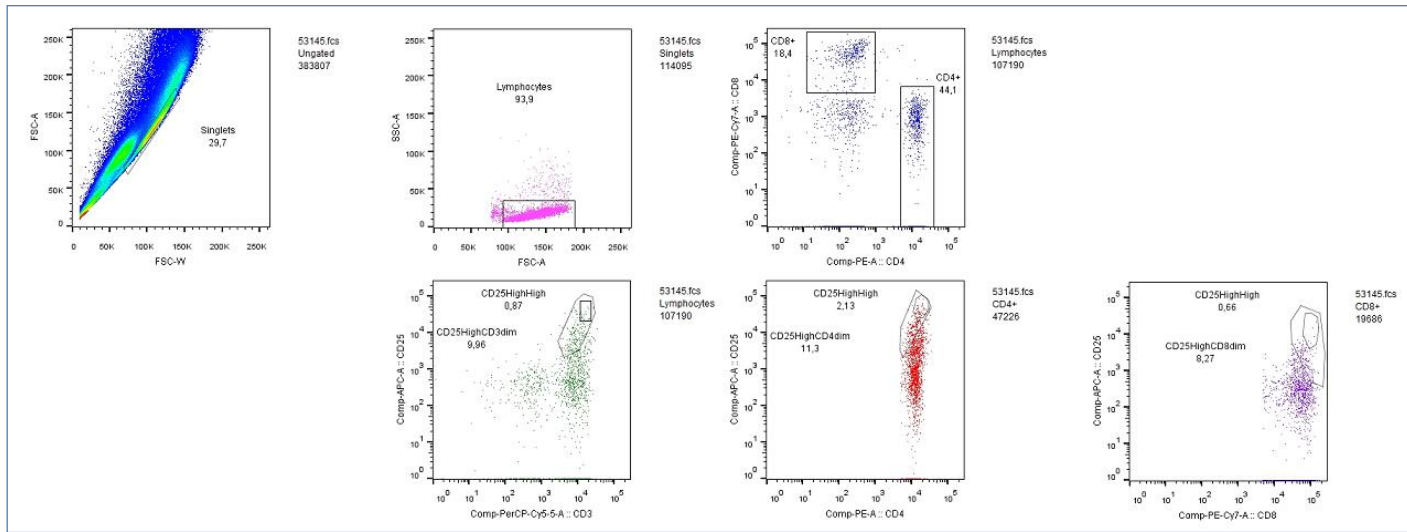

S3. PUBLISHED ARTICLE about EX-VIVO TACROLIMUS PHARMACODYNAMICS in HEALTHY VOLUNTEERS' PBMC.

Clinical Chemistry 60:10
1336–1345 (2014)

Drug Monitoring and Toxicology

Tacrolimus Pharmacodynamics and Pharmacogenetics along the Calcineurin Pathway in Human Lymphocytes

Ofelia M. Noceti,^{1,2,3} Jean-Baptiste Woillard,¹ Ahmed Boumediene,⁴ Patricia Esperón,³ Jean-Luc Taupin,⁵
Solange Gerona,² Marcelo Valverde,² Cristina Touriño,⁶ and Pierre Marquet^{1*}

PMID: 25142246

Abstract

BACKGROUND: Although therapeutic drug monitoring has improved the clinical use of immunosuppressive drugs, there is still inter-patient variability in efficacy and toxicity that pharmacodynamic monitoring may help to reduce. To select the best biomarkers of tacrolimus pharmacodynamics, we explored the strength and variability of signal transduction and the influence of polymorphisms along the calcineurin pathway.

METHODS: Peripheral blood mononuclear cells (PBMCs) from 35 healthy volunteers were incubated with tacrolimus (0.1-50 ng/ml) and stimulated ex vivo. Inhibition of NFAT1 translocation to the nucleus, intracellular expression of IL-2 in CD4⁺ and CD8⁺ T cells, and the surface activation marker CD25 on CD3⁺ cells were measured by flow cytometry.

The promoter regions of immunophilines and calcineurin subunits were sequenced and selected SNPs in the genes of the calcineurin pathway were characterized using allelic discrimination assays.



RESULTS: All responses closely fitted an I/I_{\max} sigmoid model. Large inter-individual variability ($n=30$) in I_0 and IC_{50} was found for all biomarkers. Moreover, strong and statistically significant associations were found between tacrolimus pharmacodynamic parameters and polymorphisms in the genes coding cyclophilin A, the calcineurin catalytic subunit alpha isozyme and CD25.

CONCLUSIONS: This study demonstrates the consistency and large inter-individual variability of signal transduction along the calcineurin pathway, as well as the strong influence of pharmacogenetic polymorphisms in the calcineurin cascade on both the physiological activity of this route and TAC pharmacodynamics.



S4.TAC INDIVIDUAL PD PARAMETERS in WLP

Table S4.1. Tacrolimus individual PD parameters in patients of the LT waiting list.

[NS (physiological levels, unstimulated reading); I_0 (basal measurement without TAC exposure ex-vivo but in stimulated conditions); IC_{50} (TAC 50% inhibitory concentration); I_{max} (TAC maximal inhibition)].

WLP1

PK	NFAT1	IL2CD4	IL2CD8	CD25CD3	CD25CD4	CD25CD8
NS	101	0.1	20	ND*	ND*	ND*
I_0	242	42	42	ND*	ND*	ND*
IC_{50}	0.55	0.28	0.63	ND*	ND*	ND*
R^2	0.9017	0.9998	1.000	ND*	ND*	ND*
I_{max}	85	1.0	89	ND*	ND*	ND*

ND*, not enough lymphocytes for the study.

WLP2

PK	NFAT1	IL2CD4	IL2CD8	CD25CD3	CD25CD4	CD25CD8
NS	125	0.3	15	3.5	5.9	0.1
I_0	160	18	2.3	5.4	6.8	1.6
IC_{50}	ND*	0.36	0.11	22	0.91	2.6
R^2	ND*	0.9987	0.9997	0.9433	0.9981	0.9950
I_{max}	90	1.1	22	52	41	6.3

WLP3

PK	NFAT1	IL2CD4	IL2CD8	CD25CD3	CD25CD4	CD25CD8
NS	ND*	0	0	ND	ND	ND
I_0	48	25	4.6	9.3	10	3.5
IC_{50}	0.72	0.96	1.1	4.2	2.4	5.8
R^2	0.9976	0.9646	0.9908	0.9899	0.9841	0.9808
I_{max}	47	0.4	0	12	3.8	0



WLP4

PK	NFAT1	IL2CD4	IL2CD8	CD25CD3	CD25CD4	CD25CD8
NS	ND	0.2	0.1	ND*	ND*	ND*
I_0	104	13	7.6	ND*	ND*	ND*
IC_{50}	ND	0.42	0.25	ND*	ND*	ND*
R^2	ND	0.9730	0.9755	ND*	ND*	ND*
I_{max}	62	0.7	0	ND*	ND*	ND*

WLP5

PK	NFAT1	IL2CD4	IL2CD8	CD25CD3	CD25CD4	CD25CD8
NS	278	0	38	1.3	2.2	0
I_0	559	27	19	49	44	17
IC_{50}	3.2	16	15	0.3	0.75	6.1
R^2	0.9715	0.9995	0.9993	0.9779	0.9973	1.000
I_{max}	71	0.1	25	35	40	25

WLP6

PK	NFAT1	IL2CD4	IL2CD8	CD25CD3	CD25CD4	CD25CD8
NS	ND	0	ND**	ND	ND	ND
I_0	41	3.1	ND**	0.9	0.9	4.1
IC_{50}	0.04	0.66	ND**	0.38	11	0.4
R^2	0.9845	0.9897	ND**	0.9964	0.9851	0.9970
I_{max}	50	3.2	ND**	56	22	37

ND**, absence of the antibody during the determination.



WLP7

PK	NFAT1	IL2CD4	IL2CD8	CD25CD3	CD25CD4	CD25CD8
NS	37	0.1	1.7	4.3	6.1	0.2
I_0	91	51	23	7.5	8.7	0.9
IC_{50}	0.30	1.1	1.3	0.46	0.84	0.36
R^2	0.9995	0.9928	0.9858	0.9776	0.9937	0.9971
I_{max}	39	0.6	7.1	73	77	44

WLP8

PK	NFAT1	IL2CD4	IL2CD8	CD25CD3	CD25CD4	CD25CD8
NS	75	0.1	29	3.1	3.8	0.1
I_0	87	16	30	15	14	8.4
IC_{50}	1.2	1.8	1.8	0.23	0.53	0.27
R^2	0.8680	0.9437	0.9627	1.000	0.9942	0.9782
I_{max}	60	1.3	57	46	67	45

WLP9

PK	NFAT1	IL2CD4	IL2CD8	CD25CD3	CD25CD4	CD25CD8
NS	111	0	0.4	1.1	1.6	0
I_0	176	24	3.3	7.5	12	4.8
IC_{50}	0.49	1.2	1.9	0.88	0.43	0.38
R^2	1.000	0.9759	0.9596	0.9998	0.9816	0.9937
I_{max}	85	0.3	9.1	72	52	71



WLP10

PK	NFAT1	IL2CD4	IL2CD8	CD25CD3	CD25CD4	CD25CD8
NS	133	0	28	0	0.2	0
I_0	753	33	72	6.6	8.1	0.3
IC_{50}	0.27	3.6	4.2	0.18	0.56	1.8
R^2	1.000	0.9568	0.9996	0.9734	0.9944	0.9167
I_{max}	97	4.2	83	55	54	67

WLP11

PK	NFAT1	IL2CD4	IL2CD8	CD25CD3	CD25CD4	CD25CD8
NS	93	0	20	4.8	4.9	0.4
I_0	123	37	40	18	14	0.8
IC_{50}	0.18	2.8	2.5	9.4	17	31
R^2	0.9605	0.9821	0.9998	0.9943	0.9570	0.9671
I_{max}	75	0.3	20	25	44	28

WLP12

PK	NFAT1	IL2CD4	IL2CD8	CD25CD3	CD25CD4	CD25CD8
NS	ND*	0	0.1	ND*	ND*	ND*
I_0	62	27	3.0	10	10	13
IC_{50}	0.37	13	9.0	0.12	2.4	2.9
R^2	0.9967	0.9715	0.9507	0.9885	0.9845	0.9842
I_{max}	59	0.6	0	7.8	5.0	1.6



WLP13

PK	NFAT1	IL2CD4	IL2CD8	CD25CD3	CD25CD4	CD25CD8
NS	83	0	76	1.0	0.5	0
I_0	105	13	82	10	7.7	1.9
IC_{50}	ND*	0.07	0.28	1.3	20	25
R^2	ND*	0.9994	0.9983	0.9602	0.9877	0.9888
I_{max}	80	0.3	84	39	4.2	26

WLP14

PK	NFAT1	IL2CD4	IL2CD8	CD25CD3	CD25CD4	CD25CD8
NS	ND*	ND*	ND*	ND*	ND*	ND*
I_0	34	2.2	0.3	ND*	ND*	ND*
IC_{50}	ND*	1.8	ND*	ND*	ND*	ND*
R^2	ND*	1.000	ND*	ND*	ND*	ND*
I_{max}	ND*	0	ND*	ND*	ND*	ND*

WLP15

PK	NFAT1	IL2CD4	IL2CD8	CD25CD3	CD25CD4	CD25CD8
I_0 NS	ND	0.6	0.4	ND*	ND*	ND*
I_0	177	17	9.0	ND*	ND*	ND*
IC_{50}	0.18	0.55	0.99	ND*	ND*	ND*
R^2	0.9918	0.9959	0.9781	ND*	ND*	ND*
I_{max}	21	0.6	0.9	ND*	ND*	ND*



WLP16

PK	NFAT1	IL2CD4	IL2CD8	CD25CD3	CD25CD4	CD25CD8
I_0 NS	115	0	34.7	2.1	2.7	0
I_0	217	46	12	4.1	6.9	1.0
IC_{50}	0.16	2.0	2.3	1.9	0.60	0.21
R^2	0.9436	0.9890	0.9858	0.9009	0.9981	0.9036
I_{max}	47	0.2	19.5	78	48	40

Values very low, proximal to LOD.

WLP17

PK	NFAT1	IL2CD4	IL2CD8	CD25CD3	CD25CD4	CD25CD8
I_0 NS	88	0	25	3.1	5.0	0.2
I_0	130	45	33	5.2	6.1	1.8
IC_{50}	ND*	2.2	5.6	2.5	1.5	1.8
R^2	ND*	0.9631	0.9881	0.9853	0.9728	0.9732
I_{max}	79	0.4	3.9	39	51	11

WLP18

PK	NFAT1	IL2CD4	IL2CD8	CD25CD3	CD25CD4	CD25CD8
I_0 NS	ND	0.3	0.1	ND*	ND*	ND*
I_0	125	13	5.2	ND*	ND*	ND*
IC_{50}	0.03	0.93	0.99	ND*	ND*	ND*
R^2	1.000	0.9647	0.9184	ND*	ND*	ND*
I_{max}	67	1.6	1.6	ND*	ND*	ND*

WLP19

PK	NFAT1	IL2CD4	IL2CD8	CD25CD3	CD25CD4	CD25CD8
I_0 NS	274	0	5.4	1.0	1.8	0
I_0	474	28	3.6	10	18	13
IC_{50}	1.7	1.5	1.9	7.1	3.4	5.1
R^2	0.9831	0.9431	0.9984	0.9977	1.000	1.000
I_{max}	67	0.7	2.8	16	12	7.4



S5.VALORISATION DES COMPÉTENCES, Nouveau Chapitre de la Thèse



Valorisation des compétences, NCT®

OFELIA NOCETI

2014

École Doctorale N°524: Biologie et Santé, Université de Limoges.

Mentor: Margueritte Rousselle

Étude de relations pharmacocinétiques, pharmacodynamiques et pharmacogénétiques des immunosuppresseurs anticalcineuriques : ciclosporine et tacrolimus chez les patients greffés du foie.



- ✓ *Date probable de présentation orale du « NCT »: 9 Octobre, 2014.*
- ✓ *Sujet académique de la thèse: Suivi Thérapeutique des Médicaments Immunosuppresseurs.*
- ✓ *Nom du directeur de thèse: Pr. Pierre Marquet.*
- ✓ *Date probable de soutenance de la thèse: 8 Décembre, 2014.*





Facultad de Medicina
Universidad de la República



Agencia Nacional de Investigación e Innovación



Liberté • Égalité • Fraternité

RÉPUBLIQUE FRANÇAISE

MINISTÈRE DES AFFAIRES ÉTRANGÈRES ET EUROPEENNES

ECOS-Sud

Programme de coopération ECOS-URUGUAY



Plan du Rapport

1. Cadre général et enjeux de thèse	279
1.1. Présentation succincte	279
1.2. La thèse dans son contexte. Le rationnel, les équipes et mes motifs personnels. 279	
1.2.1. Le rationnel	279
1.2.2. Les équipes.....	281
1.2.3. Raisons personnelles À ce travail de thèse	282
2. Déroulement, gestion et coût du projet	284
2.1.Préparation et cadrage du projet.....	284
2.1.1 Les partenaires.....	285
2.1.2 Questions éthiques... ..	286
2.2.Conduite du projet.....	286
2.3.Estimation et prise en charge du coût du projet.....	292
3.1.Compétences scientifiques et techniques	294
3.2.Compétences liées À la gestion d'un projet sur cinq ans	295
3.2.1. Management du projet.....	295
4. Résultats, impact de la thèse.....	296
4.1.Résultats	296
4.1.1.Impact pour le laboratoire, la recherche et la société.....	296
4.1.2.Impact personnel	297
5. Conclusions	298



1. Cadre général et enjeux de thèse

1.1. Présentation succincte

Même jusqu'à aujourd'hui, le dosage de posologie des immunosuppresseurs chez les patients transplantés d'organes solides, reste un sujet difficile. Les patients montrent des complications liées à son état sur ou sous immunosupprimé, c'est-à-dire ils développent des effets indésirables, comme rejet au greffon, infections, toxicités, maladies cardiovasculaires et néoplasies. Le propre de l'immunosuppression est de maintenir la réponse immunitaire basse pour éviter le rejet du greffon.

L'approche classique pharmacocinétique vers la détermination des concentrations résiduelles dans le sang est bien connue. Elle est insuffisante pour expliquer ces observations de complications. Pour cette raison plusieurs chercheurs ont mis leurs efforts dans le domaine pharmacodynamique afin de trouver des « biomarqueurs » capables d'être fiables pour le suivi de ce type de médicaments et aussi des réponses cliniques. Pour l'instant il n'existe pas de consensus sur lequel ou lesquels les « biomarqueurs » sont les plus pertinents.

Le but de cette thèse est d'aider à répondre aux questions relatives à l'influence des facteurs génétiques du patient, et quels marqueurs pharmacodynamiques et paramètres cinétiques sont liés à la réponse clinique.

Avec cette recherche nous avons l'intention de trouver les marqueurs qui sont plus utiles pour répondre aux besoins de chaque patient en particulier.

1.2. La thèse dans son contexte. Le rationnel, les équipes et mes motifs personnels.

1.2.1. Le rationnel

Cette thèse est tout à fait pionnière au niveau international car c'est la première fois qu'une étude prend la cascade de la « calcineurine » cible de ce groupe des immunosuppresseurs, avec une approche multifactorielle, et cela mérite d'être noté.



Les patients transplantés doivent prendre ces médicaments immunosuppresseurs pendant toute leur vie pour éviter le rejet du greffon; il est bien connu qu'il y a une grande variation inter individuelle et intra individuelle aux effets de ces médicaments. Sous la même posologie, les patients ne répondent pas de la même manière, il y a quelques uns qui expriment des événements indésirables, d'autres pas.

En raison de ce traitement de nombreux effets indésirables se produisent, comme la néphrotoxicité, les maladies cardiovasculaires, les désordres lymphoprolifératifs, l'apparition des autres tumeurs malignes, et les infections ; tous responsables des complications post-greffe, et allant même jusqu'au décès.

Jusqu'à présent, il n'existe pas d'outils pour prévoir ces événements ou les ajuster d'une manière plus précise et assurer leur niveau d'immunosuppression exact requis par chaque patient. C'est pourquoi des marqueurs pharmacodynamiques peuvent devenir de tels outils. La pharmacogénétique à travers de l'étude des polymorphismes des protéines impliquées contribuera également à expliquer les sources potentielles de la variabilité des résultats observés entre les patients.

En général, les résultats de l'étude auront l'intention de :

Identifier la meilleure batterie de marqueurs pharmacodynamiques de la transplantation hépatique.

Mettre en place un protocole pour la mesure de ces marqueurs.

Déposer des brevets pour ces marqueurs et/ou des méthodes de mesure.

Publier les résultats dans des revues internationales spécialisées.

Diffuser les innovations dans des conférences internationales.

Surveiller les patients transplantés et optimiser le traitement en routine clinique.

Pour développer l'étude, cette thèse a conçu le besoin de monter un essai clinique. Il s'agit de l'essai 3PIGREF (Étude de relations pharmacocinétiques, pharmacodynamiques et pharmacogénétiques des immunosuppresseurs anticalcineuriques: Ciclosporine et Tacrolimus chez les patients greffés du foie) composé de trois cohortes de sujets: les volontaires sains, les patients en liste d'attente de greffe et les patients transplantés du



foie. La cohorte des volontaires sains place la ligne de base des marqueurs choisis et apporte des connaissances à cet égard. Les patients inclus sur liste d'attente permettront de comparer la variation du début et pendant le suivi à différentes périodes post transplantation. Les patients transplantés nous aideront à mieux comprendre la variabilité inter individuelle.

La thèse fait l'objet d'une convention de cotutelle entre l'Université de Limoges en France et l'Université de la République en Uruguay. Les laboratoires de recherche impliqués sont l'Unité INSERM UMR S850 de Pharmacologie des Immunosuppresseurs et de la Transplantation de la Faculté de Médecine dirigé par Monsieur le Pr. Pierre Marquet et l'Unité de Biologie Moléculaire de la Faculté de Chimie en Uruguay, dirigée par Madame la Pr. Patricia Esperón.

Ce travail de recherche a été financé essentiellement sur le budget propre de l'UMR850 INSERM de Limoges, et de la Faculté de Chimie à l'Uruguay ; ainsi vers la bourse ANII, la bourse du gouvernement français et la subvention ECOS-SUD.

Les échantillons de sujets sains ont été sélectionnés parmi ceux de la collection biologique déclarée du CHU Limoges ; les patients en liste d'attente et transplantés sont suivis au Service des Maladies de Foie et au Centre National de Transplantation Hépatique à Montevideo.

L'étude des volontaires sains a été conduite à Limoges et celle des cohortes de patients à Montevideo.

À Montevideo, je conduis ma recherche dans le Département de Médecine Fondamentale de la Faculté de Médecine de l'Université de la République où je fais de la culture cellulaire et de la cytométrie en flux ; les essais pharmacogénétiques sont partagés entre l'Unité de Biologie Moléculaire de Montevideo et l'Unité INSERM de Limoges.

1.2.2. Les Équipes

L'Unité INSERM UMR S850 dirigée par le Pr. Pierre Marquet, avec une expertise bien reconnue dans les domaines pharmacocinétique et pharmacogénétique, m'a permis de bien formuler le rationnel de la thèse et focaliser sur la réponse pharmacodynamique aux anticalcineurines. L'hypothèse de travail représentait un défi car il s'agissait d'entrer



dans les domaines de l'immunologie et de la signalisation cellulaire, champs qui n'avaient pas encore été explorés dans l'unité de recherche.

La cytométrie en flux pour la détermination des marqueurs pharmacodynamiques, c'était un autre défi. Je n'ai jamais fait de culture cellulaire ou de cytométrie en flux au cours de ma carrière, cela m'a obligé à commencer rapidement ma formation dans cette discipline afin de traiter et analyser mes échantillons.

L'UMR 5164 CNRS, à l'Université de Bordeaux Segalen, nous a transféré le protocole pour étudier la translocation du NFAT1 au noyau des cellules, méthode développée par Monsieur le Pr. Jean-Luc Taupin.

L'UMR 7276 CNRS, à l'Université de Limoges nous a donné accès à sa plateforme de cytométrie en flux pour étudier la cohorte des volontaires sains.

Comme je n'avais aucune expertise en biologie moléculaire jusqu'à ce moment il m'a fallu me former aussi dans ce domaine. Donc l'Unité de BIOLOGIE MOLÉCULAIRE À Montevideo, et également l'UMR850 INSERM à Limoges m'ont apporté leur expérience dans les domaines du séquençage, du génotypage et de l'expression des gènes.

Tandis que le CENTRE NATIONAL DE TRANSPLANTATION DE FOIE EN URUGUAY, avec toute son expertise, contribue par le recrutement des patients et sa connaissance clinique des maladies.

1.2.3. Raisons personnelles à ce travail de thèse

Immédiatement après l'obtention de mon diplôme de pharmacienne en 1999, l'idée de faire des études de doctorat est arrivée, cependant ma vie professionnelle ne me permettait pas un tel engagement. C'est pourquoi je l'ai mis hors de mon champ de vision jusqu'en 2009. Quoi qu'il en soit, je n'ai aucun regret, car si j'avais commencé mon doctorat en 1999, le sujet de thèse se serait orienté vers la pharmacocinétique classique, alors que le sujet choisi est maintenant très actuel et original. Mon expérience en pharmacie clinique à l'Unité de Suivi Thérapeutique et au Centre Hospitalier Universitaire de Transplantation de Rein et Pancréas à Montevideo en 2008, et le contact avec le Centre National de Transplantation du Foie à Montevideo au tout début de 2009,



m'avaient inspiré la question suivante : comment aider les patients avec leur traitement immunosuppresseur? On les voit en routine et on s'aperçoit de leurs problématiques; mais en fait c'était d'abord Dieu qui m'a lancé dans ce voyage. Je n'ai aucune condition, mais seulement ma foi, c'est un rêve que j'ai poursuivi.

Le Directeur de la Direction Nationale de la Santé de l'Armée, avec lequel je travaille régulièrement, m'avait suggéré de contacter la Chef du Service des Maladies et Transplantation de Foie. J'ai débuté mon bénévolat avec l'implémentation d'un programme de pharmacie clinique chez les patients adultes et pédiatriques pour détecter des événements indésirables, les interactions médicamenteuses, le manque d'adhérence aux médicaments, etc., et je l'ai fait jusqu'au la fin de l'année 2009.

Afin de poursuivre mes recherches sur l'utilisation de biomarqueurs en transplantation, j'avais besoin d'un directeur de thèse qui voulait me conduire et m'encadrer. C'était en 2008 lorsque Mr. le Pr. Pierre Marquet a été invité pour une conférence à Montevideo, Uruguay, que je lui ai parlé de mon intérêt sur les biomarqueurs et après quelques échanges il a accepté ce mentorat, et de me suivre. Une fois que l'idée a été présentée, et le compromis acquis, j'ai eu une bourse de l'Agence Nationale de la Recherche et l'Innovation en Uruguay pour financer mes études de doctorat à l'étranger, dans le chapitre Génomique Intégré.

Mais il me fallait encore trouver la contrepartie académique au niveau national; je me suis inscrite à la Faculté de Chimie à Montevideo et je me servais d'une convention précédente entre les Universités de Limoges et de la République. Madame la Pr. Patricia Esperón de l'Unité de Biologie Moléculaire de la Faculté de Chimie, Université de la République a accepté d'être ma co-directrice de thèse. J'ai en 2010 aussi postulé à une bourse de coopération scientifique du gouvernement français.

Le déroulement de la thèse à Montevideo à été un peu difficile, parce que je ne disposais pas d'un laboratoire propre équipé avec toutes les infrastructures nécessaires pour la réalisation des études proposées. Le pays lui-même n'était pas préparé por cette recherche. L'Institut Pasteur m'avait rejetée ainsi que l'Institut d'Hygiène de la Faculté de Médecine de l'Université de la République; ces échecs avaient retardé mes études deux ans. Finalement, j'ai réussi à faire ma recherche dans le Département de Médecine



Fondamentale de la Faculté de Médecine de l'Université de la République, à l'Hôpital Universitaire grace a l'effort de la Pr. Esperón.

Du point de vue scientifique le sujet de thèse est très intéressant et aussi l'approche proposée; c'est la première fois que le problème est abordé d'une manière multifactorielle. C'était une occasion pour me former dans des domaines complètement nouveaux pour moi, qui m'enrichiront et de vivre une expérience dans une université française. Comme j'avais appréhendée quelques années auparavant le domaine de la langue française, je pensais que cela m'aiderait encore. Personnellement être loin de ma famille certains mois de l'année était un peu dur, mais ça valait le coup à chaque instant. Récemment, en Août 2013, j'ai pue effectuer mon transfert vers le Service de Maladies de Foie et le Centre National de Transplantation Hépatique, bien que cela représente une baisse de salaire importante parce que j'ai dû abandonner mon poste de chef de service.

Mais je n'ai que des mots de remerciements pour le soutien, les possibilités de formation et la partie humaine des membres de l'INSERM et du CHU de Limoges. Cette opportunité a été incroyable, même avec toutes les difficultés rencontrées. Je suis privilégiée de travailler dans cette équipe. Officialiser ma transfert au SERVICE DES MALADIES DE FOIE ET DE TRANSPLANTATION HÉPATIQUE après 5 ans, a aussi été un autre défi, cependant aujourd'hui j'y suis avec ce lien d'appartenance.

Déroulement, gestion et coût du projet

Préparation et cadrage du projet

Le sujet choisi devait être travaillé plus en détail pour définir le champ d'application. L'Unité INSERM possède une vaste expérience dans les domaines de la pharmacocinétique et la pharmacogénétique des immunosuppresseurs qui pouvait parfaitement soutenir la recherche proposée, même si la partie pharmacodynamique était un nouveau champ à explorer.



Il fallait aussi prévoir le budget et construire des collaborations pour me former aux méthodes de cytométrie en flux. Il y avait eu une recherche précédente à l'Université de Toulouse qui n'a pas pu aboutir pour des raisons personnelles et professionnelles du chercheur et du directeur de thèse.

Il fallait repartir et reprendre la partie qui nous intéressait, inclure des éléments qui pourraient ajouter de la valeur de recherche pour aboutir à l'analyse du système complexe envisagé.

Les partenaires

Les partenaires impliqués, comme mentionnés dans les paragraphes précédents, sont:

L'Unité INSERM UMR 850 À Limoges, France

Le SERVICE DE PHARMACOLOGIE ET TOXICOLOGIE du CHU Limoges, France

Le CNRS UMR 7276, de l'Université de Limoges, France.

Le CNRS UMR 5164, de l'Université de Bordeaux Segalen, France et le CHU de Bordeaux, France.

L'UNITÉ DE BIOLOGIE MOLÉCULAIRE, de la Faculté de Chimie de l'Université de la République à Montevideo, Uruguay.

Le DÉPARTEMENT DE MÉDECINE FONDAMENTAL de la Faculté de Médecine du CHU de l'Université de la République à Montevideo, Uruguay

Le SERVICE DES MALADIES DE FOIE ET LE CENTRE NATIONAL DE TRANSPLANTATION HÉPATIQUE à Montevideo, Uruguay

L'AGENCE NATIONALE DE LA RECHERCHE ET L'INNOVATION À Montevideo, Uruguay

Le PROGRAMME DE COOPÉRATION ECOS SUD: France - Uruguay

Le SERVICE DE COOPÉRATION SCIENTIFIQUE DE L'AMBASSADE DE FRANCE À Montevideo, Uruguay



Questions éthiques

Toutes les données recueillies pour ma thèse, sont strictement confidentielles et anonymes. Cela est clairement stipulé dans les notes informatives, consentement informés et le protocole de recherche.

Conduite du projet

La première étape a consisté à faire une revue de la littérature afin de vérifier l'état de la question et de bien définir une problématique qui reste assez large. à partir de là, les objectifs de la recherche ont été ajustés.

La chronologie de ce projet de thèse est la suivante:

2009: inscription à la Faculté de Chimie en Uruguay, candidature à une bourse de l'Agence Nationale de la Recherche et l'Innovation, signature de la convention de cotutelle, inscription à l'Université de Limoges. Réalisation des cours supplémentaires pour obtenir les crédits exigés par la Faculté de Chimie à Montevideo.

2010: Premier stage à Limoges. Évaluation scientifique exhaustive concernant les sources de variabilité pharmacocinétiques, pharmacodynamiques et pharmacogénétiques aux médicaments immunosuppresseurs. J'ai aussi travaillé sur les principes fondamentaux de la modélisation pharmacocinétique et pharmacodynamique. Rédaction de l'avant projet du protocole de recherche clinique. Initiation à la cytométrie en flux. Mise en place des protocoles analytiques dans le sang total pour mesurer IL-2 intracellulaire, CD25 dans des conditions de prolifération des lymphocytes, et l'inhibition de la translocation de NFAT1 dans le noyau. Stage au Laboratoire d'Immunologie de l'Université de Bordeaux, pour le transfert du protocole d'analyse du NFAT1.

Les principaux résultats obtenus dans la période on été la connaissance de la voie d'activation des lymphocytes jusqu'au la transcription des cytokines afin de définir les étapes critiques pour la surveillance des immunosuppresseurs et de faire la corrélation



avec la réponse clinique; la vérification des biomarqueurs pharmacodynamiques potentiels liées aux rejet aigus et chroniques dus à l'insuffisance de traitement immunosuppresseur ; la coopération académique avec les universités de Toulouse et Bordeaux ; l'utilisation autonome de la cytométrie de flux ; la validation des protocoles d'analyse pour la détermination des biomarqueurs. En fait, ce projet est à la pointe de la recherche en Europe sur ce sujet. C'est un casse-tête entre l'immunologie, la biologie moléculaire et la signalisation cellulaire, où l'approche pharmacodynamique traite de biomarqueurs capables de prédire le rejet et les effets secondaires, où la pharmacocinétique cible l'inactivation de l'enzyme calcineurine et la translocation du facteur de transcription NFAT1, et la pharmacogénétique participe par les isoformes susceptibles d'être exprimées.

Il y a eu une avancée par des expériences très positives dans tous les aspects en raison de la qualité de l'UNITÉ et de ses ressources; l'excellente disposition et la position stratégique du directeur de thèse à encadrer, générer des collaborations et de promouvoir ce projet; une question d'opportunité: le temps de stage me semblait très court, personnellement j'aurais aimé plus de temps afin de mieux tirer parti de toutes les possibilités qui pouvaient s'ouvrir à moi.

2011: Rédaction du protocole de recherche clinique à Montevideo dans la deuxième partie de l'année 2010, soumis et approuvé par les comités d'éthique des hôpitaux et de l'Université. Mise à jour de la littérature concernant les biomarqueurs en transplantation. Redéfinition des marqueurs à mesurer, en raison de l'évidence scientifique publiée. Stage dans le Laboratoire d'Immunologie et immunogénétique au CHU Limoges pour réaliser les déterminations par cytométrie en flux (300 h).

Développement et validation de protocoles d'analyse des biomarqueurs redéfinies chez les volontaires sains: IL-2 intracellulaire, CD25 dans des conditions de prolifération des lymphocytes, NFAT1 sur les cellules mononuclées du sang périphérique, TCR $\alpha\beta$ - $\gamma\delta$ et FOXP3 Tregs sur des lymphocytes. Remplissage de la base de données conçue à Montevideo avec les premiers résultats obtenus à Limoges chez les volontaires sains.

Les principaux résultats obtenus: la connaissance des biomarqueurs essentiels capables de refléter la variabilité interindividuelle des effets immunosuppresseurs; l'expertise en cytométrie de flux et d'autres techniques immunologiques acquises; la validation des



protocoles d'analyse pour la détermination de biomarqueurs. D'autres aspects positifs: la coopération universitaire avec le CHU Limoges et le soutien financier exclusif pour ce projet donné par l'Unité INSERM UMR850 jusqu'à ce moment. Mais à Montevideo, on a rencontré des difficultés pour la poursuite de cette recherche, à cause de la charge importante du temps consacré pour l'accomplir, plus de 3 jours par semaine – (36 h de travail pour préparer les échantillons, incuber les PBMC et les lire par cytométrie en flux)-, il était très difficile en 2010 et même en 2011, de trouver un laboratoire à Montevideo qui me permette de développer ce type de recherche.

Plusieurs établissements universitaires ont été contactés; l'un d'entre eux a signé un contrat, mais après les premiers essais, il a décidé de ne pas aller plus loin en raison de l'utilisation intensive de leurs installations. Les deux autres ont fait à peu près la même chose. Ainsi, durant le premier trimestre 2011, il était impératif de commencer le processus, au moins chez des volontaires sains en France, et cela a été fait. Dans l'étape suivante, j'ai essayé de trouver une place au CHU à Montevideo pour préparer les échantillons et les incuber, mais la réponse d'une autre institution universitaire sur l'utilisation de leur cytomètre pour faire les lectures était toujours en attente. Une autre question importante était liée à l'absence de financement. L'Université à Montevideo, grâce au Programme PEDECIBA ne dispose qu'USD 800 par étudiant et par an. Ce montant dans mon cas ne couvre qu'un seul flacon de 2 ml d'un anticorps! Alors que la recherche nécessite d'utiliser au moins 13 types d'anticorps en même temps pour chaque patient ou volontaire. C'est pour l'instant, l'UMR 850 de Limoges qui a entièrement financé cette recherche pour laquelle elle a dépensé environ € 60,000! Cette situation dans son ensemble a retardé la recherche d'au moins 6 ou 8 mois, de sorte qu'il n'a pas été possible de terminer le doctorat en 3 ans comme prévu. À cet égard, et afin de faire le suivi avec le PDG de la ANII j'ai eu une réunion pour expliquer les raisons des difficultés exposées avant et pourquoi l'Uruguay n'est pas en mesure de mener ce sujet qu'il était censé faire.

Les résultats que nous avons obtenus chez des volontaires sains étaient la première preuve scientifique qui expliquait pourquoi les cliniciens voient cette variabilité entre les individus. Nous avons trouvé une grande variabilité de réponse chez des volontaires sains, à l'appui des observations cliniques chez les patients. Il reste à confirmer ces résultats chez les patients, en utilisant la même batterie de tests. La valeur ajoutée de



cette recherche est d'utiliser ces biomarqueurs chez les patients sur la liste d'attente de transplantation, pour savoir quelle dose d'anticalcineurine est la plus appropriée, pour chacun d'eux, dès le début du traitement.

2012: On a étudié la variabilité intra-individuelle chez 4 volontaires sains pendant 3 semaines consécutives. Nous avons évoqué la possibilité de faire une étude d'expression des ARN messagers des protéines impliquées, en parallèle dans les mêmes conditions que les biomarqueurs immunologiques.

Pour l'étude des polymorphismes, une liste avec 64 SNPs candidats liés à la voie calcineurine a été élaborée. On n'a conservé que les variantes génétiques citées dans plus d'une publication scientifique, avec une association positive et statistiquement significative avec la maladie ou le phénotype étudié. Nous avons sélectionnés les variantes du promoteur ou de la région codante, avec une fréquence allélique supérieure ou égale à 10%. La cohorte de 30 volontaires sains et 48 patients inclus jusqu'à ce moment ont alors été testés pour les SNPs sélectionnés comme pertinents. Les analyses ont été effectuées en utilisant des techniques de séquençage et de génotypage, et dans certains les deux pour confirmation. On a aussi conçu l'étude des régions de liaison entre les domaines critiques des protéines associées à la voie de la calcineurine; nous avons examiné s'il y avait des SNPs d'intérêt dans ces régions. La conception de la base de données pour l'analyse des résultats était en cours, la base structurée a été créée, puis alimenté pendant l'étude. Le calcul de la puissance liée au nombre de sujets et du nombre de SNPs à tester a été fait. On s'est servi du logiciel R pour l'analyse et la modélisation des systèmes biologiques. On a fait l'analyse préliminaire des données et les relations PD - PG chez les volontaires sains et certains patients.

J'ai participé à la troisième édition des Journées Thématiques obligatoires de l'école doctorale de biologie et santé (Module « bio statistique de la transcriptomique »). J'ai eu aussi l'opportunité de participer à l'atelier de formation INSERM « Transcriptomes non codants révélés par séquençage des ARN» à Bordeaux. J'ai aussi insisté à prendre la « Formation des opérateurs en BD FACS CANTO II et FACSDiva 6.1.3 » chez Beckton Dickinson, Paris; et les autres formations obligatoires d'« identification des compétences et des aptitudes personnelles et sa valorisation vers la recherche, comment



gérer ses projets personnels ». J'ai présenté mes premiers résultats dans le 7ème Congrès de la Société Française de Physiologie, Pharmacologie et Thérapeutique dans une session de présentations orales courtes, à Dijon.

On a discuté en profondeur sur l'article à publier et son chemin de publication, la discussion de l'examen de la voie de la calcineurine, les résultats chez les patients, et une autre lié à des sources génétiques de variabilité de la voie calcineurine.

Certains résultats ont dû être répétés à Montevideo afin de soumettre le manuscrit. On a fait la relecture du projet de thèse finale, pour valider le processus et corriger ou améliorer les domaines de possibilité de recherche, et de l'ajuster chaque année.

Comme résultats obtenus je peux citer: l'amélioration de mon expertise en cytométrie en flux, la formation BD a marqué le point d'inflexion. J'ai pu avancer vraiment dans le domaine pharmacogénétique de l'étude. J'ai commencé à relier les résultats pharmacodynamiques et pharmacogénétiques. J'ai acquise une expertise dans les techniques génétiques. J'ai eu une meilleure connaissance des sources de variabilité de la voie calcineurine.

A ce moment, le soutien financier exclusif pour le projet sur le budget de l'Unité INSERM UMR850 s'élevait à 80.000 €. Le projet a été soumis au fonds scientifique du Conseil Régional du Limousin en France et à l'appel de recherche de l'ANII à Montevideo "Fondo María Viñas 2012", pour son financement, mais sans succès dans ce dernier cas. On a obtenu l'approbation pour la période 2012-2014 de notre soumission au programme de coopération scientifique ECOS Sud 2011.

Mais nous avons encore rencontré des difficultés pour la poursuite de cette recherche en Uruguay: la situation liée à l'utilisation du cytomètre en flux était complexe, en raison de la charge du travail: 3 longues journées par semaine. Les seuls équipements qui étaient compatibles avec ces mesures à Montevideo étaient situés à l'Institut Pasteur, à l'Institut d'Hygiène dans le Département de Biotechnologie et dans un centre hospitalier privé; à cette période, nous n'avons pas l'autorisation de continuer à utiliser le cytomètre de l'Institut d'Hygiène de la Faculté de Médecine, de sorte que la recherche a dû être arrêtée pour un temps.



Cette situation a retardé et continuera à retarder la recherche encore plus, donc il ne sera pas possible de terminer le doctorat comme prévu. Une 4ème année sera nécessaire pour compléter et publier ce programme de recherche. L'idée était de compléter l'inclusion de tous les patients pendant 2012, et les surveiller sur 2013; mais s'il n'y a pas la volonté de la communauté universitaire à coopérer, la recherche devra être tronquée.

Nonobstant, on a pu démontrer la liaison entre les biomarqueurs de la voie calcineurine

2013: On a fait la modélisation pharmacodynamique et pharmacogénétique chez les volontaires sains. Un premier manuscrit a été soumis à l'American Journal of Transplantation, mais il n'a pas été accepté car la cohorte n'incluait pas de patients, seulement des volontaires sains. L'article a été reformulé avec l'ajout des résultats de pharmacogénétique, et on l'a soumis à Journal of Clinical Pharmacology and Therapeutics, à nouveau sans succès. Pendant ce temps, on a étudié la faisabilité du protocole d'étude de l'expression des gènes de la voie calcineurine, pour faire le suivi des patients en liste d'attente de transplantation et des patients transplantés. On a fait l'analyse statistique et la modélisation des systèmes biologiques avec le logiciel R chez la cohorte des volontaires sains, et chez 20% des patients transplantés prévus, afin de regarder si on trouvait une tendance avec les résultats préliminaires. J'ai suivi une formation INSERM concernant les nouvelles applications de la cytométrie en recherche fondamentale et clinique (cytométrie par spectrométrie de masse) à Bordeaux. J'ai aussi participé au 4ème atelier de pharmacogénétique, GIRCI à Limoges. Je me suis renseigné sur l'utilisation du logiciel de modélisation pharmacocinétique pour ajuster les médicaments immunosuppresseurs et des antibiotiques de marge thérapeutique étroite, par les estimateurs Bayésiens au CHU Limoges. J'ai réussi à me former sur le logiciel d'analyse de données par cytométrie en flux INFINICYT Cytognos par webinars sur mesure. J'ai eu la chance d'obtenir une bourse pour participer au treizième congrès international de suivi thérapeutique des médicaments et toxicologie clinique (IATDMCT) à Salt Lake City, Utah, États-Unis, où j'ai fait une communication orale courte de mes résultats chez les volontaires sains.



J'ai deux articles de revue de littérature en cours de rédaction. On a fait le point sur le statut de la thèse, afin de corriger ou d'améliorer les domaines de possibilité de recherche. On a prévu comme date de soutenance de thèse la fin 2014.

Comme résultats de cette période: l'amélioration de l'expertise en cytométrie en flux multiparamétrique; l'avancement dans la partie pharmacogénétique et pharmacogénomique de l'étude; l'amélioration de la connaissance des sources de variabilité de la voie calcineurine; la présentation de l'article avec des résultats pharmacodynamiques et pharmacogénétiques originaux; la définition des documents supplémentaires à présenter; le soutien financier exclusif pour ce projet donné par l'Unité INSERM UMR 850 s'élevant à 95.000 € à ce jour. Les difficultés d'infrastructure à Montevideo, décrites dans le rapport de l'année précédente ont été finalement surmontés car le Département de Médecine Fondamentale de la Faculté de Médecine au CHU à Montevideo m'a permis de développer ma recherche dans ses installations vers une collaboration établie.

2014: L'inclusion de toute la cohorte des patients transplantés et en liste d'attente avec suivi sérié. Finalisation de la génétique et la transcriptomique. Soumission de l'étude chez les volontaires sains au Journal of Clinical Chemistry, article publié.

Estimation et prise en charge du cout du projet



	Nature de la dépense	Détails *		Coûts totaux (euros TTC)			
				Nombre d'unités	Coût unitaire moyen	Quote-part utilisation	Total
1	Ressources Humaines	Salaire brut	Charges				
1.1	Docteurant						
	<i>Bourse ANII 3 années</i>			13,5	21.500	100%	21.500
	<i>BGF 3 années (3 mois le 1er et 2ème année et 2 mois le 3ème)</i>			8	6.000	100%	6.000
	<i>PEDECIBA, UdelAR (Billet d'avion stage 2012)</i>				1.200	100%	1.200
	<i>Programme ECOS Sud (billet d'avion et stage 1 mois 2014)</i>			1	2.400	100%	2.400
	<i>Fonds personnels - Billets d'avion 2011 et 2013 plus compléments de stage et billets d'avion 2012 et 2014</i>				5.000	100%	5.000
1.2	Encadrant 1 - Directeur de Thèse Université de Limoges	10000		60	600.000	2%	12.000
1.3	Encadrant 2 - Co Encadrant Universidad de la República	2580		60	154.800	5%	7.740
1.4	Autre personnel (hors sous-traitance)						
	<i>Technicien INSERM</i>	2200		36	79.200	2%	1.584
	<i>Assistant G2 Universidad de la República</i>	1290		12	15.480	22%	3.406
	Sous-total Ressources Humaines				885.580		60.830
2	Consommables						
2.1	Fournitures expérimentales						
	Réactifs a usage unique						
	<i>Anticorps, milieu de séparation des cellules, activateurs</i>						69.252
	<i>Fluids cytométrie en flux</i>						4.050
	<i>Réactifs Biologie moléculaire</i>						162.276
	<i>Consommables plastiques</i>						8.000
2.2	Fournitures de bureau						
	<i>Cahiers, stylos, notes,</i>						200
	Sous-total Consommables						243.778
3	Infrastructures	Loyer brut	Charges locatives				
3.1	Entretien, gardiennage, secrétariat						
3.2	Loyers des locaux						
	<i>Frais d'usage du cyomètre chez l'Institut d'Hygiène à Montevideo</i>			23	23		529
	Sous-total Infrastructures				23		529
4	Matériel (amortissements)	Taux d'amortissem					
4.1	Matériel d'expérimentation (dont les ordinateurs et logiciels spécialisés)						
	<i>Enceinte de sécurité biologique</i>			2030	6.418	41%	2.610
	<i>Incubateur</i>			3698	4.015	25%	991
	<i>Centrifugeuse de Plaques</i>			194	9.489	4%	368
	<i>Hemocytomètre</i>			46	9.274	0,9%	86
	<i>Cytometre BD (Fortessa / Canto II 3 Lasers)</i>			212	163.226	4%	6.933
	<i>DIVA BD (Logiciel dédié)</i>				2500		2.500
	<i>Distributeur des échantillons Limoges</i>			10	37.097	0,2%	74
	<i>Thermocycleur</i>			139	5.194	2,8%	144
	<i>Rotor gene</i>			270	18.548	5,4%	1.003
	<i>Séquenceur</i>			1782	74.194	12%	8.828
	<i>Sequencher (Logiciel)</i>			470,3	2.500	9,4%	236
4.2	Ordinateur de bureau Limoges			13,5	800	25%	200
4.3	Logiciels de bureau Limoges			13,5		100%	
4.4	Autre						
	<i>Ordinateur portable personnel</i>				700	100%	700
	Sous-total Matériel				78.194		23.974
5	Déplacements	Transport	Hébergement+autres frais				
5.1	Missions en France	100	600		700		700
5.2	Missions à l'étranger	Non					
5.3	<i>Congrès en France - P2T 2010 Bordeaux , 2011 Grenoble , 2012 Dijon</i>	700	1350		2.050		2.050
5.4	<i>Congrès à l'étranger - IATDMCT: Stuttgart 2011, Salt Lake City 2013</i>	1500	1200		2.700		2.700
	Sous-total Déplacements				5.450		5.450
6	Formation						
6.1	Formations						
	<i>Ecole Doctoral: 1 Oléron, 2 Egletons</i>				750		750
	<i>Ateliers INSERM à Bordeaux - 2</i>	400	480		880		880
	<i>Cytométrie Limoges</i>						
	<i>Cytometrie BD Rungis / Paris - Remise sur l'inscription</i>	200	480		680		680
6.2	Autres frais (Inscription à l'Université, Sécurité Sociale étudiante, etc.)	Non					
	<i>Doctorat gratuit en Uruguay</i>						
	<i>Assurance médicale ANII</i>				758		758
	<i>Frais de sécurité sociale BGF</i>				2.280		2.280
	Sous-total Formation				2.310		5.348
7	Documentation et communication	Direct	Sous-traitance agence				
7.1	Affranchissements, Internet, téléphone						
	<i>Colis vers l'Uruguay (cahiers, réactifs)</i>						3.500
	<i>Dédouanement à Montevideo - Faculté de Chimie</i>						961
7.2	Publicité, communication, impressions				150		
7.3	Documentation (périodiques, livres, bases de données, bibliothèque, etc.)						
	<i>Livre cytométrie</i>				100		
	<i>Base de donnée BiblioINSERM</i>					10%	
	<i>Articles demandés à la bibliothèque</i>			10			
7.4	Autres						
	<i>Frais de publication articles scientifiques CPT</i>				90	100%	
	Sous-total Documentation et communication				250		4.461



8	Charges financières (intérêts des emprunts)						
	Sous-total Charges financières						
9	Charges exceptionnelles						
	Sous-total Charges exceptionnelles						
10	TOTAL				888.140		344.370

Compétences, savoir faire, qualités professionnelles et personnelles

Compétences scientifiques et techniques

Langue française : *amélioration de la langue française au niveau C1, après près de 25 ans sans la pratiquer.*

Pharmacologie : *maîtrise en pharmacodynamie et pharmacogénétique pour modéliser les biomarqueurs et les lier avec la réponse clinique.*

Revue de littérature : *maîtrise de l'organisation de l'information sur les différentes parties du sujet et de la base de données des articles.*

Culture cellulaire : *maîtrise de la technique pour développer les protocoles analytiques des biomarqueurs choisis.*

Cytométrie en flux : *maîtrise de la méthode pour acquérir des événements, analyser les résultats et standardiser le protocole et l'appareil. Maîtrise de l'usage de différents logiciels pour analyser les résultats obtenus.*

Biologie Moléculaire : *maîtrise en génétique et transcriptomique afin d'étudier les variantes génétiques par génotypage et séquençage, ainsi que pour l'expression des gènes. Connaissances de base des logiciels que permettent de dessiner des amorces et fragments de gènes, ainsi que d'analyser les résultats.*

Biostatistique : *connaissances de base pour faire des analyses multiparamétriques en composant principale, pour l'utilisation des packages sur le logiciel R et de GraphPad pour analyser les résultats avec des modèles non-paramétriques.*

Encadrement : *d'un étudiant pendant sa résidence pour obtenir son diplôme en biochimie.*



Compétences liées À la gestion d'un projet sur cinq ans

3.2.1. Management du projet

Conception et management d'un essai clinique comme chercheur principal. Validation analytique des biomarqueurs choisis.

Insertion dans un Service de Médecine, en particulier dans un centre de transplantation. En fait il s'agit d'une situation très particulière, car il n'est pas du tout commun pour un pharmacien de travailler en étroite collaboration avec les médecins et encore moins dans le même service. Je suis très clinique et très scientifique, cela donne à l'équipe une nuance importante. Même du point de vue de la qualité de la connaissance apportée.

3.2.2. Communication et valorisation des résultats :

Orale

Lors de 3 séminaires internes au laboratoire INSERM (France)

Lors de 3 séminaires à la Faculté de Chimie (Uruguay)

Lors de 1 colloque national (France)

Lors de 1 colloque international (États Unis)

Lors des enseignements effectués dans le Service de Maladies de Foie et Transplantation Hépatique (Uruguay)

Lors des échanges entre collègues (Uruguay)

Écrite

Comptes-rendus de communications orales

Rédaction de la thèse

Un article publié dans Clinical Chemistry (IF 7.9), deux autres articles en cours de rédaction



Qualités personnelles

Organisation, rigueur et responsabilité.

Motivation, dévouement, curiosité intellectuelle et technique.

Persévérance, engagement, leadership et exigence.

Résultats, impact de la thèse

Résultats

On a déjà montré des résultats originaux avec la cohorte des volontaires sains. Chez les patients, au moins d'un point de vue préliminaire, on constate que les marqueurs choisis nous permettent de prévoir comment le patient peut réagir aux médicaments immunosuppresseurs. On peut avertir le clinicien si le sujet présente un risque de développer des infections récurrentes, quelle est la dose la plus pertinente pour initier leur traitement et comment la génétique peut influencer sur la réponse clinique.

Impact pour le laboratoire, la recherche et la société

Pour le laboratoire INSERM à Limoges: cette thèse a permis de lancer un nouvel axe « biomarqueurs d'efficacité des inhibiteurs de la calcineurine » au sein de la thématique de pharmacodynamie des immunosuppresseurs de l'unité, qui comprend par ailleurs l'étude de leurs mécanismes d'actions néphrotoxiques et vasculotoxiques et l'étude des biomarqueurs précoces et non-invasifs des lésions du greffon rénal. La progression parallèle de ces trois axes est très originale et devrait permettre à l'unité de contribuer activement à l'objectif de médecine personnalisée en transplantation.

Pour le laboratoire de Biologie Moléculaire À Montevideo: cette thèse lui a permis d'ouvrir son champ d'exploration vers l'approche fondamentale à la clinique. Approfondir dans les aspects d'un recherche innovatrice, et et d'articuler la concrétion de ressources qui ne appartiennent pas au domaine de la biologie moléculaire, ainsi comme élargir l'horizon dans les sujets abordés dans la pharmacogène grâce À une pose non traditionnel.



Pour le Service des Maladies de Foie et le Centre National de Transplantation Hépatique: *cette recherche lui a permis d'acquérir plus de connaissances sur la gestion des traitements immunosuppresseurs pour mieux comprendre la grande variabilité inter et intra individuelles de la réponse.*

Pour la recherche: *cette étude a permis de vérifier des concepts qui jusqu'ici restaient hypothétiques.*

Pour la société, plus spécialement pour la population des greffés hépatiques ou en liste d'attente de transplantation: *nos résultats montrent qu'il est possible de prédire d'une manière plus précise la dose nécessaire d'immunosuppresseur ainsi que les facteurs prédisposant à des infections et à la toxicité, et de gérer le traitement en tenant compte de toute une batterie de facteurs.*

Impact personnel

Incroyable. J'ai beaucoup aimé ce que j'ai fait, malgré toutes les difficultés décrites et même non décrit. Je me suis lancée dans un domaine passionnant. A chaque fois qu'on se retrouve avec des résultats significatifs et qu'après on peut les vérifier dans la pratique clinique et les utiliser pour aider les patients et les cliniciens à prendre des meilleures décisions, c'est indescriptible. Je suis très heureuse de travailler dans un service de médecine, ce n'est pas courant qu'un pharmacien appartienne en dehors du service de pharmacie hospitalière. Je peux interagir directement dans les rounds médicaux multidisciplinaires et exprimer mon point de vue sur un patient en particulier. Je suis écoutée, respectée et la plupart du temps la décision finale prend en compte mon opinion professionnelle.

*En dehors de consolider ma position dans l'équipe, je n'ai pas encore envisagé l'avenir, mais je vais sans doute m'ouvrir le chemin pour approfondir dans le domaine de la transplantation et les maladies de foie comme le cancer de foie et les hépatites auto-immunes. La création d'un **centre de référence** pour le suivi de patients en transplantation est une idée que j'ai commencé à bâtir pour élaborer une projection idéale de voie professionnelle.*



Conclusions

Je voudrais remercier L'Intelli'Agence pour m'avoir acceptée dans son programme Nouveau Chapitre de Thèse (même à distance), et à laquelle j'ai eu l'opportunité de m'ouvrir et de partager ma propre expérience pendant ce voyage de thèse.

Le Nouveau Chapitre de Thèse m'a permis d'acquérir une vision globale de l'organisation de mes propres compétences.

Un remerciement tout spécial à Madame Maggie Rousselle pour sa disponibilité, sa patience et ses conseils, bien que je n'ai pas pu respecter les délais prévus.

